

**Windsor Board of Education  
Regular Meeting**

Wednesday, February 21, 2024 7:00 PM

BOE Regular Meeting, In-Person and Zoom Please click the link below to join the webinar:  
<https://us06web.zoom.us/j/83650712331> Or Telephone: +1 646 558 8656 +1 301 715 8592 Webinar ID: 836  
5071 2331

601 Matianuck Avenue  
Windsor, CT 06095

1. Call to Order, Pledge to the Flag, Moment of Silence  
**Speaker(s):** D. Furie
2. Recognitions/Acknowledgements  
**Speaker(s):** D. Furie
  - 2.a. Recognition - New BOE Student Representative - Sophia DiFelici  
**Speaker(s):** T. Hill/B. Parker
3. Audience to Visitors  
**Speaker(s):** D. Furie
4. Consent Agenda  
**Speaker(s):** D. Furie
  - 4.a. Financial Report  
**Speaker(s):** D. Batchelder
  - 4.b. Enrollment Report  
**Speaker(s):** D. Batchelder
  - 4.c. Food Service Report  
**Speaker(s):** D. Batchelder
  - 4.d. Human Resources Report  
**Speaker(s):** D. Batchelder
5. Approval of Minutes  
**Speaker(s):** L. Lockhart
  - 5.a. January 17, 2024 Regular Meeting  
**Speaker(s):** L. Lockhart
  - 5.b. January 23, 2024 Public Forum with Finance Committee  
**Speaker(s):** L. Lockhart
  - 5.c. January 30, 2024 Public Forum with Finance Committee  
**Speaker(s):** L. Lockhart
  - 5.d. February 6, 2024 Public Forum with Finance Committee  
**Speaker(s):** L. Lockhart
6. Student Representative Report  
**Speaker(s):** S. DiFelici
7. Board of Education  
**Speaker(s):** D. Furie
  - 7.a. President's Report  
**Speaker(s):** D. Furie
  - 7.b. Design Plan for Oliver Ellsworth Humidity Mitigation Program by van Zelm Engineers  
**Speaker(s):** D. Batchelder
  - 7.c. Finance Committee's Recommendation regarding the 2024-2025 Financial Plan and Adoption of the 2024-2025 Financial Plan (Anticipated Action)  
**Speaker(s):** L. Lockhart
  - 7.d. School Liaison Reports  
**Speaker(s):** D. Furie
    - 7.d.1. Windsor High School  
**Speaker(s):** A. Taylor/N. Wolliston
    - 7.d.2. Sage Park Middle School  
**Speaker(s):** A. King/P. Panos
    - 7.d.3. Clover Street School  
**Speaker(s):** J. Madison
    - 7.d.4. John F. Kennedy School  
**Speaker(s):** J. Canter
    - 7.d.5. Oliver Ellsworth School  
**Speaker(s):** L. Lockhart
    - 7.d.6. Poquonock School

**Speaker(s): J. Halek**

8. Superintendent's Report

**Speaker(s): T. Hill**

9. Committee Reports

**Speaker(s): D. Furie**

10. Other Matters/Announcements/Regular BOE Meetings

**Speaker(s): D. Furie**

10.a. Next BOE Regular Meeting is Tuesday, March 19, 2024, 7:00 PM, LPW, Board Room

**Speaker(s): D. Furie**

11. Audience to Visitors

**Speaker(s): D. Furie**

12. Adjournment

**Speaker(s): D. Furie**

**WINDSOR BOARD OF EDUCATION**

**AGENDA ITEM**

**For Consideration by the Board of Education at the Meeting of:** February 21, 2024

**PREPARED BY:** Danielle Batchelder

**PRESENTED BY:** Danielle Batchelder,  
Director of Business Services & Human  
Resources

**ATTACHMENTS:** January 31, 2024 Financial Report

**SUBJECT:** Financial Report

---

**BACKGROUND:**

A report of operating expenditures is prepared monthly for the Board of Education. The report details monthly and year-to-date expenditures for each site within Windsor Public Schools.

**STATUS:**

The attached report is for the month of January 2024

There were no inter-site transfers during the month.

**RECOMMENDATION:**

No action is necessary. The report is for information only.

The Secretary of the Board of Education should include the following in the minutes of this Board of Education meeting:

Expenditures for January 31, 2024	\$ 7,721,322
Expenditures & Encumbrances through January 31, 2024	\$43,856,259

---

**Reviewed by:**                     

**Recommended by the Superintendent:**                     

**Agenda Item #**           4.a.

Windsor Public Schools  
Financial Report  
January 31, 2024

	2023-2024 Budget	Expenditures YTD 1/31/24	Encumbrance	Balance 6/30/2024	% Balance
<b><u>Instructional Services</u></b>					
Clover Street School	63,170	23,085	3,400	36,685	58%
John F. Kennedy School	84,950	40,705	2,474	41,771	49%
Oliver Ellsworth School	86,730	39,870	2,796	44,064	51%
Poquonock School	69,300	34,141	4,062	31,097	45%
Sage Park Middle School	210,935	79,286	15,248	116,401	55%
Windsor High School	380,644	131,462	34,622	214,560	56%
Windsor High School Interscholastic Sports	207,000	197,026	8,560	1,414	1%
Athletic Coaches	299,000	124,988	0	174,012	58%
WHS Career & Technical Education	59,745	25,824	17,925	15,996	27%
Continuing Education	70,400	58,312	4,689	7,399	11%
Instructional Mgt. & Curriculum Development	181,985	34,495	4,145	143,345	79%
Magnet School Tuition	1,660,600	1,749,554	0	(88,954)	-5%
Technology	1,773,660	1,249,684	111,795	412,181	23%
<b>Total Instructional Services</b>	<b>5,148,119</b>	<b>3,788,432</b>	<b>209,716</b>	<b>1,149,971</b>	<b>22%</b>

<b><u>Education Support Services</u></b>					
Pupil Personnel Services	410,350	223,808	11,521	175,021	43%
Special Education	97,200	35,795	7,542	53,863	55%
Special Education Tuition	6,779,140	3,062,683	34,645	3,681,812	54%
Policy & Planning	136,386	90,784	6,813	38,789	28%
Employee Personnel Services	148,400	141,910	3,747	2,743	2%
Financial Management	268,340	124,055	68,738	75,547	28%
Financial Services	38,500	35,833	270	2,397	6%
Pupil Transportation & Safety	3,289,198	1,177,796	0	2,111,402	64%
Special Education Transportation	2,519,650	1,404,354	218,562	896,734	36%
Physical Plant Services	2,486,800	1,413,153	651,719	421,928	17%
Major Maintenance	486,000	232,082	2,499	251,419	52%
L.P. Wilson Center	254,800	98,560	80,256	75,984	30%
Benefits	11,919,971	5,177,913	171,665	6,570,393	55%
Certified Salaries	34,319,520	18,636,320	0	15,683,200	46%
Non-Certified Salaries	10,449,816	5,965,678	0	4,484,138	43%
Regular Ed Tutor Salaries	362,737	133,784	0	228,953	63%
Special Ed Tutor Salaries	298,370	287,598	0	10,772	4%
Substitute Salaries	770,714	358,028	0	412,686	54%
***Treehouse Subsidy	0			0	
<b>Total Education Support Services</b>	<b>75,035,892</b>	<b>38,600,134</b>	<b>1,257,977</b>	<b>35,177,781</b>	<b>47%</b>

<b>Total All Sites</b>	<b>\$80,184,011</b>	<b>\$42,388,566</b>	<b>\$1,467,693</b>	<b>\$36,327,752</b>	<b>45%</b>
------------------------	---------------------	---------------------	--------------------	---------------------	------------

WINDSOR BOARD OF EDUCATION

AGENDA ITEM

For Consideration by the Board of Education at the Meeting of: February 21, 2024

PREPARED BY: Danielle Batchelder  
Director of Business Services  
& Human Resources

PRESENTED BY: Danielle Batchelder

ATTACHMENTS: Student Enrollment Report & Recap

SUBJECT: Student Enrollment as of February 1, 2024

BACKGROUND:

Attached are the enrollment figures as of February 1, 2024. Mrs. Batchelder will answer any questions.

STATUS:

In prior BOE enrollment reports, the enrollment report grouped all students into one category labeled "Outside Placement/Private Placement (SPED)". Beginning in September 2016, the Out Placement/Private Placement (SPED) line was separated into two categories:

1. *Out of District Placement-Special Education students*
2. *Private Placement Special Education students*

**Out of District - Special Education:** Those students who are placed at a Connecticut State Department of Education (CSDE) approved private special education program as recommended by a planning and placement team (PPT) as part of a student's individualized education program (IEP). Additionally, this category may include a family who moves into Windsor with a child who has a disability who has already been placed in a private special education program and/or children who are placed in Windsor foster home(s) by the Department of Children and Families (DCF) and are already enrolled in a private special education program.

**Private Placement - Special Education:** Those students who have been identified special education through the planning and placement team (PPT) process that have been parentally placed at a non-public school located in Windsor (i.e., St. Gabriel, Trinity Christian, Madina Academy, Praise Power & Prayer, etc.).

RECOMMENDATION:

Informational

Reviewed by: 

Recommended by the Superintendent: 

Agenda Item # 4.6.

**Windsor Public Schools  
Student Enrollment Report  
February 1, 2024**

**Enrollment in Windsor Public Schools**

Grades PreK - 5	1,485
Grades 6-8	713
Grades 9-12	1,145
<b>Total District Enrollment</b>	<b>3,343</b>

**Windsor Students not in District Schools**

Out of District Placements (SPED)	34
Private Schools (St.Gabriels, Trinity Christian, Medina Academy; Praise, Power&Prayer)	58
CREC Montessori Hartford	3
CREC Metropolitan Learning Center (MLC)	56
CREC Miscellaneous Magnet Schools	229
Hartford Host Magnet Schools	195
Miscellaneous Magnet Schools (LEARN, Goodwin College & Global Experience)	28
A.I. Prince Technical High School	18
Howard Cheney Technical High School	15
	<b>636</b>
<b>Total Students</b>	<b>3,979</b>

**Windsor Public Schools  
Student Enrollment Report  
February 1, 2024**

<b>GRADE</b>	<b>Poquonock School</b>	<b>Clover Street School</b>	<b>Oliver Ellsworth School</b>	<b>John F. Kennedy School</b>	<b>Total</b>
PreK	103		40		143
K	84		127		211
1	102		114		216
2	108		139		247
3		81		135	216
4		89		134	223
5		107		122	229
<b>Subtotal K-5</b>					<b>1,342</b>
<b>Total</b>	<b>397</b>	<b>277</b>	<b>420</b>	<b>391</b>	<b>1,485</b>

<b>GRADE</b>	<b>Sage Park Middle School</b>
6	231
7	236
8	246
<b>Total</b>	<b>713</b>

<b>GRADE</b>	<b>Windsor High School</b>
9	282
10	293
11	264
12	306
<b>Total</b>	<b>1,145</b>

<b>District Wide Enrollment</b>	<b>3,343</b>
---------------------------------	--------------

ENROLLMENT REPORT 2023-2024  
POQUONOCK SCHOOL

Room #	Teacher	Grade	Projected	1-Sept	1-Oct	1-Nov	1-Dec	1-Jan	1-Feb	1-Mar	1-Apr	1-May	1-Jun
		Kindergarten											
	23 B. Brown			13	15	14	14	14	14				
	2 R. Brown			14	14	14	14	14	14				
	24 Eskenazi			14	14	14	14	14	14				
	22 Roche			13	13	14	13	13	14				
	3 Scott			14	14	14	14	14	14				
	26 Scerra			14	14	14	13	13	14				
		<b>Total</b>	<b>81</b>	<b>82</b>	<b>84</b>	<b>82</b>	<b>82</b>	<b>82</b>	<b>84</b>	<b>0</b>	<b>0</b>	<b>0</b>	<b>0</b>
		Grade 1											
	1 Kowalski			20	20	20	20	20	21				
	12 Alzamora			19	19	19	20	20	20				
	15 McCann			19	19	19	20	20	20				
	16 Harrison			19	19	19	20	20	20				
	18 Velez			20	20	20	20	20	21				
		<b>Total</b>	<b>102</b>	<b>97</b>	<b>97</b>	<b>102</b>	<b>100</b>	<b>100</b>	<b>102</b>	<b>0</b>	<b>0</b>	<b>0</b>	<b>0</b>
		Grade 2											
	14 Achim			22	22	22	23	23	21				
	11 Delskey			22	21	21	21	21	21				
	8 Parker			23	23	23	22	22	22				
	4 Stoll			23	23	23	22	22	22				
	9 Tweeddale			22	22	22	22	22	22				
		<b>Total</b>	<b>100</b>	<b>112</b>	<b>111</b>	<b>110</b>	<b>110</b>	<b>110</b>	<b>108</b>	<b>0</b>	<b>0</b>	<b>0</b>	<b>0</b>
		PK Smart Start											
		Sped & Peer											
		<b>Total</b>	<b>70</b>	<b>64</b>	<b>38</b>	<b>102</b>	<b>103</b>	<b>103</b>	<b>103</b>	<b>0</b>	<b>0</b>	<b>0</b>	<b>0</b>
		<b>Poquonock Totals</b>	<b>353</b>	<b>0</b>	<b>393</b>	<b>394</b>	<b>395</b>	<b>395</b>	<b>397</b>	<b>0</b>	<b>0</b>	<b>0</b>	<b>0</b>

**ENROLLMENT REPORT 2023-2024  
OLIVER ELLSWORTH SCHOOL**

Room #	Teacher	Grade	Projected	1-Sept	1-Oct	1-Nov	1-Dec	1-Jan	1-Feb	1-Mar	1-Apr	1-May	1-Jun
		Kindergarten											
19	Allen			13	14	14	14	14	14				
20	Klescezeski			16	16	16	16	16	16				
21	Moreno			15	15	15	15	15	15				
22	Bishop			15	16	16	16	17	17				
23	Heacock			16	17	17	17	17	17				
24	Stevens			16	16	16	16	16	16				
25	Chapple			16	16	16	16	16	16				
26	Nash			16	16	16	16	16	16				
	<b>Total</b>		<b>130</b>	<b>123</b>	<b>126</b>	<b>125</b>	<b>126</b>	<b>127</b>	<b>127</b>	<b>0</b>	<b>0</b>	<b>0</b>	<b>0</b>
		Grade 1											
10	Strickland			17	18	17	18	18	18				
12	Butterick			16	16	16	16	16	16				
13	Fleury Barton			17	17	17	17	17	17				
14	Och			16	15	15	15	14	14				
15	Adamski			17	17	17	17	16	16				
16	Miller			17	17	17	17	17	17				
17	Cook			16	16	16	16	16	16				
	<b>Total</b>		<b>135</b>	<b>116</b>	<b>116</b>	<b>115</b>	<b>116</b>	<b>114</b>	<b>114</b>	<b>0</b>	<b>0</b>	<b>0</b>	<b>0</b>
		Grade 2											
1	Mayo			21	21	21	21	21	20				
2	Billington			19	19	19	18	19	19				
3	McDonald			22	21	21	21	21	21				
6	Verdone			20	20	20	21	21	21				
7	Gonzalez			19	19	19	18	18	19				
8	Ozenne			18	18	18	19	20	20				
11	Montesione			15	16	16	18	19	19				
	<b>Total</b>		<b>123</b>	<b>134</b>	<b>136</b>	<b>134</b>	<b>136</b>	<b>139</b>	<b>139</b>	<b>0</b>	<b>0</b>	<b>0</b>	<b>0</b>
	PK Smart Start												
	Sped & Peers			36	38	37	38	38	40				
	<b>Total</b>		<b>63</b>	<b>36</b>	<b>38</b>	<b>37</b>	<b>38</b>	<b>38</b>	<b>40</b>	<b>0</b>	<b>0</b>	<b>0</b>	<b>0</b>
	<b>Totals</b>		<b>451</b>	<b>409</b>	<b>416</b>	<b>411</b>	<b>416</b>	<b>418</b>	<b>420</b>	<b>0</b>	<b>0</b>	<b>0</b>	<b>0</b>

Oliver Ellsworth

**ENROLLMENT REPORT 2023-2024**  
**Clover Street School**

Room #	Teacher	Grade	Projected	1-Sept	1-Oct	1-Nov	1-Dec	1-Jan	1-Feb	1-Mar	1-Apr	1-May	1-Jun
<b>Grade 3</b>													
25	Darrell			18	18	18	18	18	20				
8	Voronchak			21	21	21	21	21	21				
27	Rivers			18	19	18	19	19	20				
8	Driscoll			20	20	20	20	21	20				
<b>Total</b>			<b>82</b>	<b>77</b>	<b>78</b>	<b>77</b>	<b>78</b>	<b>79</b>	<b>81</b>	<b>0</b>	<b>0</b>	<b>0</b>	<b>0</b>
<b>Grade 4</b>													
24	Comer			16	17	17	17	17	18				
18	Sumner			18	18	18	18	18	18				
16	Murray			17	17	17	17	17	17				
11	Sanchez			18	18	18	18	18	18				
26	Junious			18	18	18	18	18	18				
<b>Total</b>			<b>105</b>	<b>87</b>	<b>88</b>	<b>88</b>	<b>88</b>	<b>88</b>	<b>89</b>	<b>0</b>	<b>0</b>	<b>0</b>	<b>0</b>
<b>Grade 5</b>													
15	Grimes			18	16	18	16	16	17				
13	Steele			19	20	19	20	19	20				
17	Nowusch			17	16	16	16	16	15				
18	Michalic			18	18	18	18	18	18				
19	Williams			18	19	18	19	19	19				
12	Burnham			18	18	18	18	18	18				
<b>Total</b>			<b>90</b>	<b>108</b>	<b>107</b>	<b>107</b>	<b>107</b>	<b>106</b>	<b>107</b>	<b>0</b>	<b>0</b>	<b>0</b>	<b>0</b>
<b>Totals</b>	<b>Clover</b>		<b>277</b>	<b>0</b>	<b>272</b>	<b>272</b>	<b>273</b>	<b>273</b>	<b>277</b>	<b>0</b>	<b>0</b>	<b>0</b>	<b>0</b>

**ENROLLMENT REPORT 2023-2024  
JF KENNEDY SCHOOL**

Room #	Teacher	Grade	Projected	1-Sept	1-Oct	1-Nov	1-Dec	1-Jan	1-Feb	1-Mar	1-Apr	1-May	1-Jun
		<b>Grade 3</b>											
1	Stout			19	19	19	19	19	19				
2	Nguyen			19	19	19	19	19	18				
3	Lamoureux			19	19	19	20	19	19				
4	Filomeno			20	20	20	20	20	21				
5	May			19	19	19	19	20	20				
6	Schultz			18	19	19	19	19	19				
8	Estelle			20	19	19	19	19	19				
	<b>Total</b>		<b>130</b>	<b>134</b>	<b>134</b>	<b>134</b>	<b>135</b>	<b>135</b>	<b>135</b>	<b>0</b>	<b>0</b>	<b>0</b>	<b>0</b>
		<b>Grade 4</b>											
7	Gilligan			21	23	23	23	23	23				
9	Jones			23	23	23	23	23	23				
10	Bell			22	22	22	22	22	21				
12	Kasavage			22	20	20	20	22	21				
14	Feliciano			22	23	23	23	22	23				
16	DaCosta			22	22	22	22	22	23				
	<b>Total</b>		<b>120</b>	<b>132</b>	<b>133</b>	<b>133</b>	<b>133</b>	<b>134</b>	<b>134</b>	<b>0</b>	<b>0</b>	<b>0</b>	<b>0</b>
		<b>Grade 5</b>											
19	Johnson			19	20	20	20	20	21				
20	Carpenter			21	21	21	21	21	21				
24	Lam			20	20	20	20	20	20				
25	Mitchell			21	21	21	21	21	20				
27	Kingsley			19	19	19	19	19	19				
28	Everett			20	20	20	20	20	21				
	<b>Total</b>		<b>121</b>	<b>120</b>	<b>121</b>	<b>121</b>	<b>121</b>	<b>121</b>	<b>122</b>	<b>0</b>	<b>0</b>	<b>0</b>	<b>0</b>
	<b>Totals</b>		<b>371</b>	<b>0</b>	<b>386</b>	<b>388</b>	<b>389</b>	<b>390</b>	<b>391</b>	<b>0</b>	<b>0</b>	<b>0</b>	<b>0</b>
	<b>John F. Kennedy</b>												

**ENROLLMENT REPORT 2023-2024**  
**Sage Park Middle School**

	Projected	1-Sept	1-Oct	1-Nov	1-Dec	1-Jan	1-Feb	1-Mar	1-Apr	1-May	1-Jun
<b>Grade 6</b>											
House 1			114	115	115	116	117				
House 2			110	110	111	112	114				
<b>Total</b>	<b>210</b>		<b>224</b>	<b>225</b>	<b>226</b>	<b>228</b>	<b>231</b>	<b>0</b>	<b>0</b>	<b>0</b>	<b>0</b>
<b>Grade 7</b>											
House 3			132	121	121	119	119				
House 4			102	117	118	117	117				
<b>Total</b>	<b>228</b>		<b>234</b>	<b>238</b>	<b>239</b>	<b>236</b>	<b>236</b>	<b>0</b>	<b>0</b>	<b>0</b>	<b>0</b>
<b>Grade 8</b>											
House 5			121	122	122	123	124				
House 6			120	120	121	121	122				
<b>Total</b>	<b>261</b>		<b>241</b>	<b>242</b>	<b>243</b>	<b>244</b>	<b>246</b>	<b>0</b>	<b>0</b>	<b>0</b>	<b>0</b>
<b>Sage Park Totals</b>	<b>699</b>	<b>0</b>	<b>699</b>	<b>705</b>	<b>708</b>	<b>708</b>	<b>713</b>	<b>0</b>	<b>0</b>	<b>0</b>	<b>0</b>

**ENROLLMENT REPORT 2023-2024**

**Windsor High School**

	Projected	1-Sept	1-Oct	1-Nov	1-Dec	1-Jan	1-Feb	1-Mar	1-Apr	1-May	1-Jun
<b>Grade 9</b>	302		299	300	300	300	282				
<b>Grade 10</b>	283		291	291	289	292	293				
<b>Grade 11</b>	292		270	269	269	270	264				
<b>Grade 12</b>	270		286	283	285	283	306				
<b>Windsor High Total</b>	<b>1,147</b>	<b>1,138</b>	<b>1,146</b>	<b>1,143</b>	<b>1,143</b>	<b>1,145</b>	<b>1,145</b>	<b>0</b>	<b>0</b>	<b>0</b>	<b>0</b>

**WINDSOR BOARD OF EDUCATION  
AGENDA ITEM**

**For Consideration by the Board of Education at the Meeting of:** Wednesday, February 21, 2024

**Prepared By:** Patricia Patton

**Presented By:** Danielle Batchelder

**Attachments:** Cafeteria Operations – January 2024

**Subject:** Food Service Financial Report

---

**Background:** The Windsor School Food Service participates in the National School Lunch Program at each of our school facilities. We also participate in the National School Breakfast Program at our four elementary schools, Sage Park Middle School and Windsor High School. We operated our Summer Food Service Program at John Fitch Park and Sharshon Park during summer break serving lunch. We are complying with the Healthy Food Certification again this year to send a consistent message to our students in keeping with our wellness policies.

Our annual goal is to operate with a small reserve account to offset unanticipated needs and to increase participation from students and staff in all our programs.

A monthly financial report is presented to the Board of Education. This report includes sales and financial information for the current period.

**Status:** Financial Report for January

**Recommendation:** Informational Only

---

**Reviewed by:** WPB      **Recommended by the Superintendent:** TH/SB  
**Agenda Item #** 4.C.

**Windsor School Food Service  
Financial Statement  
January 2024**

<b>REVENUE</b>	<b>January 2024</b>	<b>7/1/23 - YTD</b>	<b>January 2023</b>	<b>7/1/22-YTD</b>
SALES	\$29,784.65	\$249,759.82	\$53,379.97	\$171,092.67
REIMBURSEMENTS - STATE		9,291.15		
Federal Reimbursement	122,449.96	644,132.31	126,318.71	903,326.06
CLOC		105,865.00	96,037.00	217,716.00
MISC. (Rebates & Grants)		132,008.97	122,506.75	253,344.52
8 CENTS Certification	3,179.92	16,020.08	2,972.56	
<b>REVENUE TOTALS</b>	<b>\$155,414.53</b>	<b>\$1,157,077.33</b>	<b>\$401,214.99</b>	<b>1,545,479.25</b>
Refund	\$38.50	\$2,819.60		
<b>Total Revenue</b>	<b>\$155,376.03</b>	<b>\$1,154,257.73</b>		
 <b>EXPENSES</b>				
WAGES	\$59,279.91	\$381,505.00	\$55,698.35	\$377,738.69
PAYROLL TAXES	4,534.91	29,424.01	4,498.90	29,134.98
BENEFITS	7,105.40	44,918.35	9,398.28	72,482.55
FOOD/MILK/ICE CREAM	134,771.91	689,946.20	109,448.85	587,658.05
PAPER	4,671.97	25,268.46	1,831.29	31,704.83
TRUCK	62.61	2,278.93	149.96	3,240.26
MISC. SUPPLIES(UNIFORMS/OFFICE	125.76	4,668.51	288.45	1,588.21
EQUIPMENT	50,380.28	187,390.39	47,950.95	92,292.59
SERVICES	40.00	1,571.10	70.00	1,431.56
<b>EXPENSE TOTALS</b>	<b>\$260,972.75</b>	<b>\$1,366,970.95</b>	<b>\$229,335.03</b>	<b>\$1,197,271.72</b>
 <b>NET INCOME</b>	 <b>-\$105,596.72</b>	 <b>-\$212,713.22</b>	 <b>\$171,879.96</b>	 <b>\$348,207.53</b>
<b>INVENTORY</b>	<b>\$20,213.21</b>			<b>\$29,784.15</b>
<b>OPENING BALANCE 7/1</b>	<b>\$1,995,808.62</b>			<b>\$1,836,198.52</b>
<b>COMPUTED OPERATING POSITION</b>		<b>\$1,803,308.61</b>		<b>\$2,214,190.20</b>

**WINDSOR BOARD OF EDUCATION  
AGENDA ITEM**

**For Consideration by the Board of Education at the Meeting of:** February 21, 2024

**Prepared By:** Katherine Zager

**Presented By:** Danielle Batchelder, Director of  
Business Services & Human  
Resources

**Attachments:** Human Resources Report

**Subject:** Human Resources Report for January 1, 2024 – January 31, 2024

---

**NEW HIRES/REAPPOINTMENTS**

<b>First Name</b>	<b>Last Name</b>	<b>Position</b>	<b>Location</b>
Dawn	Noonan	Special Education Teacher	Poquonock
Noved	Mclean	Speech Language Pathologist	Poquonock
Cindy	Moeller	English Teacher	Windsor High
Ketura	Braswell	Cafeteria Monitor	JFK
Jordan	Carroll	Cafeteria Monitor	O. Ellsworth
Chandler	Davis	P/T SE Tutor	Poquonock

**REASSIGNMENTS/TRANSFERS**

<b>First Name</b>	<b>Last Name</b>	<b>Position</b>	<b>Location</b>
Theresa	Lewis	Paraprofessional	Clover
Arunika	Gamlath	Cafeteria Monitor	JFK
Elizabeth	Abbot	FRC Leader	POQ+JFK
Nathaniel	Secor	Operations and Maintenance Supervisor	Districtwide
Walter	Crain	Long-Term Sub	Sage Park

**RESIGNATIONS/SEPARATIONS**

<b>First Name</b>	<b>Last Name</b>	<b>Position</b>	<b>Location</b>
Amy	Lamenz	Art Teacher	Clover
Caitlin	Bramucci	Challenge Resource Teacher	Clover
Alicia	Petrucci	Speech Language Pathologist	O. Ellsworth
Michael	Chirico	Special Education Teacher	Poquonock
Melody	Thomas	Paraprofessional	O. Ellsworth
Talissa	Colon	Treehouse Group Leader	Poquonock
Cheryl	Chagnon	Paraprofessional	Sage Park
Michaela	Ruffin	Paraprofessional	Sage Park
Hector	Cuevas	Custodian II	Windsor High
Eamon	Doolittle	Temp. Tech. Support	Districtwide

**Reviewed by:** \_\_\_\_\_



**Recommended by the Superintendent:** \_\_\_\_\_



**Agenda Item #** \_\_\_\_\_



**Windsor Board of Education**  
**Special Meeting/Public Forum with Finance Committee Immediately**  
**Following, Hybrid via Zoom and In-Person**  
**Unapproved Minutes**

Tuesday, February 6, 2024 6:00 PM  
L.P. Wilson Community Center, Board Room  
601 Matianuck Avenue  
Windsor, CT 06095

The following are the unapproved minutes of the Tuesday, February 6, 2024 Special Meeting/Public Forum with Finance Committee Immediately Following. Any additions or corrections will be made at a future meeting.

Ms. Jill Canter: Present  
Mr. David Furie: Present  
Mr. Jeremy Halek: Present  
Mr. Anthony King: Present  
Mr. Leonard Lockhart: Present  
Mr. James Madison: Present  
Mr. Paul Panos: Present  
Ms. Ayana Taylor: Present  
Mr. Nathan Wolliston: Absent

Mr. King attended the meeting virtually.

Mr. Nathan Wolliston: Present  
Mr. Wolliston arrived at 6:17 PM.

1. Call to Order, Pledge to the Flag and Moment of Silence

Mr. Furie called the public forum to order at 6:06 PM.

2. Public Forum

There were no speakers.

3. Adjournment

Move to adjourn the public forum at 6:12 PM. This motion, made by Mr. Paul Panos and seconded by Ms. Ayana Taylor, Passed.

Ms. Jill Canter: Yes, Mr. David Furie: Yes, Mr. Jeremy Halek: Yes, Mr. Anthony King: Yes, Mr. Leonard Lockhart: Yes, Mr. James Madison: Yes, Mr. Paul Panos: Yes, Ms. Ayana Taylor: Yes

Yes: 8, No: 0

The public forum adjourned at 6:12 PM.

4. A MEETING OF THE BOE FINANCE COMMITTEE WILL IMMEDIATELY FOLLOW THE ADJOURNMENT OF THE PUBLIC FORUM

5. Finance Committee Meeting

6. Call to Order, Pledge of Allegiance, Moment of Silence

Mr. Lockhart called the Finance Committee meeting to order at 6:12 PM with the Pledge to the Flag and a Moment of Silence. Also in attendance were Superintendent of Schools Dr. Terrell Hill, Director of Business Services and Human Resources Danielle Batchelder, Assistant Superintendent for Instructional Services Dr. Noha Abdel-Hady, Director of Pupil and Special Education Services Mary Cristofaro.

7. Audience to Visitors

There were no speakers.

8. Discussion of the 2024-2025 Budget Proposal

The board provided questions prior to the meeting. Ms. Batchelder answered each question.

Site 82, Physical Plant Services, was presented by Director of Business Services and Human Resources Danielle Batchelder and Physical Plant Manager Carlos Rosario.

Site 83, LP Wilson, was addressed by Director of Business Services and Human Resources Danielle Batchelder and Physical Plant Manager Carlos Rosario.

Site 90, Salaries, was presented by Director of Business Services and Human Resources Danielle Batchelder.

Site 91, Employee Benefits, was presented by Director of Business Services and Human Resources Danielle Batchelder.

The Appendices were discussed.

The remaining questions, from prior meetings, were answered.

There will be no additional Finance Committee meeting on Tuesday, February 13, 2024.

The board members thanked Dr. Hill and his staff for their work. Each board member was given the opportunity to speak about the proposed budget.

The budget was turned over to the board at 8:50 PM.

The budget will be added to the Wednesday, February 21, 2024 Regular Meeting agenda.

9. Adjournment

Move to adjourn at 8:53 PM. This motion, made by Mr. Paul Panos and seconded by Ms. Ayana Taylor, Passed.

Ms. Jill Canter: Yes, Mr. David Furie: Yes, Mr. Jeremy Halek: Yes, Mr. Anthony King: Yes, Mr. Leonard Lockhart: Yes, Mr. James Madison: Yes, Mr. Paul Panos: Yes, Ms. Ayana Taylor: Yes, Mr. Nathan Wolliston: Yes

Yes: 9, No: 0

The meeting adjourned at 8:53 PM.

**Windsor Board of Education**  
**Finance Committee with Public Forum, Hybrid via Zoom and In-Person**  
**Unapproved Minutes**

Tuesday, January 23, 2024 6:00 PM  
L.P. Wilson Community Center, Board Room  
601 Matianuck Avenue  
Windsor, CT 06095

The following are the unapproved minutes of the Tuesday, January 23, 2024 Finance Committee with Public Forum. Any additions or corrections will be made at a future meeting.

Ms. Jill Canter:	Present
Mr. David Furie:	Present
Mr. Jeremy Halek:	Absent
Mr. Anthony King:	Present
Mr. Leonard Lockhart:	Present
Mr. James Madison:	Present
Mr. Paul Panos:	Present
Ms. Ayana Taylor:	Present
Mr. Nathan Wolliston:	Absent

Mr. Halek arrived at 6:12 PM and participated virtually. Mr. Wolliston arrived to the board room at 6:28 PM.

1. Call to Order, Pledge to the Flag and Moment of Silence

Mr. Furie called the public forum to order with a Pledge to the Flag and a Moment of Silence.

2. Public Forum

There were no speakers in the public forum.

3. Adjournment

Move to adjourn the public forum at 6:11 PM. This motion, made by Ms. Ayana Taylor and seconded by Mr. Paul Panos, Passed.

Ms. Jill Canter: Yes, Mr. David Furie: Yes, Mr. Anthony King: Yes, Mr. Leonard Lockhart: Yes, Mr. James Madison: Yes, Mr. Paul Panos: Yes, Ms. Ayana Taylor: Yes

Yes: 7, No: 0

The public forum adjourned at 6:11 PM.

4. A MEETING OF THE BOE FINANCE COMMITTEE WILL IMMEDIATELY FOLLOW THE ADJOURNMENT OF THE PUBLIC FORUM

5. Finance Committee Meeting

6. Call to Order, Pledge of Allegiance, Moment of Silence

Mr. Lockhart called the finance committee meeting to order at 6:12 PM with the Pledge to the Flag and a Moment of Silence. Also in attendance were Superintendent of Schools Dr. Terrell Hill, Director of Business Services and Human Resources Danielle Batchelder, Assistant Superintendent for Instructional Services Dr. Noha Abdel-Hady, Director of Pupil and Special Education Services Mary Cristofaro.

7. Audience to Visitors

There were no speakers.

8. Discussion of the 2024-2025 Budget Proposal

Dr. Hill deferred to Ms. Batchelder to review the questions presented by Mr. Panos prior to the meeting.

Mr. Wolliston arrived at 6:28 PM, prior to the site presentations.

Principal Mihalko and Principal Gruber presented Poquonock School and Oliver Ellsworth School.

Principal Gagne and Principal Lee presented John F. Kennedy School and Clover Street School.

Principal Jorgensen presented Sage Park Middle School, Site 53.

Principal Parker presented Windsor High School, Site 61.

Assistant Principal Fangiullo presented CTE (Career and Technical Education), Site 63.

Athletic Director Fulton presented the Athletic Department, Site 62.

Each site was asked if they had appropriate staffing and funds for educational materials.

The introductory pages will be addressed at a future meeting.

9. Adjournment

Move to adjourn at 9:01 PM. This motion, made by Mr. Nathan Wolliston and seconded by Mr. Paul Panos, Passed.

Ms. Jill Canter: Yes, Mr. David Furie: Yes, Mr. Jeremy Halek: Yes, Mr. Anthony King: Yes, Mr. Leonard Lockhart: Yes, Mr. James Madison: Yes, Mr. Paul Panos: Yes, Ms. Ayana Taylor: Yes, Mr. Nathan Wolliston: Yes

Yes: 9, No: 0

The meeting adjourned at 9:01 PM.

---

Leonard O. Lockhart, Secretary  
Windsor Board of Education

**Windsor Board of Education**  
**Special Meeting/Public Forum with Finance Committee Immediately Following,**  
**Hybrid via Zoom and In-Person**  
**Unapproved Minutes**  
Tuesday, January 30, 2024 6:00 PM  
L.P. Wilson Community Center, Board Room  
601 Matianuck Avenue  
Windsor, CT 06095

The following are the unapproved minutes of the Tuesday, January 30, 2024 Special Meeting/Public Forum with Finance Committee Immediately Following. Any additions or corrections will be made at a future meeting.

Ms. Jill Canter: Present  
Mr. David Furie: Present  
Mr. Jeremy Halek: Present  
Mr. Anthony King: Absent  
Mr. Leonard Lockhart: Present  
Mr. James Madison: Present  
Mr. Paul Panos: Present  
Ms. Ayana Taylor: Present  
Mr. Nathan Wolliston: Present

Ms. Taylor attended virtually.

Mr. Anthony King: Present

Mr. King arrived at 6:09 PM.

Ms. Ayana Taylor: Absent

Ms. Taylor left the meeting at 6:52 PM and did not return.

1. Call to Order, Pledge to the Flag and Moment of Silence

Mr. Furie called the public forum to order at 6:06 PM.

Move to amend the paper agenda to the correct date of January 30, 2024. This motion, made by Mr. Leonard Lockhart and seconded by Mr. Paul Panos, Passed.

Ms. Jill Canter: Yes, Mr. David Furie: Yes, Mr. Jeremy Halek: Yes, Mr. Leonard Lockhart: Yes, Mr. James Madison: Yes, Mr. Paul Panos: Yes, Ms. Ayana Taylor: Yes, Mr. Nathan Wolliston: Yes

Yes: 8, No: 0

2. Public Forum

Staff member Julii DeNegris, 26 Circle Drive, Enfield - She spoke in favor of continuing the ESSER funded nurse position with general funds from this budget.

3. Adjournment

Move to adjourn the public forum at 6:16 PM. This motion, made by Mr. Leonard Lockhart and seconded by Mr. Paul Panos, Passed.

Ms. Jill Canter: Yes, Mr. David Furie: Yes, Mr. Jeremy Halek: Yes, Mr. Anthony King: Yes, Mr. Leonard Lockhart: Yes, Mr. James Madison: Yes, Mr. Paul Panos: Yes, Ms. Ayana Taylor: Yes, Mr. Nathan Wolliston: Yes

Yes: 9, No: 0

The public forum adjourned at 6:16 PM.

4. A MEETING OF THE BOE FINANCE COMMITTEE WILL IMMEDIATELY FOLLOW THE ADJOURNMENT OF THE PUBLIC FORUM

5. Finance Committee Meeting

6. Call to Order, Pledge of Allegiance, Moment of Silence

Mr. Lockhart called the finance committee meeting to order at 6:16 PM with the Pledge to the Flag and a Moment of Silence. Also in attendance were Superintendent of Schools Dr. Terrell Hill, Director of Business Services and Human Resources Danielle Batchelder, Assistant Superintendent for Instructional Services Dr. Noha Abdel-Hady, Director of Pupil and Special Education Services Mary Cristofaro.

7. Audience to Visitors

There were no speakers for audience to visitors.

8. Discussion of the 2024-2025 Budget Proposal

The Introductory Pages were reviewed by Director of Business Services and Human Resources Danielle Batchelder.

Site 71, Continuing Education, was presented by Adult Education Coordinator Mayela Aguirre.

Site 41 was presented by Assistant Superintendent for Instructional Services Dr. Noha Abdel-Hady, Secondary Curriculum Director Bonnie Fineman, and Elementary Curriculum Director Michelle Williams.

Site 76, Technology, was presented by Assistant Superintendent for Instructional Services Dr. Noha Abdel-Hady.

Site 73, Pupil Personnel Services and Site 74, Special Education Services were presented by Director of Pupil and Special Education Services Mary Cristofaro, Intermediate SPED Supervisor Chris Bailey, Elementary SPED Supervisor Karen Lawson, Secondary SPED Supervisor Lindsay Jardine, and Nursing Supervisor Julii DeNegris.

Site 40, District Policy and Planning, was presented by Superintendent Dr. Terrell Hill.

Site 44, Employee Personnel Services, was presented by Director of Business Services and Human Resources Danielle Batchelder.

Sites 77 and 79, Fiscal Management and Fiscal Services, and Site 80, Transportation, were presented by Director of Business Services and Human Resources Danielle Batchelder.

Questions provided prior to the January 23 and tonight's finance committee meeting were addressed during and at the end of the site discussions.

Mr. Lockhart requested that questions should be provided to the administration, by the board be submitted no later than noon on the Monday before the meeting.

9. Adjournment

Move to adjourn at 8:35 PM. This motion, made by Mr. Paul Panos and seconded by Mr. David Furie, Passed.

Ms. Jill Canter: Yes, Mr. David Furie: Yes, Mr. Jeremy Halek: Yes, Mr. Anthony King: Yes, Mr. Leonard Lockhart: Yes, Mr. James Madison: Yes, Mr. Paul Panos: Yes, Mr. Nathan Wolliston: Yes

Yes: 8, No: 0

The Finance Committee Meeting adjourned at 8:35 PM.

**Windsor Board of Education**  
**Special Meeting/Public Forum with Finance Committee Immediately**  
**Following, Hybrid via Zoom and In-Person**  
**Unapproved Minutes**

Tuesday, February 6, 2024 6:00 PM  
L.P. Wilson Community Center, Board Room  
601 Matianuck Avenue  
Windsor, CT 06095

The following are the unapproved minutes of the Tuesday, February 6, 2024 Special Meeting/Public Forum with Finance Committee Immediately Following. Any additions or corrections will be made at a future meeting.

Ms. Jill Canter: Present  
Mr. David Furie: Present  
Mr. Jeremy Halek: Present  
Mr. Anthony King: Present  
Mr. Leonard Lockhart: Present  
Mr. James Madison: Present  
Mr. Paul Panos: Present  
Ms. Ayana Taylor: Present  
Mr. Nathan Wolliston: Absent  
Mr. King attended the meeting virtually.

Mr. Nathan Wolliston: Present  
Mr. Wolliston arrived at 6:17 PM.

1. Call to Order, Pledge to the Flag and Moment of Silence

Mr. Furie called the public forum to order at 6:06 PM.

2. Public Forum

There were no speakers.

3. Adjournment

Move to adjourn the public forum at 6:12 PM. This motion, made by Mr. Paul Panos and seconded by Ms. Ayana Taylor, Passed.

Ms. Jill Canter: Yes, Mr. David Furie: Yes, Mr. Jeremy Halek: Yes, Mr. Anthony King: Yes, Mr. Leonard Lockhart: Yes, Mr. James Madison: Yes, Mr. Paul Panos: Yes, Ms. Ayana Taylor: Yes

Yes: 8, No: 0

The public forum adjourned at 6:12 PM.

4. A MEETING OF THE BOE FINANCE COMMITTEE WILL IMMEDIATELY FOLLOW THE ADJOURNMENT OF THE PUBLIC FORUM

5. Finance Committee Meeting

6. Call to Order, Pledge of Allegiance, Moment of Silence

Mr. Lockhart called the Finance Committee meeting to order at 6:12 PM with the Pledge to the Flag and a Moment of Silence. Also in attendance were Superintendent of Schools Dr. Terrell Hill, Director of Business Services and Human Resources Danielle Batchelder, Assistant Superintendent for Instructional Services Dr. Noha Abdel-Hady, Director of Pupil and Special Education Services Mary Cristofaro.

7. Audience to Visitors

There were no speakers.

8. Discussion of the 2024-2025 Budget Proposal

The board provided questions prior to the meeting. Ms. Batchelder answered each question.

Site 82, Physical Plant Services, was presented by Director of Business Services and Human Resources Danielle Batchelder and Physical Plant Manager Carlos Rosario.

Site 83, LP Wilson, was addressed by Director of Business Services and Human Resources Danielle Batchelder and Physical Plant Manager Carlos Rosario.

Site 90, Salaries, was presented by Director of Business Services and Human Resources Danielle Batchelder.

Site 91, Employee Benefits, was presented by Director of Business Services and Human Resources Danielle Batchelder.

The Appendices were discussed.

The remaining questions, from prior meetings, were answered.

There will be no additional Finance Committee meeting on Tuesday, February 13, 2024.

The board members thanked Dr. Hill and his staff for their work. Each board member was given the opportunity to speak about the proposed budget.

The budget was turned over to the board at 8:50 PM.

The budget will be added to the Wednesday, February 21, 2024 Regular Meeting agenda.

9. Adjournment

Move to adjourn at 8:53 PM. This motion, made by Mr. Paul Panos and seconded by Ms. Ayana Taylor, Passed.

Ms. Jill Canter: Yes, Mr. David Furie: Yes, Mr. Jeremy Halek: Yes, Mr. Anthony King: Yes, Mr. Leonard Lockhart: Yes, Mr. James Madison: Yes, Mr. Paul Panos: Yes, Ms. Ayana Taylor: Yes, Mr. Nathan Wolliston: Yes

Yes: 9, No: 0

The meeting adjourned at 8:53 PM.

**WINDSOR BOARD OF EDUCATION**

**AGENDA ITEM**

**For Consideration by the Board of Education at the Meeting of:** February 21, 2024

**PREPARED BY:** Danielle Batchelder  
Director of Business Services  
& Human Resources

**PRESENTED BY:** Danielle Batchelder

**ATTACHMENTS:** Oliver Ellsworth School – HVAC System/Humidity Study

**SUBJECT:** Design Plan for Oliver Ellsworth Humidity Mitigation

---

**BACKGROUND:**

High humidity and mold have always been a concern and sporadic issue. In recent years the humidity/mold problems have increased, most likely due to increased rainfall and outdoor relative humidity. In 2022, Eagle Environmental was hired to perform a mold and moisture assessment of the school. Mold was found in a variety of spaces.

**STATUS:**

High humidity and the resulting mold growth can happen for a variety of reasons including lack of proper dehumidification, outdoor air infiltration, poorly sealed walls and windows, cooling coil condensate, piping condensation and lack of internal gains during unoccupied periods. In buildings that have slab on grade construction, water can seep or wick up through the cement floor, causing mold to grow on carpet pads or carpet backing. The condensate drains have recently been sealed for all unit ventilators. Piping condensation issues have been taken care of by the recent replacement of insulation on some sections of piping.

For this building we see the main source of high humidity as infiltration due to negative pressure and lack of internal gains during un-occupied or semi-occupied periods. Infiltration has been a known issue due to negative pressure in the space, which can be witnessed by opening any outside door. Negative pressure is caused by an imbalance between exhaust air and corresponding make-up air by the existing HVAC systems. There has been a temporary fix for this issue by disabling the exhaust fans that serve the spaces. The current arrangement of the classrooms requires a negative pressure in the classroom to facilitate bringing in fresh air through the unit ventilators. Most of the unit ventilators get their fresh air from a duct that contains an internal lining. Fresh air ductwork and duct lining are contributing to negative pressure issues due to static pressure drop. The lining also presents a problem from a mold growth standpoint, as it is directly exposed to humid outdoor air conditions. Finally, the unit ventilator intake louver is just inches above the roof and in close proximity to the roof drains, which can cause wetting of the intake duct during snow or rain conditions.

**RECOMMENDATION:**

Informational

---

**Reviewed by:** 

**Recommended by the Superintendent:** 





# Oliver Ellsworth Elementary School

## HVAC System / Humidity Study

DRAFT  
November 14, 2023

vZ #2023127.00

VAN ZELM HEYWOOD & SHADFORD, INC.

1200 CONVERSE STREET  
LONGMEADOW, MA 01106  
P: 617 218 9976

10 TALCOTT NOTCH  
FARMINGTON, CT 06032  
P: 860 274 5064  
[www.vanzelm.com](http://www.vanzelm.com)

862 BRAWLEY SCHOOL ROAD, SUITE 207  
MOORESVILLE, NC 28117  
P: 704-799-7275



**TABLE OF CONTENTS**

HUMIDITY / MOLD HISTORY .....2

HUMIDITY / MOLD PROBABLE CAUSES .....2

EXISTING CONDITIONS – HVAC SYSTEMS .....3

EXISTING CONDITIONS – ELECTRICAL SYSTEM.....4

RECOMMENDATIONS .....4

DOAS UNIT CONFIGURATION .....7

DOAS RECOMMENDATIONS .....9

PROPOSED ELECTRICAL SYSTEMS.....9

ORDER OF MAGNITUDE ESTIMATE OF PROBABLE COSTS.....10

SUMMARY .....11

**APPENDIX**

- A Photos
- B Heat Pipe Equipment Cutsheets
- C DOAS Units Equipment Cutsheets
- D Drawings



## **Oliver Ellsworth School**

### **HVAC System/Humidity Study**

#### **HUMIDITY / MOLD HISTORY**

According to the facilities technician that has maintained the building for 20+ years, high humidity and mold have always been a concern and sporadic issue. In recent years the humidity/mold problems have increased, most likely due to increased rainfall and outdoor relative humidity.

In 2022, Eagle Environmental was hired to perform a mold and moisture assessment of the school. Mold was found in a variety of spaces including classrooms and cafeteria. Other observations of mold include the intake/storage room at the gym and the storage room in the kitchen. Although no visible mold was found in the office areas, the main office sampling resulted in the highest spore concentration.

#### **HUMIDITY / MOLD PROBABLE CAUSES**

High humidity and the resulting mold growth can happen for a variety of reasons including lack of proper dehumidification, outdoor air infiltration, poorly sealed walls and windows, cooling coil condensate, piping condensation and lack of internal gains during unoccupied periods. In buildings that have slab on grade construction, water can seep or wick up through the cement floor, causing mold to grow on carpet pads or carpet backing. The condensate drains have recently been sealed for all unit ventilators. Piping condensation issues have been taken care of by the recent replacement of insulation on some sections of piping.

Enviro-Med, a testing firm, is currently evaluating the floor slab moisture and we are waiting for the final results. For this building we see the main source of high humidity as infiltration due to negative pressure and lack of internal gains during un-occupied or semi-occupied periods.

Infiltration has been a known issue due to negative pressure in the space, which can be witnessed by opening any outside door. Negative pressure is caused by an imbalance between exhaust air and corresponding make-up air by the existing HVAC systems. There has been a temporary fix for this issue by disabling the exhaust fans that serve the spaces. The current arrangement of the classrooms requires a negative pressure in the classroom to facilitate bringing in fresh air through the unit ventilators. Most of the unit ventilators get their fresh air from a duct that contains an internal lining. Fresh air ductwork and duct lining are contributing to negative pressure issues due to static pressure drop. The lining also presents a problem from a mold growth standpoint, as it is directly exposed to humid outdoor air conditions. Finally, the unit ventilator intake louver is just inches above the roof and in close proximity to the roof drains, which can cause wetting of the intake duct during snow or rain conditions.

Some windows in the school are single pane and significant condensation can be witnessed on the outside of the windows when it is humid outside. This condensation in conjunction with negative building air pressure may be contributing to the problem since the main path for infiltration is around the window casings.

The occupancy of schools tends to be very low in the summertime, and this results in the internal heat gains being very low. The reduced loads during unoccupied periods require the cooling systems to do less work which results in reduced dehumidification and higher humidity levels in the space. The formula of reduced cooling load with constant ventilation rates is problematic for humidity control.

During October 2023, sub slab moisture testing was performed by Enviro-Med. The report indicated higher than recommended relative humidity within the concrete slab floors in about 25 areas of the school. We believe the sub slab moisture is not the main source of mold in the building, however. There are recommendations in the report, such as replacing the gym floor within the next 5 years and fixing any site drainage issues, which the Town should consider.

**Envelope Testing**

During October and November 2023, Gale Associates performed a review of the envelope with infra-red and blower door testing. Our review of their report indicates that the envelope quality is not the primary source of the mold problem, however.

**EXISTING CONDITIONS – HVAC SYSTEMS**

The building’s heating and cooling plant consists of a 225-ton Carrier 23 XRV screw chiller, three Aerco Benchmark 2,000 mbh condensing boilers, and a 675 GPM BAC cooling tower mounted on grade. The piping system is 2-pipe with variable speed pumps. The plant equipment and piping was installed in 2018.

Classrooms are heated, cooled, and ventilated with unit ventilators that are fed by the 2-pipe chilled water/hot water system. Many of the unit ventilator’s fresh air intakes are via lined ductwork that is routed within wall cavity to louvers at roof level. The unit ventilators (1500 cfm) are equipped with economizer controls for free cooling. Constant volume roof mounted exhaust fans (525 cfm per classroom) provide exhaust air to the classrooms. Corridors and miscellaneous spaces are served by 2-pipe fan coil units and hot water fin tube radiation. All unit ventilators and fan coil units were replaced in 2018.

The Gymnasium, Cafeteria, and Kitchen are served by air handlers located in a mezzanine mechanical room. The air handlers are equipped with 2-pipe heating/cooling coils and separate exhaust fans. The units are sized for 0-100% O.A. but the control sequence is unknown. The controls for these AHUs are using older Honeywell Spyder controllers with no outputs or trending for analysis.

The kitchen contains an exhaust hood with make-up air provided by air handling unit AHU-6.

The Office area is served by a DX rooftop unit with VAV zone control. The return duct is located under the floor slab.

**EXISTING CONDITIONS – ELECTRICAL SYSTEM**

The main electrical service was installed in 1968 and includes a utility-owned 750 kVA (actual size is pending confirmation) 13.2kV – 480/277, 3 phase, 4W pad-mounted transformer and a 1200A, 480/277V, 3-phase, 4W main service switchboard manufacturer by GE. This service provides power for the entire building. The existing GE switchboard comprises two sections. The main section houses a 1200A main circuit breaker. The second section serve as the distribution section. This section houses ten (10) feeder circuit breakers. The switchboard is located in the Main Electrical room

The electrical system also includes 480V-208/120V, 3 phase, dry type transformers. There are several electrical panels located throughout the facility, which are original to the building. There does not appear to be any spare circuit breakers available to add any electrical circuits. The condition of the panelboards is poor. The original panelboards are manufactured by GE.

**RECOMMENDATIONS**

**Classrooms**

To alleviate the negative pressure and corresponding high humidity issues in the classrooms, we recommend capping the fresh air duct to the unit ventilators and providing new dedicated outside air supply (DOAS) air handling units located on the roof or on grade. These units can provide cooling and dehumidification through the use of direct expansion refrigerant (DX) or chilled water coils, but must provide some form of reheat for true dehumidification control or the spaces may over-cool. DOAS units bring in 100% outside air in quantities required for proper ventilation (based on Code), delivering it directly to the occupied areas, and provide balanced exhaust to eliminate negative pressure in the building. A heat recovery device (heat wheel) is utilized to transfer energy between the two airstreams, preheating in the winter and precooling/dehumidifying in the summer. DOAS units will solve both the infiltration problem due to negative pressure and the lack of internal gains during unoccupied periods, while saving energy and operating costs. The capping of the fresh air duct will eliminate the economizer cycle, but the DOAS units may be used during the shoulder periods to cool the classrooms in lieu of the unit ventilators.

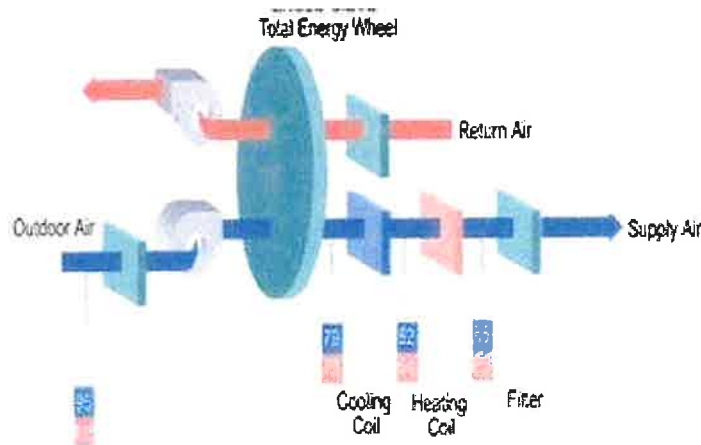

## Gymnasium

The Gymnasium air handling unit and associated exhaust fan are currently outfitted with variable frequency drives (VFDs) for volume control. The control of this unit shall be updated to operate under a single zone VAV sequence. A carbon dioxide (CO<sub>2</sub>) sensor shall be added to the space or return ductwork and a demand control ventilation sequence of operation added to the control system. This will closely match the quantity of outside air provided to the occupancy of the space. The return/exhaust air for the gym is transferred back to the unit through louver doors in the storage room. The grille situation should be improved if possible by ducting return air directly to the Gymnasium.

**Option 1:** Provide new hot water reheat coil in the existing air handling unit. This option requires a new hot water piping loop and modifications to the existing condensing boiler plant to allow it to operate year-round, and will increase energy use/cost.

**Option 2 (recommended):** Provide a new DOAS roof mounted air handling unit with chilled water cooling to satisfy only the gym's outdoor air requirements during normal occupancy. Unit shall be located on lower roof and connect into AHU-4 return duct. AHU-4 control sequence shall be revised to operate in sequence with the new DOAS unit.

## Locker Rooms

The boy's locker room has been converted to storage. The girl's locker room status is unknown. Both locker room air handling units are located in the mezzanine mechanical room, are in poor condition, and are in need of replacement. Locker rooms have significant outside air and exhaust requirements. If the spaces are to be used as locker rooms a heat recovery unit is both recommended and required by Code.

**Option 1:** Provide new indoor air handling units to match existing and update controls to the building standard system (Distech). This option is valid only if not used as locker room program space.

**Option 2 (recommended):** Provide one new roof mounted DOAS unit to serve both locker rooms.

**Option 3:** Provide two new ERV indoor units with chilled water coil. Space constraints may be an issue for this option. This option would allow for better zoning, and recirculation damper could be added to satisfy the current space use and minimize energy cost.

## Cafeteria

For the existing system, the control sequence should be reviewed and updated. Field observations during site visit showed the supply fan VFD at 33% and the exhaust fan VFD at 100%, indicating a negative pressure condition. Adding transfer grilles between kitchen and cafeteria will help reduce the negative pressure in the building. The existing cafeteria exhaust fan can be modulated to maintain positive pressure in the cafeteria which will allow for changes in kitchen exhaust and fresh air being supplied to the cafeteria. A demand control ventilation sequence of operation should be added to the DDC control system to minimize fresh air introduced to the space.

**Option 1:** Provide new hot water reheat coil. This option requires a new hot water piping loop and modification to the existing condensing boiler plant to allow it to operate year-round, increasing energy cost..

**Option 2 (recommended):** Install a heat pipe type heat recovery unit between return and supply duct for reheat. This option will save significant energy.

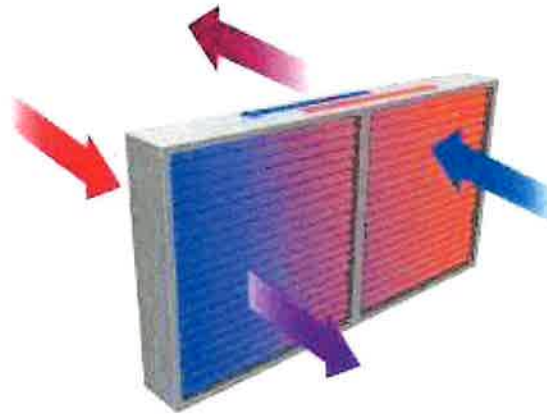

### **Storage Room**

This room was originally a dishwasher room that required significant exhaust (2,000 cfm) and supply (1,600 cfm). The room is now a storage room and should be re-balanced to code-required fresh air flow (25 cfm). The fresh air currently being supplied to the storage room can be redirected to the cafeteria which will contribute to the kitchen make-up.

### **Stage**

The stage area is walled off and currently used as a music room. The return air path needs to be reviewed more closely to ensure proper airflow is provided to the space.

### **Kitchen**

An air balancing firm shall run tests with kitchen hood on after the completion of this project. Test should include AHU supply CFM, return CFM, exhaust CFM, Kitchen hood exhaust CFM, and space pressure. The system should then be properly balanced.

### **Kitchen Storage**

The kitchen storage room contains just one exhaust which is drawing in moist kitchen air and creating mold problems. A supply duct should be added to the storage room to keep the space under positive pressure. The exhaust rate also seems to exceed code requirements, so the fan airflow should be rebalanced.

## Offices

The office area high spore concentration should be addressed after further testing is completed. It is possible that the source of the mold growth is coming from the under-slab return duct system. The sub-slab moisture testing indicated elevated moisture levels in the office area.

**Option 1:** Eliminate the under-slab duct and replace it with ceiling return duct system if space allows. This option requires further investigation.

**Option 2:** Install a Rawal APR control valve in the packaged DX rooftop unit for better capacity control, resulting in a more consistent humidity control. Additionally, upgrade unit to demand control ventilation if possible.

**Option 3 (recommended):** Replace existing 5 ton Trane unit with a similar DX rooftop that has hot gas reheat capability and CO2-based demand control ventilation.

## Controls

The Gym, Cafeteria, and Kitchen are controlled by an older DDC system that may lack expandability. These unit controls should be updated to Distech, and demand control ventilation should be added. The control sequences for the existing unit ventilators will be revised for recirculation while heating and cooling. The unit ventilator economizer sequence will be disabled. The new DOAS units will require an expansion of the existing Distech controls. Normally, the DOAS units would be equipped with on-board controls, but the use of the chilled water coil for cooling and heating may require field-mounted Distech control. Control requirements may differ depending on the chosen manufacturer of the unit.

## Adjusting and Balancing

Since the DOAS units will be reducing the load on the unit ventilators the fan speed may be reduced, resulting in a quieter air delivery. This project will require a building-wide complete air balance of all diffusers, registers, fans, coils and dampers.

## Structural Modification

We have reviewed the option of installing roof-mounted DOAS units with a structural engineer, Girard Associates, in order to determine the extent of structural reinforcement required. Based on the DOAS unit sizes and weights, their review indicated that no major structural modifications would be required, only modest reinforcements.

## DOAS UNIT CONFIGURATION

DOAS units are available with myriad options including heat pumps, chilled water coils, hot water reheat, Energy Recovery (ERV) wheels and plates, gas primary heat, gas reheat, electric reheat, hot gas bypass, etc. The goal of our unit selection is to select a product that will dehumidify under all conditions and be available for summer 2024 installation.

**Option A: DOAS Chilled Water/Gas**

Since chilled water is available on site, this is our preferred option from an energy standpoint. Using chilled water for primary cooling will also require reheat to satisfy humidity requirements during lightly loaded periods. If units are mounted on grade, the chilled water unit option will require heat trace on the exposed piping. Available reheat options are natural gas and hot water.

**Option A1: DOAS Chilled Water/Hot Water**

The second choice for the DAS units would be chilled water with hot water reheat. The current lead time for a Valent VXE112 with chilled water cooling, hot water reheat and ERV is roughly 18 weeks (as of 10/24/23). Running a new hot water piping loop in the corridor ceiling may be a challenge due to existing conditions and the addition of chilled water piping required to support the new units. Distech may need to fully control this unit due to using the chilled water coil for cooling and heating. This option will carry a significantly higher first cost than Option A, since gas piping on the roof is more cost effective than hot water piping run in existing congested ceiling. Both Option A and Option A1 utilize the existing condensing boilers for pre-heat. Option A1 utilizes the condensing boilers for pre-heat and re-heat.

**Pros:**

- Will add load to a lightly loaded chiller, improving performance.
- Much lower electrical power usage than heat pump option.
- Unit is lighter than heat pump DOAS unit by approximately 900 lbs.
- Less maintenance than heat pump unit.
- Better discharge

**Cons:**

- Grade mounted units will require electric heat trace to prevent freezing.
- Requires piping to be installed in corridor ceiling.
- Using chilled water coil for heating may require field mounted controls.
- Required roof mounted gas piping or hot water piping in corridor.

**Option B: DOAS DX option**

The DOAS units with heat pumps are a good option to consider for dehumidification. The air source heat pump is utilized for heating and cooling while hot gas reheat is used when internal space gains are low. This option does require supplemental electric heat when outdoor temperatures are below 10°F. A hot water reheat coil would be preferred, but the unit configuration will not allow roof mounted ductwork if that option is chosen.

**Pros:**

- Hot gas bypass for reheat and heat pump for heating down to 10°F.
- No potential freezing issues.
- Onboard controls can be used with BACnet interface.
- Does not use natural gas for heat from an electrification standpoint.

**Cons:**

- More unit weight than chilled water unit, which may have structural implications.
- DX unit has higher first cost.
- Requires significantly more electrical power than chilled water unit, with associated electrical system upgrades.
- Increase in electrical usage and demand charges.
- This option reduces the load on the chiller plant which may be a problem due to limited turn-down of the already oversized chiller.
- Increased maintenance cost due to compressors in unit.

**DOAS RECOMMENDATIONS**

**DOAS recommendation Option A**

We recommend the chilled water DOAS unit configuration with natural gas for reheat. The only factor that would make us consider the DX heat pump unit is a difference in lead time, or if the units need to be mounted on grade due to structural implications. The current lead time for a Valent VXE112 with Chilled water cooling, natural gas reheat and ERV is roughly 18 weeks (as of 10/24/23). Structural support confirmation, final CFM of supply/exhaust, and unit voltage shall be confirmed prior to ordering unit. Distech may need to fully control this unit due to using the chilled water coil for cooling and heating.

**New unit zoning**

- DOAS-1 serves Classrooms 1,2,3,4,5,6,7,8, Teacher’s Lounge, Family center, Media center, Lobby (3,500 cfm)
- DOAS-2 serves Classrooms 12,13,16,17,21,22,25,26, (2) Special Ed classrooms, Corridors (3,100 cfm)
- DOAS-3 serves Classrooms 10,11,14,15,19,20,23,24, Corridors (2,500 cfm)
- DOAS-4 serves Classrooms 27,28,29,30, work room, Reading, Media Center, Corridor (2,500 cfm)
- DOAS-5 serves Gym unit AHU-4 minimum outside air (1600 cfm)
- DOAS-6 serves Boys and Girls Locker room (1300 cfm) – Unit will be used for ventilation, cooling and heating. Discharge air temperatures will be calculated for heating and cooling loads. Additional hot water coil added for Boys room due to skin load.

**PROPOSED ELECTRICAL SYSTEMS**

**DOAS Option A:** Six chilled water DOAS units with natural gas for reheat or hot water reheat.

Based on the analysis of the new electrical loads for the proposed mechanical equipment, it appears that the existing 1200A, 480/277V, 3-phase, 4W can accommodate the new recommended mechanical systems. No major upgrade to the electrical system is required.

We recommend adding a new 200A, 3P feeder circuit breaker in the existing distribution section located in the main electrical room to serve a new 200A, 3 phase, 480/277VAC, 65 kAIC power panel to be located in the Mezzanine room. This power panel will feed the six (6) new DOAS units located throughout the roof. A new 4#4/0, 1#4G, 2 1/2”C feeder from the switchboard to the new power panel location should be installed.

Each of the new DOAS roof units should be fed from a new 25A-3P circuit breaker located in the new power panel. Provided a new 3#10, 1#10G, 3/4" C feeder from the new panel to each unit.

A new waterproof 30A, 3P fused disconnect switch, with 20A fuses should be located adjacent to each DOAS unit.

**DOAS Option B:** Six DOAS heat pump units with electric heat (if the heat pump units with electric heat is chosen by the Mechanical trade)

Based on the analysis of the existing historical electric bill in the past 12-month period and the new electrical loads for the proposed mechanical equipment, it appears that the existing utility-owned 750 kVA pad-mounted transformer (actual size is pending confirmation) can accommodate the new recommended mechanical systems, but this needs to be reviewed further.

If the pad-mounted transformer has the spare capacity, we recommend the existing 1200A distribution section located in the Main Electrical room be replaced in its entirety with a new 1200A switchboard, arranged to accommodate a new 600A, 3P feeder circuit breaker, along with the existing to remain ten (10) feeder circuit breakers.

A new 600A, 3 phase, 480/277VAC, 65 kAIC power panel should be added in the Mezzanine room. This power panel will feed the six (6) new DOAS heat pump units located throughout the roof.

A new two sets of 4#350 KCM, 1#1G, 3" C feeder from the switchboard to the new power panel location should be installed.

Each of the new DOAS heat pump units should be fed from a new 100A-3P circuit breaker located in the new power panel. Provide a new 3#2, 1#8G, 1 1/2" C feeder from the new panel to each unit.

A new waterproof 100A, 3P fused disconnect switch, with 100A fuses should be located adjacent to each DOAS heat pump unit.

**ORDER OF MAGNITUDE ESTIMATE OF PROBABLE COSTS**

- This provides a rough estimate of the MEP construction costs involved with Option B (average case). Costs of the project will vary greatly based on material costs, labor, schedule, etc. Construction costs have been very volatile since 2020, and the after-effects of the COVID pandemic are still being felt.
- This project will have significant non-MEP scope including general construction, rigging, cutting and patching, ceiling work, etc. We strongly recommend retaining a construction manager for accurate pricing, scheduling and bidding work.
- This estimate includes hard construction costs only, and does not include "below the line" costs such as design fees, permits, contingencies, O&P, etc.

SCOPE	COST
DOAS Units	\$ 750,000
Ductwork	450,000
Heat Pipe ER Unit	80,000
Piping	395,000
Insulation	95,000
Controls	266,000
Pumps and Valves	85,000
Electrical	140,000
General Construction	375,000
Structural Work	78,000
<b>TOTAL</b>	<b>\$ 2,714,000</b>

**SUMMARY**

The new equipment and modifications to the building described in this report will drastically improve humidity control in the building. To expedite the installation of the systems, long lead time items need to be identified and pre-ordered.

Action items include the following for the next phase of project (Design Phase):

- Decision on unit configuration (Heat pump vs Chilled water).
- If heat pump type unit is selected, provide more detailed review of electrical distribution required to serve units. Overall, electrical service appears adequate.
- More detailed structural analysis.
- Scheduling of DOAS units for Pre-Purchase.
- Bid leveling if multiple unit manufacturers are considered.

**Miscellaneous Items Outside Scope**

The boiler room still has one atmospheric-type gas fired hot water heater that requires combustion air, but there are no combustion air louvers. Boiler room is very large so it most likely is operating adequately with infiltration to satisfy combustion air.

The chiller room does not have a refrigerant monitor or refrigerant exhaust fan & intake. With 802 lbs of 134a refrigerant, a 2,850 cfm exhaust fan with high/low grilles is required in addition to fresh air louver or penthouse (ASHRAE 15).

**Electrification**

When considering significant upgrades to a building’s HVAC system it is always a good idea to invest in equipment that will reduce carbon emissions if possible. The HVAC systems in the building were recently upgraded in 2018 and include high efficiency condensing boilers and a high efficiency chiller. Our recommended option in this report utilizes these existing components and also reduces energy use further due to added energy recovery on all outdoor air that is introduced in the classrooms.

The electrification option of using DOAS heat pump units with electric heat is a viable option to solve the high humidity issues but does come with some added direct and indirect costs. The electrical energy costs will go up for the school due to the combination of using the existing chiller and the heat pump during the cooling season. Part of this increased utility cost may also be due to increased electrical demand charge. If heat pumps are selected this will reduce thermal load on the chiller, which may require it to be replaced as part of this project.

If the Town desires to reduce substantial reduce carbon emissions, a more direct path would be to install a central air source heat pump to replace the chiller and also provide heating capacity while the gas fired boilers are used for backup. This major upgrade should be handled separately from the humidity mold project and will not alter our DOAS equipment recommendation.

-END-

u:\2023\2023127.00\study\hvac humidity study\oliver ellsworth school-hvac system study master.doc



## APPENDIX A

### Photos



**APPENDIX A**  
**Photos**



*Condensing boilers - recently replaced*



*Boiler & Chiller plant feeding 2-pipe system*



*Existing Cafeteria unit  
Where heat pipe will be installed*



*Boy's Locker Room unit  
(not functional)*



*Packaged rooftop unit serving Office area*



*Roof view*



*Lower roof where new DOA units will be placed*



*Typical fresh air louver serving Unit Ventilators*



*Typical Classroom showing Unit Ventilator*



*Ceiling cavity where new ductwork from DOAS units will be run*



*Ceiling space in Corridor area*



*Louvered door in Gym storage room*

APPENDIX B

Heat Pipe  
Equipment Cutsheets



## Project Submittal

Prepared For:	Jon Peterson	Prepared By:	Eric Cormier (ecormier) Flow Tech Inc.
Project:	Windsor Public Schools  Windsor Connecticut	Date:	10/25/2023 6:59 AM
		HPT Project:	223626

Qty:	Model:	Tag:	Order Code:
1	HRM	Cafeteria	HO-AMG-10812A-07125-04500-3200F-04500-XXM

The attached information describes the equipment we propose to furnish for this project and is submitted for your approval

**HRM Order Code**

EC150212  
Rev4 2/21/2019

Model	Materials	Coil Configuration	Geometry	Option
H H -	A M G -	1 01 08 A -	07625 - 12038 - 2038 X - 12038 -	E D X

Example order code used for demonstration only

**Custom Options**  
X - None, S - Unique option

**Damper**  
X - None, D - Damper

**Fin Coating**  
X - None, E - ECoat, H - Heresite P-413

**Exhaust Fin Length (for HRM-H and HRM-Z),  
Upper Face Height (for HRM-O)**  
XXX.XX in

**Gap Fill Material**  
X - None, F - Foam

**Gap Length**  
XX.XX in

**Supply Fin Length (for HRM-H and HRM-Z), Lower Face Height (for HRM-O)**  
XXX.XX in

**Fin Height (for HRM-H and HRM-Z), Face Length (for HRM-O)**  
XXX.XX in

**Pipe Diameter**  
A - 1/2"

**Fins Per Inch**  
10, 12, 14

**No. of Rows**  
01, 02, 03, 04, 05, 06, 07, 08

**No. of Stacked Sections**  
1 - 1 Section, 2 - 2 Sections, 3 - 3 Sections

**Sheet Metal**  
S - 304 Stainless Steel, G - G90 Galvanized

**Refrigerant**  
M - R410A, N - R134A

**Fin Material**  
A - Aluminum .006", C - Copper .005"

**Type**  
H - HRM-H Horizontal, A - HRM-Z Optimized For Heating, B - HRM-Z Optimized For Cooling, O - HRM-O Over-Under

**HRM**  
H - Heat Recovery

Qty:	Model:	Tag:	Order Code:
1	HRM	Cafeteria	HO-AMG-10812A-07125-04500-3200F-04500-XXM

### HRM Design Performance

Elevation: 0 ft.  
 Air Type: Standard

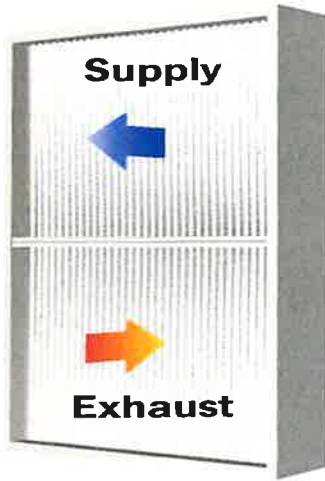

OACF 1.00	EATR % 0.0
11,500 SCFM	
55.00 °F DB	61.09 °F DB
45.11 °F WB	57.47 °F WB
45.0 %RH	80.7 %RH
↓	↑
Supply	Exhaust
↓	↑
64.34 °F DB	7,650 SCFM
49.44 °F WB	75.00 °F DB
32.2 %RH	62.54 °F WB
	50.0 %RH

SCFM1=SCFM2=Net Supply Airflow

### Coil Performance

Pressure Drop (in. H2O)	0.85	0.5
Face Velocity (SFPM)	516.50	343.60
Temperature Gain/Loss(°F)	9.30	13.90
Sensible Effectiveness %	70.2	
Latent Effectiveness %	0.0	
Total Effectiveness %	48.7	
Heat Transferred (BTU/h)	116,920	
Condensation (lbs/hr)	0.0	0

### Coil Design

Face Height (in.)	45.00	45.00
Face Length (in.)	71.25	71.25
Face Area (SF)	22.27	22.27
No. of Rows	8	8
Tube OD (in.)	1/2	1/2
Fins per inch	12	12
Fin Type	Standard	Standard
Fin Material	Aluminum	Aluminum
Tilt Angle degree	90	

Refrigerant: R410a

Application Rating is outside the scope of the AHRI ERV Certification Program but is rated in accordance with AHRI Standard 1060.

Performance is based on counterflow conditions.

Performance is single season based on airflow orientation

Final 2.1

Qty:	Model:	Tag:	Order Code:
1	HRM	Cafeteria	HO-AMG-10812A-07125-04500-3200F-04500-XXM

### HRM Bin Analysis

	<u>Supply</u>	<u>Exhaust</u>	Heat pipe installed as retrofit	
Airflow (CFM)	11,500	7,650	Cooling	Electric
Face Height (in.)	45.00	45.00	Heating	Electric
Face Length (in.)	71.25	71.25	Cooling EER	15
Face Area (SQFT)	22.27	22.27	Electric Rate	\$0.0800/kwh
Face Velocity (SFPM)	516.5	343.6		
Max Pressure Drop (in. H2O)	0.85	0.5	Burner Efficiency	75%
No. of Rows	8	8	Motor Efficiency	90%
Fins Per Inch	12	12	Fan Efficiency	70%
Fin Material	Aluminum	Aluminum	Evaporative Cooling	No
Fin Type	Standard	Standard	Refrigerant	R410a
Desired Leaving Temps.	-	36°F(min)	RER	0.00
			Rate of Return	NA

BRIDGEPORT SIKORSKY MEMORIAL, CT @M-F: 0-24 Sat: 0-24 Sun: 0-24, Months: All.

Outside Air (Supply Entering)			Supply Air Leaving	Exhaust Air Entering	Exhaust Air Leaving	Heat Pipe Heat Recovery		RunTime	Savings	Fan Cost	Net Savings
Heat Pipe CFM	DB Bin °F	MCWB °F	DB/WB °F/°F	DB/WB °F/°F	DB/WB °F/°F	Eff %	BTU/h	h/Year	\$/Year	\$/Year	\$/Year
<b>Totals:</b>									<b>\$0</b>	<b>\$0</b>	<b>\$0</b>

Performance is single season based on airflow orientation

Qty:	Model:	Tag:	Order Code:
1	HRM	Cafeteria	HO-AMG-10812A-07125-04500-3200F-04500-XXM

**Psychrometric Analysis**

Supply Airflow:	11500 CFM	Exhaust Airflow:	7650 CFM
Supply Entering:	55.0/45.1 °F DB/ °F WB	Exhaust Entering:	75.0/62.5 °F DB/ °F WB
Supply Leaving:	64.3/49.4 °F DB/ °F WB	Exhaust Leaving:	61.1/57.5 °F DB/ °F WB

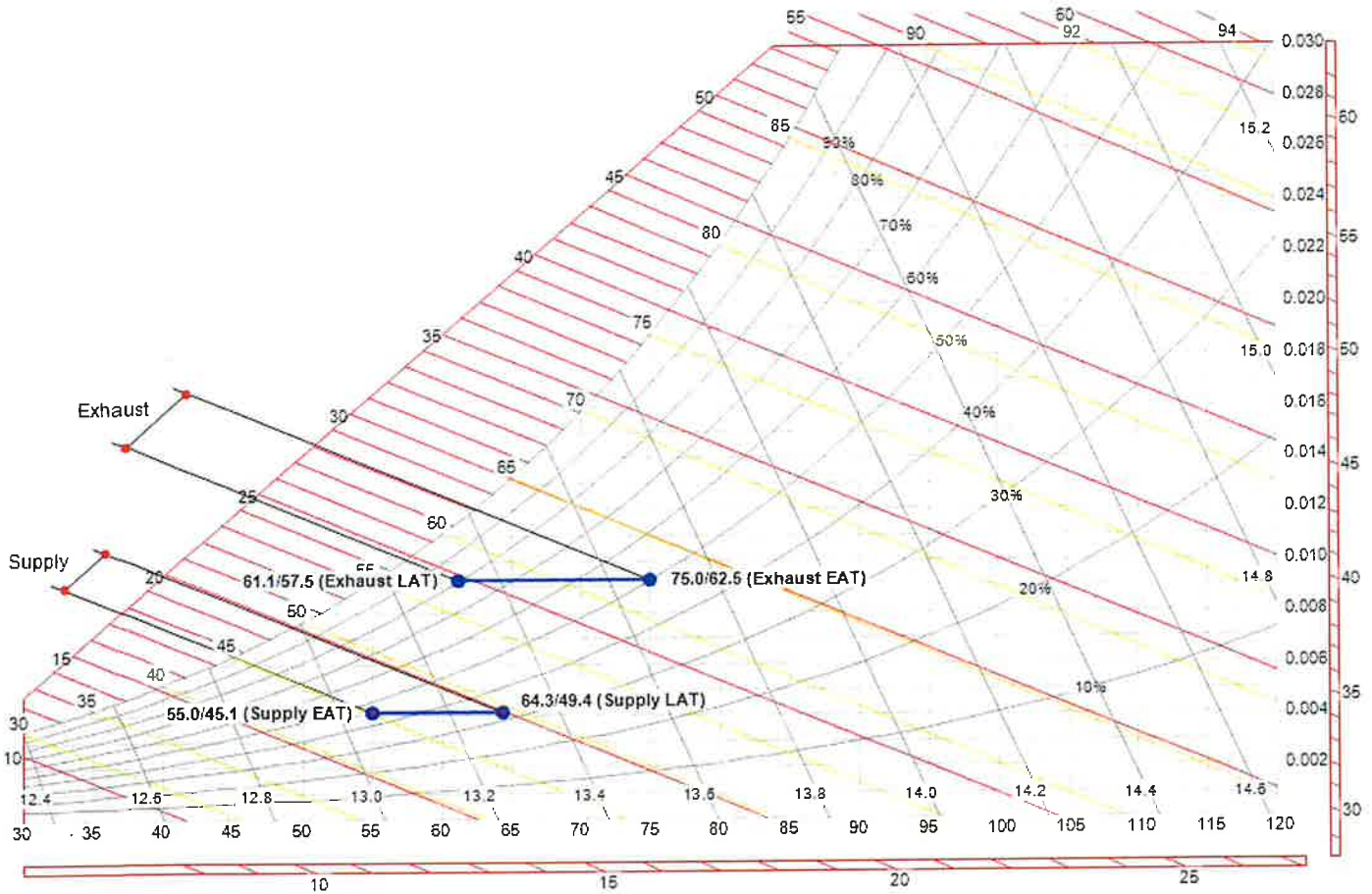

Qty:	Model:	Tag:	Order Code:
1	HRM	Cafeteria	HO-AMG-10812A-07125-04500-3200F-04500-XXM

**Drawing**

Tubes	Material: Copper	Fins	Coating: None	Unit:	Rows: 8	Refrigerant: R410a	FPI: 12	Approval	Name:	Date:
Diameter: 1/2	Surface: Rifled	Material: Aluminum	Geometry: Sine Wave	Sheet Metal: 16 GA G90 Galvanized Steel	Weight: 1478	Company:	Signature:			

Order Code: HO-AMG-10812A-07125-04500-3200F-04500-XXM

- Note 1:** Heat Pipes used in this orientation have horizontal fins.
- Note 2:** Moisture Eliminator captures condensate droplets from airstream. Condensate drains from bottom of casing.
- Note 3:** Drain pans are required. They are not provided by the factory.
- Note 4:** Drain pan shall extend 2" beyond moisture eliminator.
- Note 5:** Unit ships horizontally and is installed vertically.

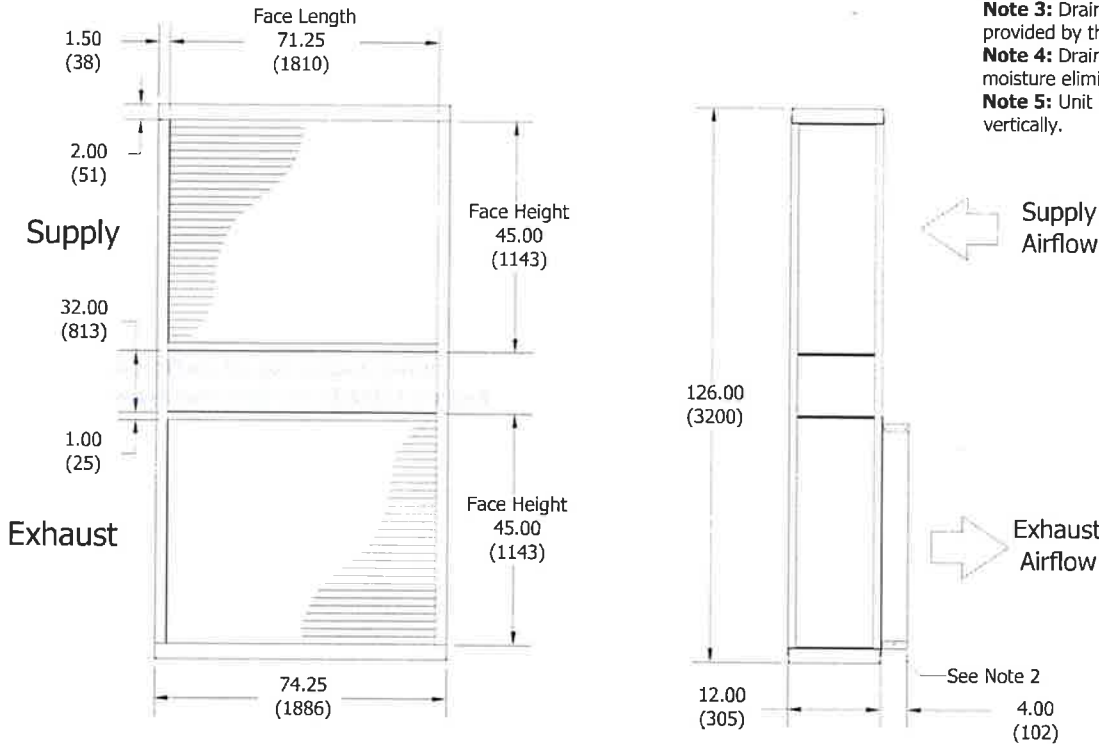

This drawing and/or data sheet is the confidential and proprietary information of HPT® and is not to be reproduced, copied or disclosed, in whole or in part, without the prior written consent of HPT®.  
 Copyright© 2017

Tolerances:  
 Unless specified  
 Fin Area: ±1/8 (3mm)  
 Sheet: ±3/16 (5mm)  
 Weight: ±10%  
 Length: inches (mm)  
 Weight: lbs

Project Name:  
 Windsor Public Schools

Unit Tag:  
 Cafeteria

Drawing No:  
 XX23OCT1892

Date:  
 10/23/2023 10:48

AM

Project No:  
 223626

Created By:  
 ecormier

Scale:  
 Not To Scale

HS1MG 11/12/2018

**SelectPlus™**  
**Design Software**  
 6904 Parke East Blvd, Tampa FL 33610  
 P: (813) 470-4250 www.heatpipe.com

## Moisture Eliminator

### Description

Blades are designed to capture condensate that forms on, and spits from, horizontal coil fins. The moisture eliminator will sit over a drain pan and captured condensate will drain out of the bottom of the moisture eliminator into the pan.

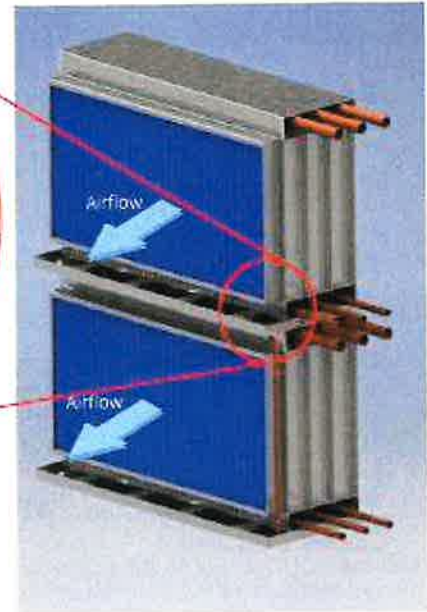
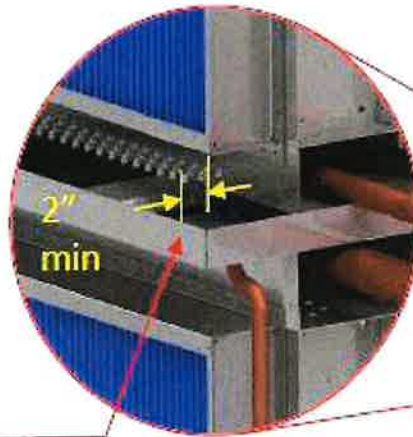
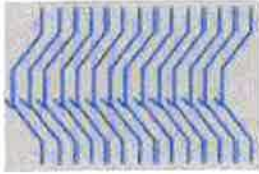

- Intermediate drain pans are required when multiple heat pipe sections are stacked vertically
- All drain pans to extend a minimum of 2" past the moisture eliminator casing

### Materials of Construction

Moisture Eliminator Casing is either 16ga G90 Galvanized or 16ga 304 Stainless Steel. Moisture Eliminator Blades are made from extruded ABS plastic. Blade material is enhanced with UV resilient and anti-fungal additives. Blade material meets UL 94 V-0 Flammability requirements.

### Performance

At least 99.75% of condensate will be captured by the moisture eliminator, when the coil is producing condensate at a rate of 0 to 15 lbs<sub>water</sub> /sqft/hour and coil airflow is ≤ 700 SFPM

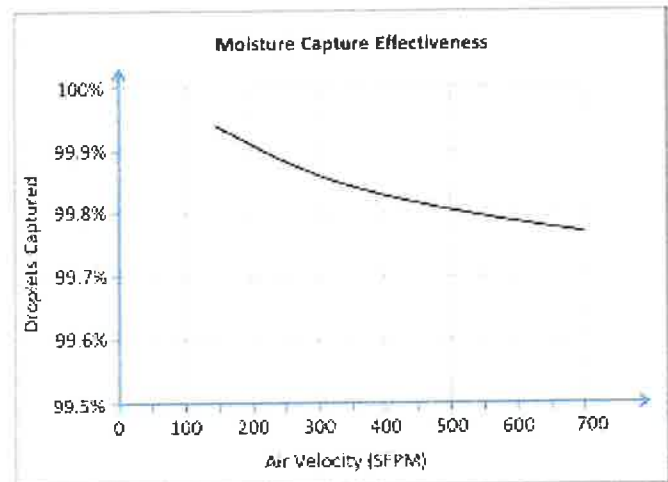
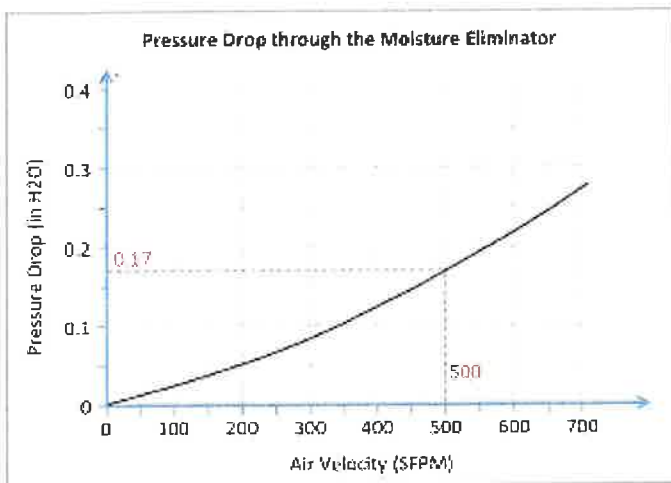

**HRM warranty**

## Energy Recovery Heat Pipes (Module Only) Five-Year Limited Warranty

---

Subject to the following conditions, **Heat Pipe Technology, Inc. (HPT)**, warrants this product to be free from defects in material and workmanship for a period of FIVE YEARS for the heat exchanger only from the date of installation not to exceed 90 days from date of shipment. Dampers and HPT provided controls carry a 12 month warranty. This warranty is in lieu of all other warrants not expressly set forth herein, whether expressed or implied by operation of law or otherwise. In the event this product fails under normal use and service within the applicable period, HPT will correct, repair or, at its sole discretion, replace the defective product or refund the purchase price of products which are returned freight prepaid to HPT for inspection, when accompanied by proof of purchase and written claims of defect, and which upon inspection by HPT, do comply with the terms of this warranty.

This warranty applies to the first retail buyer and extends to any subsequent owners of the systems.

The cost of replacement parts or components shall be determined by the price schedule in effect at the time of submission of warranty claim.

Repair or replacement parts will be furnished F.O.B. factory in all cases.

If HPT elects to replace or provide a refund, the defective product must be returned to HPT free and clear of liens or other encumbrances.

### Limitations on Liability

**This warranty does not cover and no warranty is made with respect to:**

- A. Failures not reported to HPT within the period specified above;
- B. Failures or damage due to misapplication, misuse, abuse, improper storage or handling, abnormal conditions of temperature, water, dirt, corrosive substances or other contaminants;
- C. Products which have been repaired with parts or materials not furnished or approved by HPT or by its authorized dealers or representatives, or products which have been in any way tampered with or altered;
- D. Products damaged in shipment or storage or otherwise without fault of HPT;
- E. Normal maintenance as outlined in the installation and servicing instructions or owners manual including coil cleaning, filter cleaning and periodic flushing of systems;
- F. Damage or repairs required as a consequence of faulty installation or application by others;
- G. Damage or repairs required as a consequence of any misapplication, abuse, improper servicing, unauthorized alteration or improper operation;
- H. Damage as a result of floods, winds, fires, lightning, accidents, corrosive atmosphere or other conditions beyond the control of HPT;
- I. Damage resulting from freezing of domestic water or condensate, inadequate or interrupted water supply, use of corrosive water, fouling or restriction of the water circuit by foreign material or like causes;
- J. Damage resulting from operation with an inadequate supply of air or water;
- K. Dampers or other mechanical options.

HPT total responsibility for any claims, damages, losses or liabilities related to the product covered hereunder shall not exceed the purchase price of such product. In no event shall HPT be liable for any special, indirect, incidental or consequential damages of any character, including but not limited to loss of use of productive facilities or equipment, lost profits, property damage, transportation, installation or removal, lost production, or personal injury whether suffered by Purchaser or any third party. HPT disclaims all liability for any and all costs, claims, demands, charges, expenses or other damages, either direct or indirect, incident to personal injury or property damage arising out of any cause of action based on strict liability.

Some states do not allow the exclusion or limitation of incidental or consequential damages or limitations on how long an implied warranty lasts, so the exclusion or limitation above of consequential damages or the limitation of time above on implied warranties may not apply to you.

This warranty gives you specific legal rights and you may have other rights which may vary from state to state.

APPENDIX C

DOAS Units  
Equipment Cutsheets



## VXE-112-36D-10A-1-D1

### Unit Performance

Design Conditions						
Elevation (ft)	Summer		Winter DB (F)	Supply (CFM)	Outdoor Air (CFM)	Exhaust Air (CFM)
	DB (F)	WB (F)				
180	91.0	73.0	0.0	3,200	3,200	3,200

Unit Specifications						
Qty	Weight (lb)	Cooling Type	Primary Heating Type	Secondary Heating Type	Unit Installation	Unit ETL Listing
1	3,631 (+/- 5%)	Air-Source Heat Pump	Air-Source Heat Pump	Electric	Outdoor	UL/cUL 1995/60335-2-40

Configuration			
Outdoor Air		Exhaust Air	
Intake	Discharge	Intake	Discharge
End	Side	Access Side	Side

ASHRAE 90.1 Compliance			
	ASHRAE 90.1 Min. Efficiency	Calculated Efficiency	Compliance
ISMRE (ASHRAE 90.1-2019)	5.2	6.4	✓
ISMRE2 (ASHRAE 90.1-2022)	5	7.5	✓
ISCOP (ASHRAE 90.1-2019)	3.3	5	✓
ISCOP2 (ASHRAE 90.1-2022)	3.2	4.26	✓
Enthalpy Recovery Ratio (%)	50	60.4	✓

Energy Recovery Performance									
Design Condition	Temperature (F)								Capacity Reduction (BTU/h)
	Outdoor Air		Supply Air		Return Air		Exhaust Air		
	DB	WB	DB	WB	DB	WB/RH	DB	WB	
Summer	91.0	73.0	81.0	67.0	75.0	62.5/50	85.0	69.2	73,440.0
Winter	0.0	-1.5	41.6	35.9	72.0	55.8/35	27.4	26.8	143,770.0

Cooling Specifications						
Type	Total Capacity (MBH)	Sensible Capacity (MBH)	Coil (DB/WB)		Reheat	
			EAT (F)	LAT (F)	Capacity (MBH)	LAT (F)
Air-Source Heat Pump	134.6	96.5	81.0 / 67.0	53.6 / 53.3	62.8	71.7

Primary Heat Specifications				
Type	Total Capacity (MBH)	Dry Bulb Temperatures		
		EAT (F)	LAT (F)	Ambient Outdoor Air (F)
Air-Source Heat Pump	58.5	46.2	63.1	10.0

Secondary Heat Specifications							
Type	Capacity (kW)	Full Load Amps (FLA)	Capacity Control	Performance (w/ASHP)		Performance (w/o ASHP)	
				EAT (F)	LAT (F)	EAT (F)	LAT (F)
Electric	35.0	43.93	Modulating (SCR)	63.1	97.6	41.6	76.2

Air Performance							
Type	Total Volume (CFM)	External SP (in. wg)	Total SP (in. wg)	FRPM	Fan		
					Qty	Type	Drive-Type
Supply	3,200	1.5	3.843	2077	1	Plenum	Direct
Exhaust	3,200	1.25	3.09	2012	1	Plenum	Direct



Printed Date: 11/07/2023  
Job: Oliver Ellsworth MS  
Mark: ASHP-1 w EH  
Model: VXE-112-36D-10A-1-D1

Motor Specifications						
Motor	Qty	Operating Power (hp)	Size (hp)	Enclosure	Efficiency	RPM
Supply	1	3.08	5	ODP	PE	1750
Exhaust	1	2.82	5	ODP	PE	1750

Electrical Specifications					
Power Supply	Rating (V/C/P)	MCA (A)	MOP (A)	FLA (A)	Fan Power (W/CFM)*
Unit	460/60/3	90.7	100.0	77.6	1.376

\*Fan Power (W/CFM) = (Supply BHP + Exhaust BHP) / Supply CFM

### Construction Features And Accessories

Unit	
Unit Installation - Outdoor	Std
Unit Construction - Double Wall	Std
Insulation - 2 inch 2.4# R13 foam	Std
Corrosion Resistant Fasteners	Std
Hinged Access	Std
Factory Wired Non-Fused Disconnect Switch	X
Direct Drive Plenum Blower & Motor Assemblies	Std
Factory Wired VFDs	Std
Unit Finish - Permatector, Concrete Gray (RAL 7023)	X
Stainless Steel Condensate Drain Pan and Connection	Std
Condensate Drain Trap	Std
Short Circuit Current - 5 kA	Std
Energy Recovery Device - Polymer Wheel w/ Silica Gel Desiccant	Std
Controls	
Unit Controls - Full Control	Std
Internally Mounted Control Center with 24 VAC control transformer(s) and control circuiting fusing	Std
BMS Protocol - BACNetMSTP	X
BMS Monitoring Points	
Supply Fan Control - Constant Volume-Adj. Setpoint	X
Exhaust Fan Control - Constant Volume-Adj. Setpoint	X
Economizer Control - Temp./Enthalpy	X
Exhaust Fan Only Power	
Web-Based User Interface	Std
Energy Wheel Economizer Control - Modulating Wheel, OA Temp Setpoint w/VFD Wheel	X
Energy Wheel Rotation Sensor	Std
Damper Control - Constant Volume-Adj. Setpoint	X
Unoccupied Recirc Mode	
Control Accessories	
Remote Display	
Dirty Filter Sensor(s)	
Airflow Monitor	
Room Thermostat	
Phase/Brownout Protection	Std
Economizer Fault Detection Diagnostics	

Accessories	
Frost Control - Modulating Wheel	X
Outdoor Air Damper - Low Leakage	X
Return Air Damper - Low Leakage	X
Roof Curb - GKD - 45.9/173.9-G14	X
Supply Air Filters - 2" Merv 8 And 2" Merv 13, 8-20x20x2	X
Service Outlet - Shipped loose and powered by others	X
Piping Vestibule	
Service Lights	
Condensate Overflow Switch	X
Spare Filters - Both, Qty: 1 set(s)	X
Exhaust Discharge Gravity Backdraft Damper	Std
ElectroFin Coil Coating	
Motor Shaft Grounding	X
Return Air Filters - 2" Merv 8, 2-20x25x2	Std
Outdoor Air Filters - 2" Merv 8, 2-20x25x2	Std
Furnace Control	
Spare Energy Wheel Belt	
Spare Energy Wheel Segments	
UV Lights	
Bipolar Ionization	
Smoke Detector(s)	
Barometric Relief Damper	
Energy Wheel Bypass Damper	
Hail Guards	X
Warranty Options	
Unit Warranty - 18 Months (Std.)	Std
Energy Wheel Warranty - 5 Yrs Less Motor	Std
Compressor Warranty - 5.5 Yrs. (4 Yrs. Extended)	X

Standard Option	Std
Not Included	
Included	X

#### Notes

Outdoor Air Damper supplied is low leakage, motorized VCD-23 (leakage rate of 3 CFM / ft<sup>2</sup> @ 1 in. wg), Class 1A  
 Return Air Damper supplied is low leakage, motorized VCD-23 (leakage rate of 3 CFM / ft<sup>2</sup> @ 1 in. wg), Class 1A  
 Air-Source Heat Pump heating is locked below 10°F (-12.2°C). Above 10°F (-12.2°C), unit may go into defrost or extended lock out (until weather pattern changes) during high humidity or precipitation events. Without supplemental heat, supply discharge temperature may be extremely low during defrost. To avoid this, consider selecting supplemental heat.

### Supply Fan Charts And Performance

Supply Fan Performance									
Total Volume (CFM)	External SP (in. wg)	Total SP (in. wg)	RPM	Operating Power (hp)	Motor		Fan		
					Qty	Size (hp)	Qty	Type	Drive-Type
3,200	1.5	3.843	2077	3.08	1	5	1	Plenum	Direct

Pressure Drop (in. wg)							
Weatherhood	Filter	Damper	Cooling	Heating	External	Energy Wheel	Total
0.08	0.304	0.04	0.304	0.304	1.5	1.28	3.843

Sound Performance in Accordance with AMCA										
Sound Power by Octave Band								Lwa	dBA	Sones
62.5	125	250	500	1000	2000	4000	8000			
76	82	85	76	71	67	73	63	81	69	17

\*Energy Wheel pressure drop shown in above table also accounts for pressure drop across MERV8 OA filter

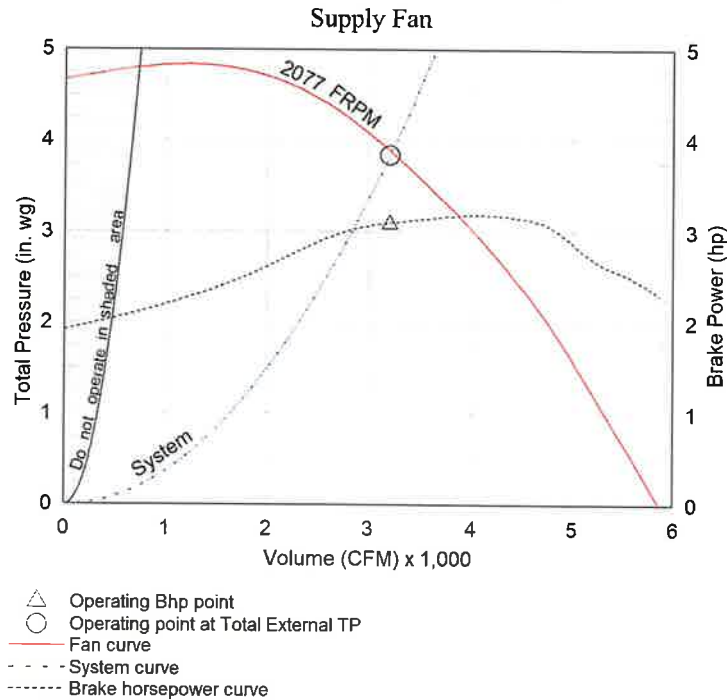

### Exhaust Fan Charts And Performance

Exhaust Fan Performance									
Total Volume (CFM)	External SP (in. wg)	Total SP (in. wg)	RPM	Operating Power (hp)	Motor		Fan		
					Qty	Size (hp)	Qty	Type	Drive-Type
3,200	1.25	3.09	2012	2.82	1	5	1	Plenum	Direct

Pressure Drop (in. wg)							
Weatherhood	Filter	Damper	Cooling	Heating	External	Energy Wheel	Total
0.13	-	-	-	-	1.25	1.71	3.09

Sound Performance in Accordance with AMCA								Lwa	dBA	Sones
Sound Power by Octave Band										
62.5	125	250	500	1000	2000	4000	8000			
81	72	80	73	69	67	67	61	77	65	14

\*Energy Wheel pressure drop shown in above table also accounts for pressure drop across MERV8 return air filter

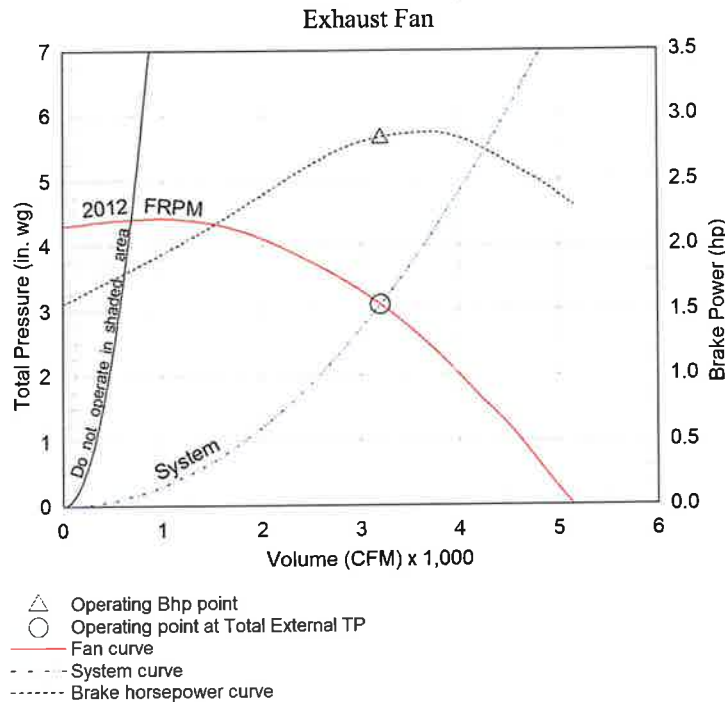

### Radiated Sound

#### Position A

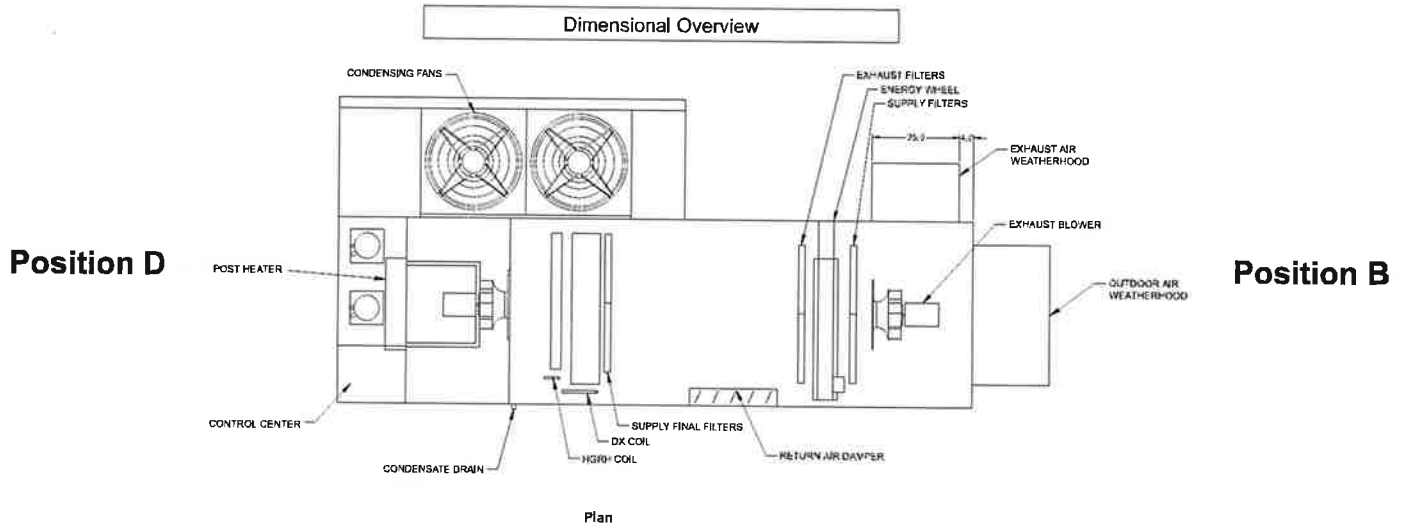

#### Position C

"E" is the Top Plane

Supply Air Flow Nominal, Largest Tonnage Condensing Section Available, PDX units only

Radiated Sound Levels										
Plane	Octave Bands (Lw)								Plane Lw	Plane LwA
	1	2	3	4	5	6	7	8		
A	73	86	81	79	77	73	69	63	89	82
B	71	79	77	71	69	64	63	55	82	75
C	79	76	69	66	64	59	53	46	81	69
D	74	77	72	72	69	62	58	51	81	74
E	77	84	80	76	76	70	66	60	87	80
<b>Total</b>	83	89	85	82	81	76	72	65	92	85

AMCA 320-07 - Laboratory Methods of Sound Testing of Fans Using Sound Intensity
Tests conducted in accordance with this standard.
Free field measurement plane created 1 foot from unit on all sides and top.
Sound Intensity measured in Watts/m <sup>2</sup> .
Sound data converted to Sound Power (Lw) for the chart above.
A-Weighted Sound Power was determined using AMCA Standard 301-90 Clause 9.1.
Plane E sound data was measured above the top plane of the unit.

### Air-Source Heat Pump Performance

Coil Information						
Indoor Coil Model	Fins Per Inch	Rows Deep	Face Vel. (ft/min)	Coil PD (in. wg)	Refrigerant	Face Area (ft <sup>2</sup> )
DX38S06S12-42x42.5-LH	12	6	258	0.304	R-410A	12

Compressor Details					
Lead Compressor Type	Compressor Qty	Compressor RLA/MRC (A)		Compressor LRA (A)	
		Comp. #1	Comp. #2	Comp. #1	Comp. #2
Inverter Scroll	2	8.3	7.8	NA	52

Cooling Specifications						
Type	Total Capacity (MBH)	Sensible Capacity (MBH)	Coil (DB/WB)		Reheat	
			EAT (F)	LAT (F)	Capacity (MBH)	LAT (F)
Air-Source Heat Pump	134.6	96.5	81.0 / 67.0	53.6 / 53.3	62.8	71.7

Primary Heat Specifications				
Type	Total Capacity (MBH)	Dry Bulb Temperatures		
		EAT (F)	LAT (F)	Ambient Outdoor Air (F)
Air-Source Heat Pump	58.5	46.2	63.1	10.0

Unit Details
Refrigerant charges provided by the factory are approximate and may require adjustment in the field
Hermetic scroll type compressors
Compressors mounted on neoprene vibration isolation
Crankcase heater on staged compressor
Electronic expansion valve on lead circuit, thermostatic expansion valve on staged circuit
Stainless steel double sloped drain pan
Moisture-indicating sight glass
Service/charging valves
Refrigerant high pressure switch (manual reset)
Liquid-Line filter drier
Multiple low sound outdoor fans with Lead ECM outdoor fan for modulating head pressure control
Inverter scroll compressor

**Important Notes:**  
 Air-Source Heat Pump heating is locked below 10°F (-12.2°C). Above 10°F (-12.2°C), unit may go into defrost or extended lock out (until weather pattern changes) during high humidity or precipitation events. Without supplemental heat, supply discharge temperature may be extremely low during defrost. To avoid this, consider selecting supplemental heat.

### Secondary Heat Performance

Secondary Heat Specifications							
Type	Capacity (kW)	Full Load Amps (FLA)	Capacity Control	Performance (w/ASHP)		Performance (w/o ASHP)	
				EAT (F)	LAT (F)	EAT (F)	LAT (F)
Electric	35.0	43.93	Modulating (SCR)	63.1	97.6	41.6	76.2

Unit Details
Open coil heating elements
High grade Nickel-Chrome alloy coils
SCR controller
Unit controller maximum allowable supply discharge air set point is 100F (37.8C)
Heat pump and electric heater can operate simultaneously. Unit MCA/MOP will be sized for concurrent operation of all loads

### Energy Recovery Summer Performance

Outdoor Air		ENERGY WHEEL	Supply Air	
Dry Bulb (F)	91.0		Dry Bulb (F)	81.0
Wet Bulb (F)	73.0		Wet Bulb (F)	67.0
Specific Humidity (gr/lb)	94		Specific Humidity (gr/lb)	77
Enthalpy (BTU/lb)	36.7		Enthalpy (BTU/lb)	31.6
Exhaust Air			Return Air	
Dry Bulb (F)	85.0	Dry Bulb (F)	75.0	
Wet Bulb (F)	69.2	Rel. Humidity (%)	50	
Specific Humidity (gr/lb)	82	Specific Humidity (gr/lb)	65	
Enthalpy (BTU/lb)	33.2	Enthalpy (BTU/lb)	28.2	

Design Air Flow Conditions			
OA Volume (CFM)	ASHRAE 90.1 OA Enthalpy Recovery Ratio	EA Volume (CFM)	EA Wheel Effectiveness
3,200	60.4	3,200	59.2

Outdoor Air Cooling Reduction				
OA Load w/o Energy Recovery		OA Load with Energy Recovery		Equipment Reduction (tons)
(BTU/h)	(tons)	(BTU/h)	(tons)	
122,400.0	10.20	48,960.0	4.08	6.12

### Summer Conditions

- 1 = Outdoor Air Design
- 2 = Energy Wheel
- 3 = DX Coil
- 4 = Hot Gas Reheat
- 5 = Exhaust Air Entering Wheel

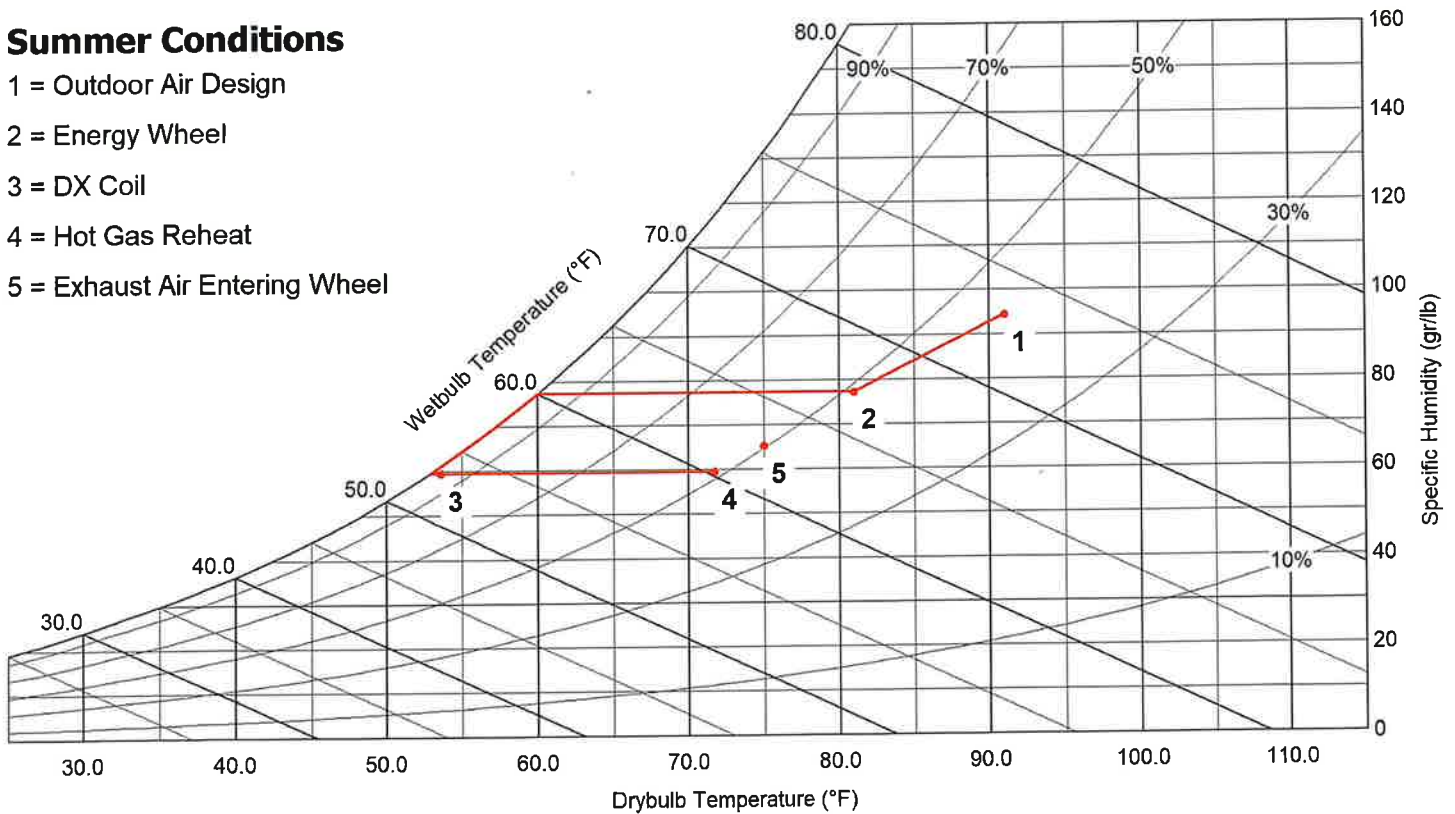

### Energy Recovery Winter Performance w/out Preheater

Outdoor Air		Supply Air	
Dry Bulb (F)	0.0	Dry Bulb (F)	41.6
Wet Bulb (F)	-1.5	Wet Bulb (F)	35.9
Specific Humidity (gr/lb)	3	Specific Humidity (gr/lb)	22
Enthalpy (BTU/lb)	0.4	Enthalpy (BTU/lb)	13.4
Exhaust Air		Return Air	
Dry Bulb (F)	27.4	Dry Bulb (F)	72.0
Wet Bulb (F)	26.8	Rel. Humidity (%)	35
Specific Humidity (gr/lb)	20	Specific Humidity (gr/lb)	41
Enthalpy (BTU/lb)	9.7	Enthalpy (BTU/lb)	23.7

Design Air Flow Conditions			
OA Volume (CFM)	ASHRAE 90.1 OA Enthalpy Recovery Ratio	EA Volume (CFM)	EA Wheel Effectiveness
3,200	55.8	3,200	59.3

Outdoor Air Heating Reduction			
OA Load w/o Energy Recovery (BTU/h)	OA Load with Energy Recovery (BTU/h)	Equipment Reduction (BTU/h)	Sensible Effectiveness (%)
248,832.0	105,062.0	143,770.0	61.5

### Winter Conditions

- 1 = Outdoor Air Design
- 2 = Energy Wheel
- 3 = Secondary Heating
- 4 = Exhaust Air Entering Wheel

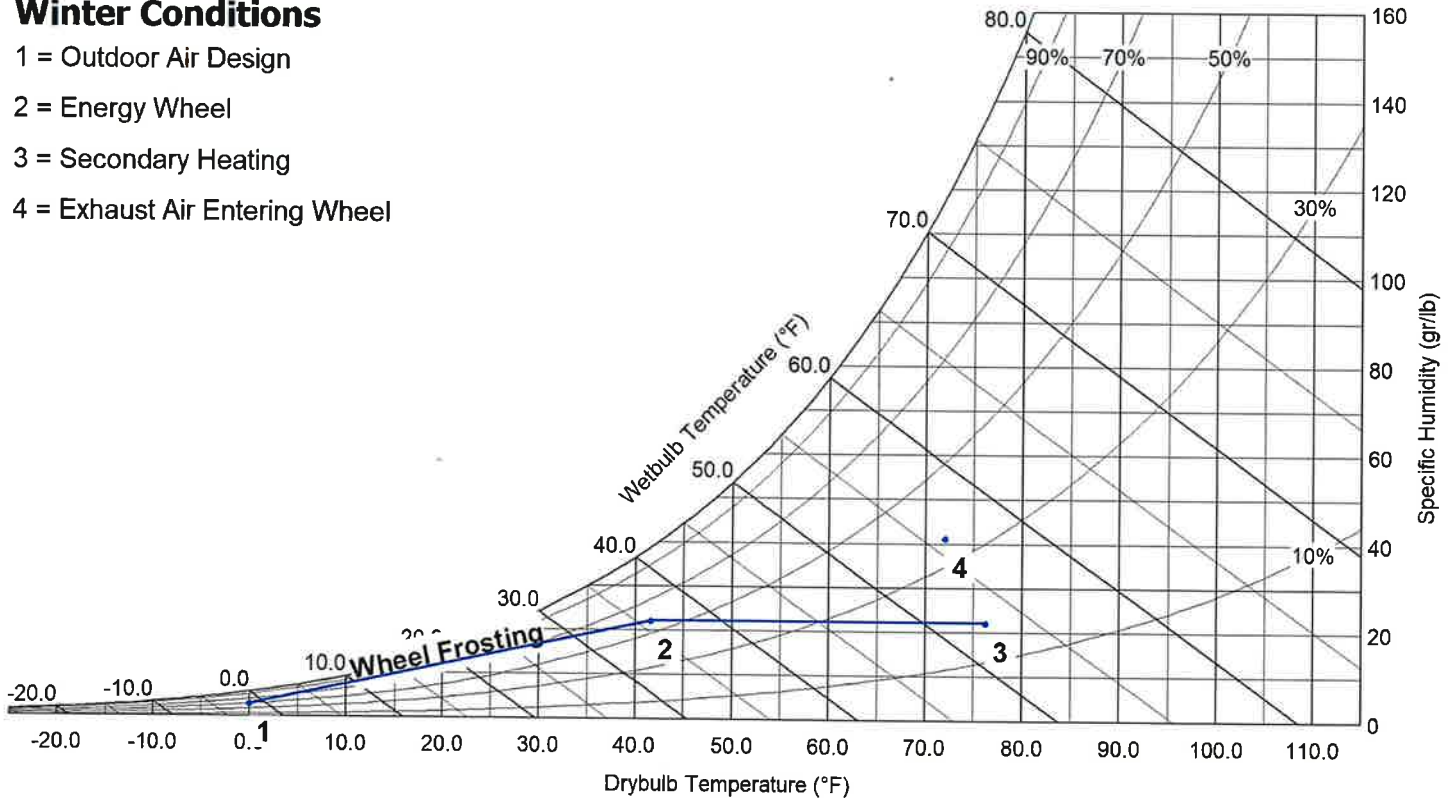

### AHRI Performance Ratings

#### Energy Recovery Performance Rating in accordance with AHRI Standard 1060 (I-P)

Rated Airflow (SCFM)		Net Supply Airflow (SCFM)	EATR (%)	OACF	Pressure Drop (in. wg)		Purge Angle (degrees)
Leaving Supply	Entering Exhaust				Supply	Exhaust	
3245	3245	3200	1.4	1.05	1.00	0.99	0

#### Thermal Effectiveness Ratings

Enthalpy Recovery		Sensible Effectiveness		Latent Effectiveness		Total Effectiveness	
Summer	Winter	Summer	Winter	Summer	Winter	Summer	Winter
60.4	55.8	61.9	61.5	56.7	53.9	59.2	59.3

#### Note(s)

##### Summer Design Conditions:

Certified in accordance with the AHRI ERV Certification Program, which is based on AHRI Standard 1060. Certified units may be found in the AHRI Directory at [www.ahridirectory.org](http://www.ahridirectory.org).



##### Winter Design Conditions:

Application Rating is outside the scope of the AHRI ERV certification Program but is rated in accordance with AHRI Standard 1060.

### Isometric Drawings

Component Layout

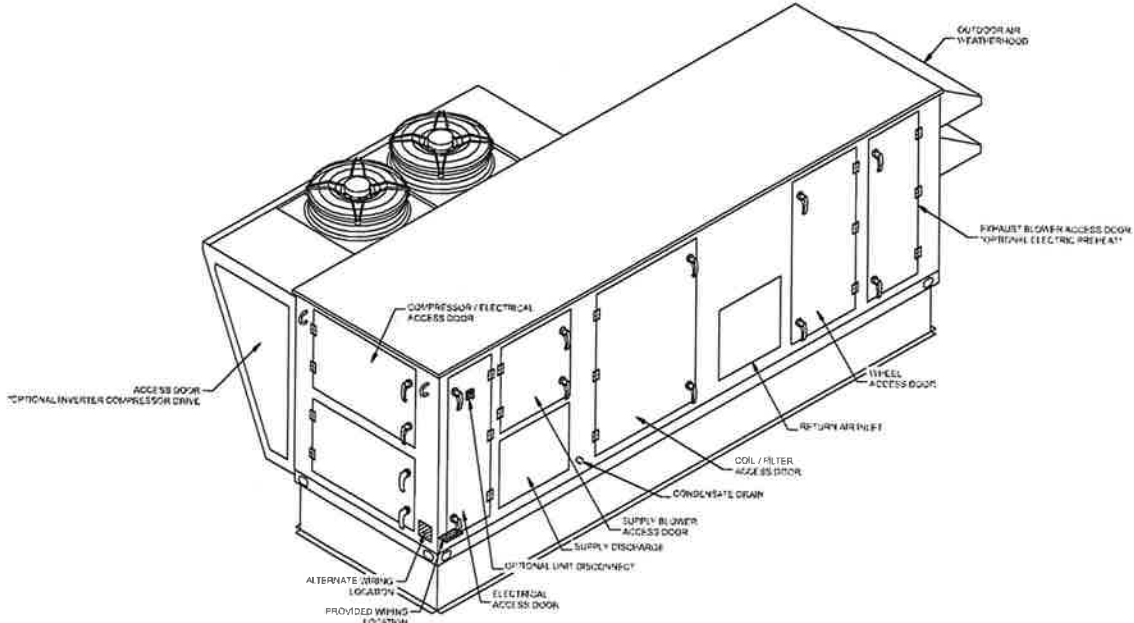

Back Right Isometric

Service Clearances

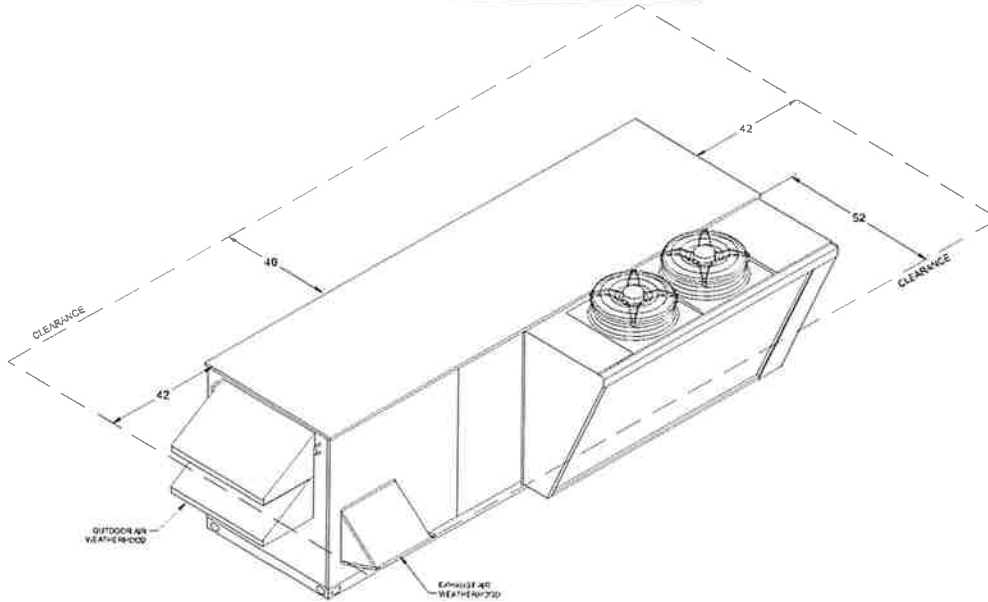

Front Left Isometric



### Unit Corner Weights

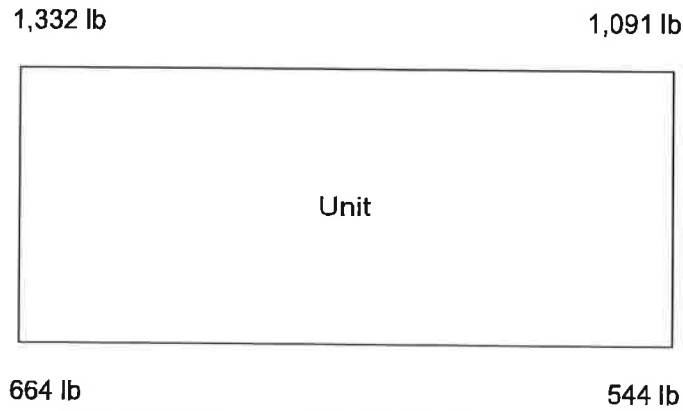

#### Note

Estimated corner weights are shown looking down on unit and the outside air intake will be on the right. Weights are applied at the base of the unit. Images not drawn to scale.

### Wiring Diagram



Wiring Diagram Code:

**V22Q2A1AF02G44X00NF23E0000BH29**

**CAUTION**  
 UNIT SHALL BE GROUNDED IN ACCORDANCE WITH N.E.C.  
 POWER MUST BE OFF WHILE SERVICING.

**NOTES**  
 USE COPPER CONDUCTORS ONLY  
 80° C FOR TERMINALS RATED LESS THAN 100 AMPS.  
 75° C FOR TERMINALS RATED 100 AMPS OR MORE.  
 FIELD CONTROL WIRING RESISTANCE SHOULD NOT EXCEED 0.75 OHM.  
 FIELD WIRED - - - - -  
 FACTORY SUPPLIED AND WIRED \_\_\_\_\_

**WIRE COLOR CODE**

BK	BLACK	BL	BLUE	BR	BROWN
GY	GRAY	LT BL	LIGHT BLUE	O	ORANGE
PK	PINK	PR	PURPLE	R	RED
W	WHITE	Y	YELLOW		

**LEGEND**

- CC# COMPRESSOR CONTACTOR
- CF# CONDENSING FAN CONTACTOR
- CH# COMPRESSOR SUMP HEATER
- DB# POWER DISTRIBUTION BLOCK
- DS# DISCONNECT SWITCH
- FU# FUSES
- PM# PHASE VOLTAGE MONITOR
- R1# ENERGY WHEEL CONTACTOR
- R3# EXHAUST BLOWER VFD RELAY
- R4# SUPPLY BLOWER VFD RELAY
- TR# TRANSFORMER
- VFD# VARIABLE FREQUENCY DRIVE

Wiring Template: H29 DOC NUMBER: 2888496 REV. 6

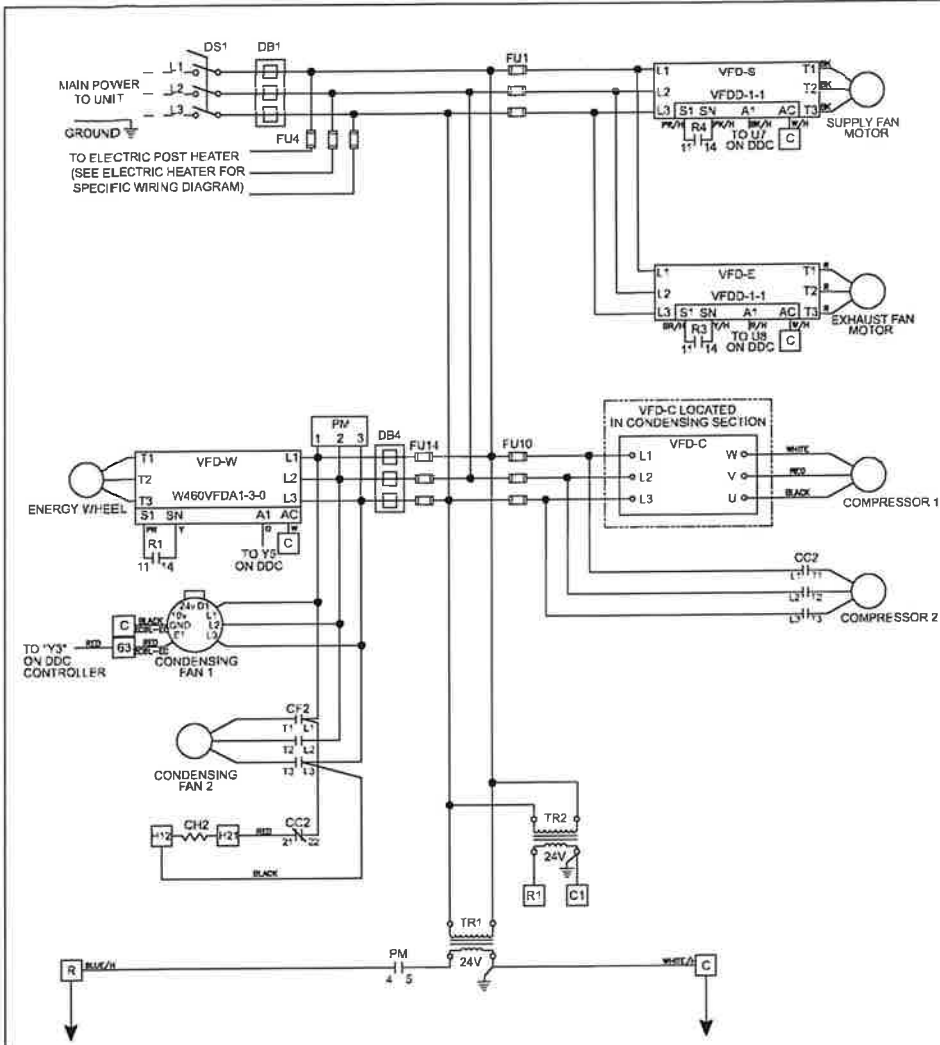

### Wiring Diagram 2

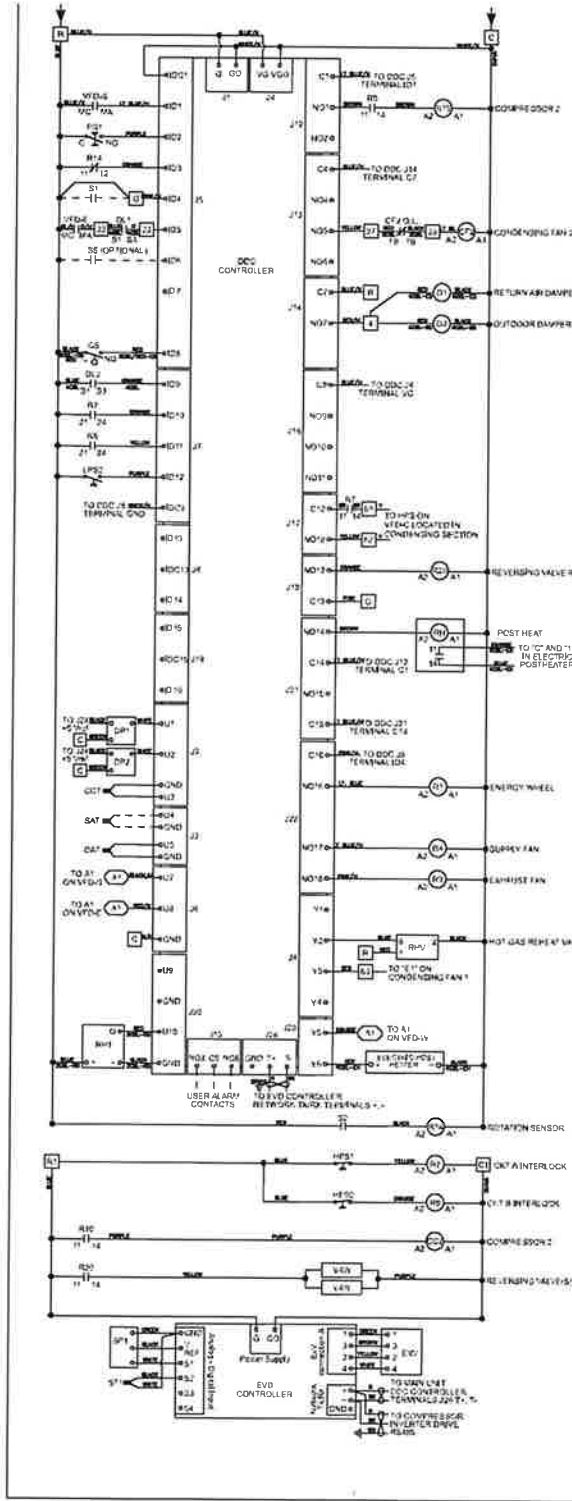

V22Q2A1AF02G44X00NF23E0000BG29

**CAUTION**  
 UNIT SHALL BE GROUNDED IN ACCORDANCE WITH N.E.C. POWER MUST BE OFF WHILE SERVICING.

**NOTES**  
 USE COPPER CONDUCTORS ONLY  
 97°C FOR TERMINALS RATED LESS THAN 100 AMPS  
 75°C FOR TERMINALS RATED 100 AMPS OR MORE  
 FIELD CONTROL WIRING RESISTANCE SHOULD NOT EXCEED 0.25 OHM  
 FIELD WIRING - - - - -  
 FACTORY SUPPLIED AND WIRED

**NOTE 1**  
 MODBUS COMMUNICATION WIRING: BARELY GRAB TO ALL MODBUS DEVICES, CONNECT ALL SHELD GROUNDS TOGETHER.

**WIRE COLOR CODE**

BK	BLACK	BL	BLUE	BR	BROWN
GY	GRAY	LT BL	LIGHT BLUE	OR	ORANGE
PK	PINK	PR	PURPLE	R	RED
W	WHITE	Y	YELLOW		

**LEGEND**

- CO1 COILING COIL ALWAYS TEMP
- CO2 COILING COIL TEMP
- CO3 COILING COIL TEMP
- CO4 COILING COIL TEMP
- CO5 COILING COIL TEMP
- CO6 COILING COIL TEMP
- CO7 COILING COIL TEMP
- CO8 COILING COIL TEMP
- CO9 COILING COIL TEMP
- CO10 COILING COIL TEMP
- CO11 COILING COIL TEMP
- CO12 COILING COIL TEMP
- CO13 COILING COIL TEMP
- CO14 COILING COIL TEMP
- CO15 COILING COIL TEMP
- CO16 COILING COIL TEMP
- CO17 COILING COIL TEMP
- CO18 COILING COIL TEMP
- CO19 COILING COIL TEMP
- CO20 COILING COIL TEMP
- CO21 COILING COIL TEMP
- CO22 COILING COIL TEMP
- CO23 COILING COIL TEMP
- CO24 COILING COIL TEMP
- CO25 COILING COIL TEMP
- CO26 COILING COIL TEMP
- CO27 COILING COIL TEMP
- CO28 COILING COIL TEMP
- CO29 COILING COIL TEMP
- CO30 COILING COIL TEMP
- CO31 COILING COIL TEMP
- CO32 COILING COIL TEMP
- CO33 COILING COIL TEMP
- CO34 COILING COIL TEMP
- CO35 COILING COIL TEMP
- CO36 COILING COIL TEMP
- CO37 COILING COIL TEMP
- CO38 COILING COIL TEMP
- CO39 COILING COIL TEMP
- CO40 COILING COIL TEMP
- CO41 COILING COIL TEMP
- CO42 COILING COIL TEMP
- CO43 COILING COIL TEMP
- CO44 COILING COIL TEMP
- CO45 COILING COIL TEMP
- CO46 COILING COIL TEMP
- CO47 COILING COIL TEMP
- CO48 COILING COIL TEMP
- CO49 COILING COIL TEMP
- CO50 COILING COIL TEMP
- CO51 COILING COIL TEMP
- CO52 COILING COIL TEMP
- CO53 COILING COIL TEMP
- CO54 COILING COIL TEMP
- CO55 COILING COIL TEMP
- CO56 COILING COIL TEMP
- CO57 COILING COIL TEMP
- CO58 COILING COIL TEMP
- CO59 COILING COIL TEMP
- CO60 COILING COIL TEMP
- CO61 COILING COIL TEMP
- CO62 COILING COIL TEMP
- CO63 COILING COIL TEMP
- CO64 COILING COIL TEMP
- CO65 COILING COIL TEMP
- CO66 COILING COIL TEMP
- CO67 COILING COIL TEMP
- CO68 COILING COIL TEMP
- CO69 COILING COIL TEMP
- CO70 COILING COIL TEMP
- CO71 COILING COIL TEMP
- CO72 COILING COIL TEMP
- CO73 COILING COIL TEMP
- CO74 COILING COIL TEMP
- CO75 COILING COIL TEMP
- CO76 COILING COIL TEMP
- CO77 COILING COIL TEMP
- CO78 COILING COIL TEMP
- CO79 COILING COIL TEMP
- CO80 COILING COIL TEMP
- CO81 COILING COIL TEMP
- CO82 COILING COIL TEMP
- CO83 COILING COIL TEMP
- CO84 COILING COIL TEMP
- CO85 COILING COIL TEMP
- CO86 COILING COIL TEMP
- CO87 COILING COIL TEMP
- CO88 COILING COIL TEMP
- CO89 COILING COIL TEMP
- CO90 COILING COIL TEMP
- CO91 COILING COIL TEMP
- CO92 COILING COIL TEMP
- CO93 COILING COIL TEMP
- CO94 COILING COIL TEMP
- CO95 COILING COIL TEMP
- CO96 COILING COIL TEMP
- CO97 COILING COIL TEMP
- CO98 COILING COIL TEMP
- CO99 COILING COIL TEMP
- CO100 COILING COIL TEMP

CONTROLLER BACNET NETWORK CONNECTION

FIELD WIRING BACNET NETWORK CONNECTION

SCAN FOR SUPPORT FILES

Wiring: 11/07/2023 DDC NUMBER: 220000 REV: 1

### Wiring Diagram 3

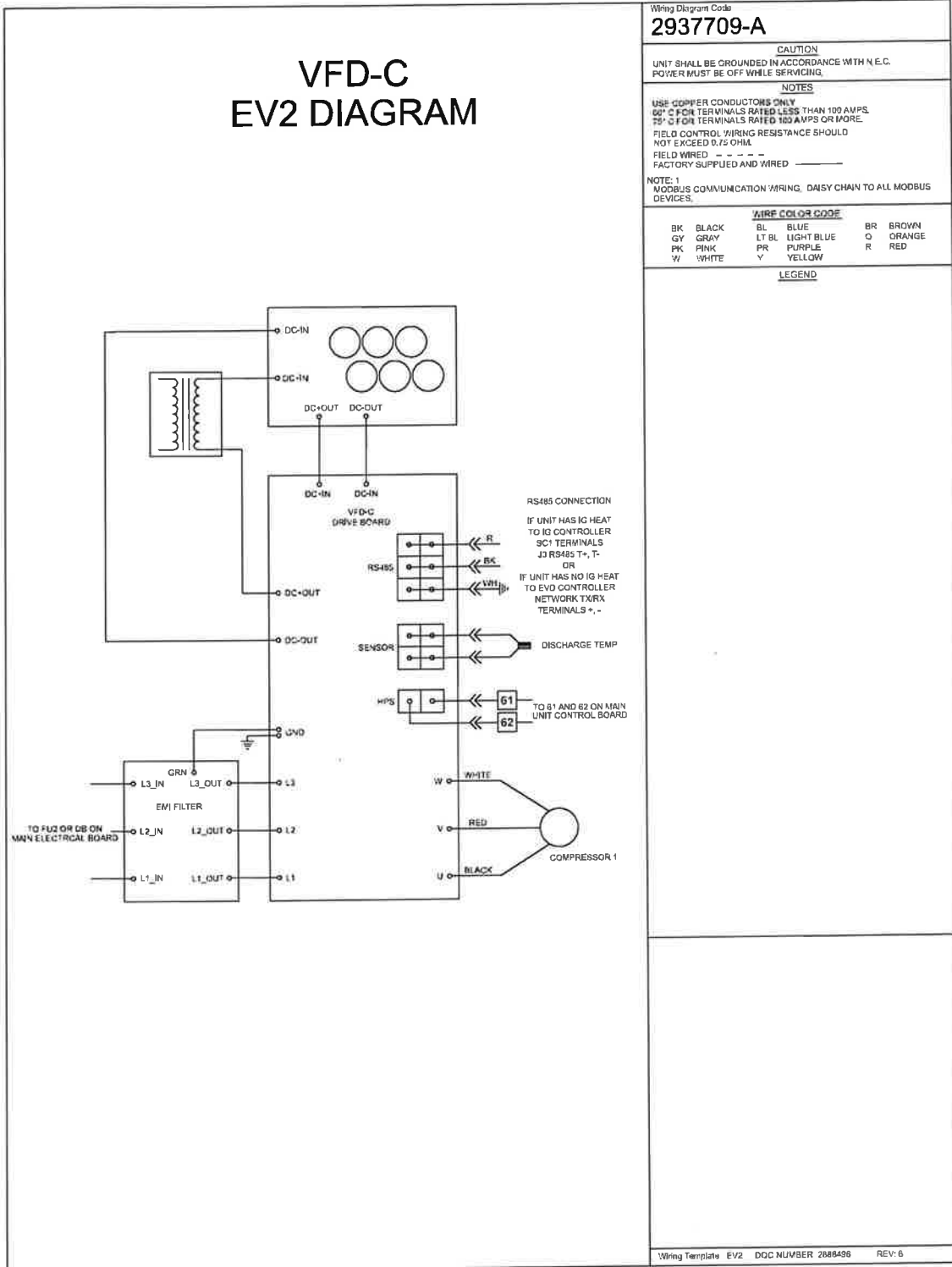

Wiring Template EV2 DOC NUMBER 2888496 REV: 6

**Valent Network Interface v8 Modbus/BACnet Points List**

Variable	Description	BACnet Object	ModBus Object	Read or Write	Text or Unit of M		Included
					Active	Inactive	
Space_Temp_Analog_Input	Space Temperature	AI-1	30002	R		°F	
Supply_Temp_Analog_Input	Supply Temperature	AI-2	30004	R		°F	X
Outside_Air_Temp_Analog_Input	Outside Air Temperature	AI-3	30006	R		°F	X
Mixed_Temp_Analog_Input	Mixed Temperature	AI-4	30008	R		°F	
Cold_Coil_1_Temp_Analog_Input	Cold Coil 1 Temperature	AI-5	30010	R		°F	X
Return_Temp_Analog_Input	Return Temperature	AI-7	30014	R		°F	
Exhaust_Temp_Analog_Input	Exhaust Temperature	AI-8	30016	R		°F	
Space_RH_Analog_Input	Space % Relative Humidity	AI-9	30018	R		%	
Outside_RH_Analog_Input	Outside % Relative Humidity	AI-10	30020	R		%	X
Return_RH_Analog_Input	Return % Relative Humidity	AI-11	30022	R		%	
Return_Duct_Static_Pressure_Analog_Input	Return Duct Static Pressure	AI-12	30024	R		"wc	
Space_Static_Pressure_Analog_Input	Space Static Pressure	AI-13	30026	R		"wc	
Supply_Duct_Static_Pressure_Analog_Input	Supply Duct Static Pressure	AI-14	30028	R		"wc	
Space_CO2_1_Analog_Input	Space 1 CO2 ppm	AI-15	30030	R		ppm	
Return_CO2_Analog_Input	Return CO2 ppm	AI-17	30034	R		ppm	
Circuit_A_Discharge_Temp_Analog_Input	Circuit A Discharge Temperature	AI-20	30040	R		°F	X
Circuit_A_Suction_Temp_Analog_Input	Circuit A Suction Temperature	AI-21	30042	R		°F	X
Circuit_B_Discharge_Temp_Analog_Input	Circuit B Discharge Temperature	AI-22	30044	R		°F	X
Circuit_B_Suction_Temp_Analog_Input	Circuit B Suction Temperature	AI-23	30046	R		°F	X
Circuit_A_Discharge_Pressure_Analog_Input	Circuit A Discharge Pressure	AI-28	30056	R		psig	X
Circuit_A_Suction_Pressure_Analog_Input	Circuit A Suction Pressure	AI-29	30058	R		psig	X
Circuit_B_Discharge_Pressure_Analog_Input	Circuit B Discharge Pressure	AI-30	30060	R		psig	X
Circuit_B_Suction_Pressure_Analog_Input	Circuit B Suction Pressure	AI-31	30062	R		psig	X
Aux_In_Customer_1	Customer defined auxiliary input	AI-36	30072	R		selectable	
Aux_In_Customer_2	Customer defined auxiliary input	AI-37	30074	R		selectable	
Aux_In_Customer_3	Customer defined auxiliary input	AI-38	30076	R		selectable	
Aux_In_Customer_4	Customer defined auxiliary input	AI-39	30078	R		selectable	
Aux_In_Customer_5	Customer defined auxiliary input	AI-40	30080	R		selectable	
Aux_In_Customer_6	Customer defined auxiliary input	AI-41	30082	R		selectable	
Aux_In_Customer_7	Customer defined auxiliary input	AI-42	30084	R		selectable	
Aux_In_Customer_8	Customer defined auxiliary input	AI-43	30086	R		selectable	
Aux_In_Customer_9	Customer defined auxiliary input	AI-44	30088	R		selectable	
Aux_In_Customer_10	Customer defined auxiliary input	AI-45	30090	R		selectable	
Temperature_Setpoint	Main Temperature Set point Supply, Space, or Return target temperature	AV-1	40002	RW		°F	X
Temperature_Heat_Cool_Deadband	Heat/Cool Spt Deadband when Room or Return control is active Clg Spt = Deadband /2 + Temp Spt Htg Spt = Deadband /2 - Temp Spt	AV-2	40004	RW		Delta in °F	
Temperature_Setpoint_Unoccupied	Main Temperature Set point Supply, Space, or Return target temperature	AV-3	40006	RW		°F	
Temperature_Heat_Cool_Deadband_Unoccupied	Heat/Cool Spt Deadband when Room or Return control is active Clg Spt = Deadband /2 + Temp Spt Htg Spt = Deadband /2 - Temp Spt	AV-4	40008	RW		Delta in °F	
Cooling_Coil_Setpoint_Min	Cooling Coil Leaving Air Setpoint	AV-5	40010	RW		°F	X
Cooling_Coil_Setpoint_Max	Maximum Coil Leaving Setpoint	AV-6	40012	RW		°F	X
Dehumidification_Setpoint	Dehumidification Setpoint %RH for Space or Return control	AV-7	40014	RW		%	
Outside_Dewpoint_Setpoint	Outside Dewpoint Dehumidification Trigger	AV-8	40016	RW		°F	X
Indoor_Dewpoint_Setpoint	Indoor Dewpoint Dehumidification Trigger	AV-9	40018	RW		°F	
Unocc_Indoor_Dewpoint_Setpoint	Unoccupied Indoor Dewpoint Dehumidification Trigger	AV-10	40020	RW		°F	
Unoccupied_Dehumidification_Setpoint	Unoccupied Dehumidification %RH Setpoint	AV-11	40022	RW		°F	
Economizer_Temp_Enable_Setpoint	Economizer Ambient Temp Enable Setpoint Allow Econ when OAT is less than Setpoint	AV-12	40024	RW		°F	
Economizer_Enthalpy_Enable_Setpoint	Economizer Enthalpy Enable Setpoint Allow Econ when OA Enthalpy is less than Setpoint	AV-13	40026	RW		btu/lb	X
Cooling_Lockout_Setpoint	Cooling Ambient Lockout Setpoint	AV-17	40034	RW		°F	X
Heating_Lockout_Setpoint	Heating Ambient Lockout Setpoint	AV-18	40036	RW		°F	X
Preheat_Lockout_Setpoint	Preheat Ambient Lockout Setpoint	AV-19	40038	RW		°F	
Economizer_Lockout_Setpoint	Economizer Ambient Lockout Setpoint	AV-20	40040	RW		°F	X
Return_Duct_Static_Pressure_Setpoint	Return Duct Static Pressure Setpoint	AV-21	40042	R		"wc	
Space_Static_Pressure_Setpoint	Space Static Pressure Setpoint	AV-22	40044	RW		"wc	
Supply_Duct_Static_Pressure_Setpoint	Supply Duct Static Pressure Setpoint	AV-23	40046	RW		"wc	
Space_CO2_Setpoint	Space CO2 Setpoint	AV-24	40048	RW		ppm	
Outside_Air_Damper_Minimum_Setpoint_Occ	Outside Air Damper Minimum Setpoint	AV-24	40050	RW		%	
Outside_RH_from_BMS	Outside RH from BMS Used when source selection is set to BMS	AV-26	40052	RW		%	X
Outside_Temp_from_BMS	Outside Temp from BMS Used when source selection is set to BMS	AV-27	40054	RW		°F	X
Return_RH_from_BMS	Return RH from BMS Used when source selection is set to BMS	AV-28	40056	RW		%	X
Return_Temp_from_BMS	Return Temp from BMS Used when source selection is set to BMS	AV-29	40058	RW		°F	X

**Valent Network Interface v8 Modbus/BACnet Points List**

Variable	Description	BACnet Object	ModBus Object	Read or Write	Text or Unit of M		Included
					Active	Inactive	
Space_1_CO2_from_BMS	Space 1 CO2 from BMS Used when source selection is set to BMS	AV-30	40060	RW		ppm	X
Return_CO2_from_BMS	Return CO2 from BMS Used when source selection is set to BMS	AV-32	40062	RW		ppm	X
Space_RH_from_BMS	Space RH from BMS Used when source selection is set to BMS	AV-33	40066	RW		%	X
Space_Static_from_BMS	Space Static from BMS Used when source selection is set to BMS	AV-34	40068	RW		"wc	X
Space_Temp_from_BMS	Space Temp from BMS Used when source selection is set to BMS	AV-35	40070	RW		"F	X
SF_Control_Signal_BMS	BMS to control signal for supply fan speed	AV-36	40072	RW		%	X
EF_Control_Signal_BMS	BMS to control signal for exhaust fan speed	AV-37	40074	RW		%	X
OAD_Control_Signal_BMS	Allows the BMS to control OAD position	AV-38	40076	RW		%	X
Aux_BMS_Analog_Output_1	BMS Commanded auxiliary analog output	AV-39	40078	RW		selectable	X
Unit_Status_Mode	Unit Status Mode - See Table	AV-40	30092	R		Real	X
Supply_Temperature_Calculated_Setpoint	Active Supply Temperature Setpoint	AV-41	30094	R		"F	X
Cooling_1_Ramp_Capacity	Cooling Ramp 1 Status Value	AV-42	30096	R		%	X
Defrost_Ramp	Defrost Ramp	AV-44	30100	R		%	X
Economizer_Ramp	Economizer Ramp	AV-45	30102	R		%	X
Head_Pressure_Control_Ramp_1_Ramp	Head Pressure Control Ramp 1	AV-46	30104	R		%	X
Head_Pressure_Control_Ramp_2_Ramp	Head Pressure Control Ramp 2	AV-47	30108	R		%	X
HP_Ramp_Capacity	Heat Pump Heating Ramp	AV-50	30112	R		%	X
Heating_Capacity	Heating Ramp	AV-51	30114	R		%	X
Case_Heat_Control_Ramp	Case Heat Ramp	AV-52	30116	R		%	X
Hot_Gas_Reheat_Ramp	Hot Gas Reheat Ramp	AV-53	30118	R		%	X
Outside_Dewpoint	Outside Dewpoint	AV-54	30120	R		"F	X
Outside_Enthalpy	Outside Enthalpy	AV-55	30122	R		btu/lb	X
Return_Dewpoint	Return Dewpoint	AV-56	30124	R		"F	
Return_Enthalpy	Return Enthalpy	AV-57	30126	R		btu/lb	
Space_Dewpoint	Space Dewpoint	AV-58	30128	R		"F	
Space_Enthalpy	Space Enthalpy	AV-59	30130	R		btu/lb	
Circuit_A_Superheat	Circuit A Superheat	AV-60	30132	R		"F	X
Circuit_B_Superheat	Circuit B Superheat	AV-61	30134	R		"F	X
Total_Exhaust_Fan_CFM_BMS	Total Exhaust Fan CFM	AV-64	30140	R		CFM	X
Total_Supply_Fan_CFM_BMS	Total Supply Fan CFM	AV-65	30142	R		CFM	X
OAD_CFM_BMS	OAD CFM	AV-66	30144	R		CFM	X
Active_Temperature_Setpoint	Active Temperature Setpoint	AV-67	30146	R		"F	X
Chilled_Water_1_Valve_Analog_Output	Chilled Water 1 Valve Analog Output	AV-68	30148	R		%	
Electric_Heater_1_Analog_Output	Electric Heater 1 Analog Output	AV-70	30152	R		%	
Energy_Recovery_Analog_Output	Energy Recovery Analog Output	AV-72	30156	R		%	X
Exhaust_Fan_Speed_Analog_Output	Exhaust Fan Speed Analog Output	AV-73	30158	R		%	X
Hot_Water_Valve_1_Analog_Output	Hot Water Valve 1 Analog Output	AV-74	30160	R		%	
Mod_Gas_Furnace_1_Analog_Output	Mod Gas Furnace 1 Analog Output	AV-76	30164	R		%	
Outside_Air_Damper_Analog_Output	Outside Air Damper Analog Output	AV-78	30168	R		%	
Supply_Fan_Speed_Analog_Output	Supply Fan Speed Analog Output	AV-79	30170	R		%	
Modulating_Compressor_Analog_Output_BMS	First Modulating Compressor Analog Output - BMS	AV-80	30172	R		%	X
Circuit_A_Sat_Discharge_Temperature	Circuit A Saturated Discharge Temperature	AV-82	30176	R		"F	X
Circuit_B_Sat_Discharge_Temperature	Circuit B Saturated Discharge Temperature	AV-83	30178	R		"F	X
Circuit_A_Sat_Suction_Temperature	Circuit A Saturated Suction Temperature	AV-86	30184	R		"F	X
Circuit_B_Sat_Suction_Temperature	Circuit B Saturated Suction Temperature	AV-87	30186	R		"F	X
Coil_Temperature_Calculated_Setpoint	Calculated Coil Leaving Set point	AV-90	30192	R		"F	X
Unoccupied_Cooling_Setpoint	Active Cooling Setpoint - Unoccupied	AV-91	30194	R		"F	
Unoccupied_Heating_Setpoint	Active Heating Setpoint - Unoccupied	AV-92	30196	R		"F	
Temperature_Resel_Mode	Occupied Resel Type Setpoint 1-No Resel(Supply Temp Control) 2-Space 3-Return 4-Outside	IV-1	40080	RW		Integer	X
Temperature_Resel_Mode_Unoccupied	Unoccupied Resel Type Setpoint 1-No Resel(Supply Temp Control) 2-Space 3-Return 4-Outside	IV-2	40082	RW		Integer	
Active_Temperature_Resel_Mode	Active Occupied Resel Type Setpoint 1-No Resel(Supply Temp Control) 2-Space 3-Return 4-Outside	IV-3	30198	R		Integer	X
Active_Temperature_Resel_Mode_Unocc	Active Unoccupied Resel Type Setpoint 1-No Resel(Supply Temp Control) 2-Space 3-Return 4-Outside	IV-4	30200	R		Integer	
LatestAlm	Most recent alarm - See Alarm Table	IV-5	30202	R		Integer	X
Device_Enable_DO_Word	Device Enable DO Word - See Table	IV-6	30206	R		Bit Pack	X
Ref_Ckt_PressTemp_Alarm_Word	Refrigeration Circuit Word - See Table	IV-7	30210	R		Bit Pack	X
Device_Offline_Word	Device Offline Word - See Table	IV-8	30214	R		Bit Pack	X
Device_Alarm_Word	Device Alarm Word - See Table	IV-9	30218	R		Bit Pack	X
System_Word	System Word - See Table	IV-10	30222	R		Bit Pack	X
Unit_Status_Word	Unit Status Word - See Table	IV-11	30226	R		Bit Pack	X
Exhaust_Fan_1_Status_Digital_Inpu	Exhaust Fan Status	BI-1	10009	R		Active Inactive	X
Supply_Fan_1_Status_Digital_Input	Supply Fan Status	B-2	10010	R		Active Inactive	X

**Valent Network Interface v8 Modbus/BACnet Points List**

Variable	Description	BACnet Object	ModBus Object	Read or Write	Text or Unit of M		Included
					Active	Inactive	
Exhaust_Fan_1_Status_Digital_Input	Exhaust Fan Status	BI-1	10009	R	Active	Inactive	X
Supply_Fan_1_Status_Digital_Input	Supply Fan Status	B-2	10010	R	Active	Inactive	X
BMS_Watchdog	BMS Watchdog command Used to determine BMS comm status Must heartbeat within the watch dog timeout delay to detect comm status	BV-1	2	RW	Active	Inactive	X
System_Enable	Master system enable/disable point	BV-2	3	RW	Enable	Disable	X
BMS_Occupancy_Command	Occupancy Command	BV-3	4	RW	Unoccupied	Occupied	X
Reset_All_Alarms	Alarm Reset Command	BV-4	5	RW	Reset	Normal	X
Exhaust_Only_Mode_BMS_Cmd	Emergency Exhaust Mode Command	BV-5	6	RW	Enable	Disable	
Pressurization_Only_Mode_BMS_Cmd	Emergency Pressurization Mode Command	BV-6	7	RW	Enable	Disable	
Outside_RH_Source_BMS	Outside RH Source Selection	BV-7	8	RW	BMS	Local	X
Outside_Temp_Source_BMS	Outside Temp Source Selection	BV-8	9	RW	BMS	Local	X
Return_RH_Source_BMS	Return RH Source Selection	BV-9	10	RW	BMS	Local	X
Return_Temp_Source_BMS	Return Temp Source Selection	BV-10	11	RW	BMS	Local	X
Space_1_CO2_Source_BMS	Space 1 CO2 Source Selection	BV-11	12	RW	BMS	Local	X
Space_2_CO2_Source_BMS	Space 2 CO2 Source Selection	BV-12	13	RW	BMS	Local	X
Return_CO2_Source_BMS	Return CO2 Source Selection	BV-13	14	RW	BMS	Local	X
Space_RH_Source_BMS	Space RH Source Selection	BV-14	15	RW	BMS	Local	X
Space_Static_Source_BMS	Space Static Source Selection	BV-15	16	RW	BMS	Local	
Space_Temp_Source_BMS	Space Temp Source Selection	BV-16	17	RW	BMS	Local	X
SF_Control_Source_BMS	Allows the BMS to control supply fan speed	BV-17	18	RW	BMS	Local	X
EF_Control_Source_BMS	Allows the BMS to control exhaust fan speed	BV-18	19	RW	BMS	Local	X
OAD_Control_Source_BMS	Allows the BMS to control OAD position	BV-19	20	RW	BMS	Local	
Aux_BMS_Digital_Output_1	BMS Commanded auxiliary digital output	BV-20	21	RW	Active	Inactive	
Aux_BMS_Digital_Output_2	BMS Commanded auxiliary digital output	BV-21	22	RW	Active	Inactive	
Occupied	Occupancy	BV-22	10002	R	Occupied	Unoccupied	X
Global_Alarm	General alarm point Optionally set to indicate any alarm is active, or a shutdown alarm is active	BV-23	10003	R	Alarm	Normal	X
BMS_Walchdog_Active	Status of the BMS walchdog heartbeat	BV-24	10004	R	Active	Inactive	X
OAD_Feedback_Error_Not_Economizing.Active	Feedback indicates OAD is not opening during economizer	BV-25	10005	R	Alarm	Normal	
OAD_Feedback_Error_Economizing.Active	Feedback indicates OAD is open	BV-26	10006	R	Alarm	Normal	
OAD_Feedback_Error_OAD_Not_Modulating.Active	Feedback indicates the OAD is not modulating	BV-27	10007	R	Alarm	Normal	
OAD_Feedback_Error_Excess_OA.Active	Feedback indicates the OAD is not dosing	BV-28	10008	R	Alarm	Normal	

System Word Table (IV-10)	
Bit	System_Word
0	Heat Wheel Enable
1	Preheat Enable
2	Reversing Valve (Cooling (0)/Heating(1))
3	
4	
5	
6	Supply Temp Low Limit Alarm
7	Supply Temp High Limit Alarm
8	Supply High Duct Static Alarm.Active
9	Supply Fan 1 Alarm
10	Exhaust Fan 1 Alarm
11	Drain Pan Alarm
12	Freeze Stat Alarm
13	Filter Alarm
14	Space High Static Alarm
15	Return Low Static Alarm
16	Shutdown Input Alarm
17	Energy Recovery Wheel High Diff Pressure
18	Energy Recovery Wheel Rotation Alarm
19	
20	Heat Pump Heating Lock Out Alarm
21	Permanent Memory - Too Many Writes
22	BMS Offline Alarm
23	
24	
25	
26	
27	
28	Heat-Cool Only - Dehumidification Request Active
29	Heat-Cool Only - Heating Request Active
30	Heat-Cool Only - Coil Setpoint Alarm Active
31	Heat-Cool Only - Supply Setpoint Alarm Active

Unit Status Word Table (IV-11)	
Bit	Unit_Status_Word
0	Off/Standby
1	Unoccupied Start
2	Occupied Start
3	Opening Dampers
4	Dampers Open
5	Fan Start Delay
6	Exhaust Fan On
7	Supply Fan On
8	System On
9	Soft Shutdown
10	System Disabled
11	Remote Off
12	System Shutdown Alarm
13	Supply Fan Only
14	Exhaust Fan Only
15	Purge Mode (Supply and Exhaust Only)
16	Case Heat Active
17	Fans Only
18	Economizing
19	Energy Recovery Active
20	Cooling
21	Heating
22	Dehumidifying
23	Hot Gas Reheat Active
24	HGRH Purging
25	Dehum w/Heat
26	Energy Recovery Defrost Active
27	Heat Pump Defrost Active
28	Morning Warm Up/Cool Down Active
29	Winter Ramp Active
30	
31	Overrides Active

Device Enable DO Word Table (IV-6)	
Bit	Device_Enable_DO_Word
0	Compressor 1 Start
1	Compressor 2 Start
2	Compressor 3 Start
3	Compressor 4 Start
4	
5	
6	
7	
8	Condenser Fan Ramp 1 Stage 1 Start
9	Condenser Fan Ramp 1 Stage 2 Start
10	Condenser Fan Ramp 1 Stage 3 Start
11	
12	Condenser Fan Ramp 2 Stage 1 Start
13	Condenser Fan Ramp 2 Stage 2 Start
14	Condenser Fan Ramp 2 Stage 3 Start
15	
16	Furnace 1 Start (External Furnace Controller Only)
17	Furnace 2 Start (External Furnace Controller Only)
18	
19	
20	Supply Fan Start
21	Exhaust Fan Start
22	
23	
24	
25	
26	
27	
28	
29	
30	
31	

Unit Status Word Table (IV-11)	
Bit	Ref_Ckt_PressTemp_Alarm_Word
0	Circuit A Discharge Pressure Sensor Alarm
1	Circuit A Discharge Temp Sensor Alarm
2	Circuit A Suction Pressure Sensor Alarm
3	Circuit A Suction Temp Sensor Alarm
4	Circuit B Discharge Pressure Sensor Alarm
5	Circuit B Discharge Temp Sensor Alarm
6	Circuit B Suction Pressure Sensor Alarm
7	Circuit B Suction Temp Sensor Alarm
8	Circuit A High Pressure Switch Alarm
9	Circuit A Low Pressure Switch Alarm
10	Circuit B High Pressure Switch Alarm
11	Circuit B Low Pressure Switch Alarm
12	Circuit A High Sat Discharge Temp Alarm
13	Circuit B High Sat Discharge Temp Alarm
14	
15	
16	
17	
18	
19	
20	
21	
22	
23	
24	
25	
26	
27	
28	
29	
30	
31	

Device Alarm Word Table (IV-9)	
Bit	Device_Alarm_Word -Ext
0	Cold Coil Temperature Sensor Alarm
1	
2	Mixed Temperature Sensor Alarm
3	Supply Duct Static Pressure Sensor Alarm
4	Supply Fan AFMS Alarm
5	Supply Air Temp Sensor Alarm
6	Exhaust Fan AFMS Alarm
7	Exhaust Temperature Sensor Alarm
8	Outside Air Temp Sensor Alarm
9	Outside RH Sensor Alarm
10	OAD AMD Alarm
11	Greentrol OAD AFMS Alarm
12	Return CO2 Sensor Alarm
13	Return Duct Static Pressure Sensor Alarm
14	Return Temperature Sensor Alarm
15	Return RH Sensor Alarm
16	Space CO2 Sensor Alarm
17	Space RH Sensor Alarm
18	Space Static Pressure Sensor Alarm
19	Space Temperature Sensor Alarm
20	IG Furnace Alarm
21	
22	Inverter Scroll 1 Alarm
23	
24	EVD Valve A Alarm
25	
26	SF VFD Alarm
27	
28	
29	
30	
31	

Device Offline Word Table (IV-8)	
Bit	Device_Offline_Word - Ext
0	Space TStat 1 Offline
1	Space TStat 2 Offline
2	Space TStat 3 Offline
3	Space TStat 4 Offline
4	VFD Offline Supply Fan
5	
6	
7	
8	Expansion Board 1 Alarm
9	Expansion Board 2 Alarm
10	Expansion Board 3 Alarm
11	Expansion Board 4 Alarm
12	
13	
14	
15	
16	
17	
18	
19	
20	
21	
22	
23	
24	
25	
26	
27	Master Unit Offline Alarm
28	Slave Unit 1 Offline Alarm
29	Slave Unit 2 Offline Alarm
30	Slave Unit 3 Offline Alarm
31	Slave Unit 4 Offline Alarm

UNIT STATUS MODE TABLE (AV-40)			
0	Off/Standby	17	Fans Only Purge
1	Unoccupied Start	18	Case Heat Active
2	Occupied Start	19	Fans Only
3	Opening Dampers	20	Economizing
4	Dampers Open	21	Cooling
5	Fan Start Delay	22	Heating
6	Exhaust Fan Start	23	Dehumidifying
7	Supply Fan Start	24	HGRH Purging
8	Startup Delay	25	Energy Recovery Defrost Active
9	System On	26	Dehumidifying w/Heat
10	Soft Shutdown	27	Overrides
11	System Disabled	28	Expansion Offline
12	Remote Off	29	Energy Recovery Active
13	System Shutdown Alarm	30	Hot Gas Reheat Active
14	Pressurization Only	31	Morning Warm Up/Cool Down Active (Sequence)
15	Exhaust Only	32	Heat Pump Defrost

Alarm Table (Latest Alarm IV-5)					
1	No Active Alarms	63	Supply Air Temperature - Low Limit Shutdown	117	High SDT Lockout - Circuit A
2	Supply Fan 1 Run - Status Not Proven	64	Heat Wheel Rotation - Not Detected	118	High SDT Lockout - Circuit B
3	Freeze Protection - Thermostat Tripped	65	Slave Unit 1 Offline -	121	Inverter 1 Alarm -
4	High Supply Duct - Static Pressure	66	Slave Unit 2 Offline -	123	Inverter 1 Lockout - Cycle Power to Unit
5	Low Return Duct - Static Pressure	67	Slave Unit 3 Offline -	125	High SDT Lockout - Circuit A
6	Outside Air Temp - Sensor Value Not Valid	68	Slave Unit 4 Offline -	126	Inverter 1 Foldback - Input Current
7	Supply Air Temperature - Sensor Value Not Valid	69	Master Unit Offline -	127	Inverter 1 Foldback - Inverter Temp
8	Cold Coil 1 Temp - Sensor Value Not Valid	70	Heat Pump Defrost - Mode is Active	131	Inverter 1 Comms Lost - Compressor Offline
9	Exhaust Air Temp - Sensor Value Not Valid	71	Multi Devices per Ch - Contact Tech Support	133	Space Thermostat 1 - Sensor Offline
10	Mixed Air Temperature - Sensor Value Not Valid	72	Shutdown Contact - In Alarm Position	134	Space Thermostat 2 - Sensor Offline
11	Return Air Temperature - Sensor Value Not Valid	73	Comp Maint Alarm - Run Hours Spt Reached	135	Space Thermostat 3 - Sensor Offline
12	Space Temperature - Sensor Value Not Valid	74	Supply Air Temperature - High Limit Shutdown	136	Space Thermostat 4 - Sensor Offline
13	Return Air RH - Sensor Value Not Valid	77	Space High Static Pres - Shutdown	137	IG Furnace 1 - No flame - after 3 tries
14	Space RH - Sensor Value Not Valid	78	Internal Board Temp - Exceeds -40F or 158F	139	IG Furnace 1 Large - no flame after 3 tries
15	Outside RH - Sensor Value Not Valid	79	BMS Offline - Watchdog is FALSE	139	IG Furnace 1 combust - fan high pressure sw
16	Low Pressure Switch - Circuit A	80	Clg Coil Setpt Input - Value is not valid	140	IG Furnace 1 Ignition - controller alarm
17	Low Pressure Switch - Circuit B	81	Sup Air Setpt Input - Value is not valid	141	IG Furnace 1 pressure - switch fault alarm
18	High Pressure Switch - Circuit A	82	BACnet License - Not Installed	142	High SDT Lockout - Circuit B
19	High Pressure Switch - Circuit B	83	Low Suction SH ExV A - EVD 1 Alarm	143	IG Furnace 1 - Max retrys
20	Damper End Switch Fail - Dampers are not open	84	Low Suction SH ExV B - EVD 1 Alarm	144	IG Furnace 1 - High Limit Trip
21	Exhaust Fan 1 Run - Status Not Proven	85	LOP A EVD 1 - Low Operating Pressure	145	IG Furnace - pCOe 1 Offline
22	Filters are Dirty - Replace Filters	87	MOP A EVD 1 - Max Operating Pressure	146	IG Furnace 1 IC fault - Check Furnace Wiring
23	Cond Drain Pan Full - Check Drain	89	EEV A EVD 1 - Motor Alarm	147	IG Furnace 2 No flame - after 3 tries
24	Exp Board 1 Status - Board is Offline	91	LowSuct A EVD 1 - Refrigerant Temp	148	IG Furnace 2 Large - no flame after 3 tries
25	Exp Board 2 Status - Board is Offline	93	High Condensing Temp - EVD 1	149	IG Furnace 2 combust - fan high pressure sw
26	Exp Board 4 Status - Board is Offline	94	Sens S1 EVD 1 - Sensor Value Not Valid	150	IG Furnace 2 Ignition - controller alarm
27	Non-Volatile Memory Er - Contact Tech Support	95	Sens S2 EVD 1 - Sensor Value Not Valid	151	IG Furnace 2 pressure - switch fault alarm
28	Space 1 CO2 - Sensor Value Not Valid	96	Sens S3 EVD 1 - Sensor Value Not Valid	152	IG Furnace 2 combust - fan proving alarm
29	Space Static Pressure - Sensor Value Not Valid	97	Sens S4 EVD 1 - Sensor Value Not Valid	153	IG Furnace 2 - Max retrys
30	Supply Duct Stat Press - Sensor Value Not Valid	98	EVD 1 EEPROM Damaged - Call Tech Support	154	IG Furnace 2 - High Limit Trip
31	Return Duct Stat Press - Sensor Value Not Valid	99	Incomplete Closing - EVD 1	155	IG Furnace - pCOe 2 Offline
32	Sup Fan AFMS - Sensor Value Not Valid	101	Emergency Closing - EVD 1	156	IG Furnace 2 IC fault - Check Furnace Wiring
33	Exh Fan AFMS - Sensor Value Not Valid	101	EVD 1 Battery -	157	Outside Air Greentrol - Offline or Flow Error
34	Outside Damper AFMS - Sensor Value Not Valid	102	FW Incompatibility - EVD 1	158	Exhaust Air Greentrol - Offline or Flow Error
35	Space Setpt Adj Slider - Sensor Value Not Valid	103	EVD 1 Config Error -	159	Supply Air Greentrol - Offline or Flow Error
36	Return CO2 - Sensor Value Not Valid	105	High Discharge Temp - First Inverter	160	OA Damper Fault - Not Econ and should be
37	Discharge Press Ckt A - Sensor Value Not Valid	106	Low Discharge Pressure - First Inverter	171	OA Damper Fault - Econ and shouldn't be
38	Discharge Press Ckt B - Sensor Value Not Valid	106	Low Discharge Pressure - First Inverter	171	OA Damper Fault - Econ and shouldn't be
39	Discharge Press Ckt A - Sensor Value Not Valid	107	High Suction Pressure - First Inverter	172	OAD Fault - Damper not Modulating
40	Suction Press Ckt A - Sensor Value Not Valid	108	Low Suction Pressure - First Inverter	173	OAD Fault - Excess Outdoor Air
41	Suction Press Ckt B - Sensor Value Not Valid	109	High Current - First Inverter	174	IG Furnace 1 - Combustion Fan Alarm
42	Discharge Temp Ckt A - Sensor Value Not Valid	110	High Pressure Ratio - First Inverte	175	IG Furnace 2 - Combustion Fan Alarm
43	Discharge Temp Ckt B - Sensor Value Not Valid	111	Low Pressure Ratio - First Inverter	176	Supply Fan - VFD Offline
44	Suction Temp Ckt A - Sensor Value Not Valid	112	Low Delta P - First Inverter	177	OA Damper Fault - Not Econ and should be
45	Suction Temp Ckt B - Sensor Value Not Valid	113	High Discharge Press - First Inverter	178	Return Fan - VFD Offline
46	Ckt A High Saturated - Discharge Temperature	114	Compressor Staging - Order Skipped	179	Energy Recovery - VFD Offline
47	Ckt B High Saturated - Discharge Temperature	115	Heat Pump Heating - Locked Out	180	Embedded EVD Error
48		116	EVD 1 Error - Unexpected Position	181	SF VFD Alarm - Check VFD

## Factory Controller Sequence of Operation

**FACTORY CONTROLLER:** Controller shall be provided with required sensors and programming for rooftop unit. Controller shall be factory programmed, mounted and tested. Controller shall have a LCD readout for changing set points and monitoring unit operation.

**UNIT START COMMAND (Unit will be enabled to start once a jumper is placed between R to G):**

- Factory mounted and wired outdoor air damper actuator is powered
- Return air damper actuator is powered.
- Exhaust fan starts after a (adj.) delay.
- Supply fan starts after a (adj.) delay.
- Tempering options and energy wheel option to function as described below.

**UNIT STOP COMMAND (OR DE-ENERGIZED):**

- Supply fan, exhaust fan, energy wheel and tempering options de-energized.
- Outdoor air damper actuator is spring return close.
- Return air damper is spring return close.

**OCCUPIED/UNOCCUPIED MODES:** Shall be based on a 7-day time clock internal to the controller. The schedule shall be set by the end user. When a user initiates an override input, the controller will switch from unoccupied to occupied mode. The controller will return to the scheduled occupied/unoccupied mode after the override time has expired. If internal time clock is disabled, a remote contact or a BMS can control the occupied/unoccupied mode.

**Occupied Mode:**

- Damper control per below.
- Energy wheel control per below.
- Exhaust fan ON.
- Supply fan ON.
- Heating per below.
- Cooling per below.

**Unoccupied Mode (Unit Off):** Unit remains off when in unoccupied mode.

- Supply fan OFF
- Exhaust fan OFF
- Tempering OFF
- Outdoor air damper closed.
- Return damper closed.

**MORNING WARMUP/COOL DOWN:** Prior to occupancy, the unit will run using the warmup or cool down sequence until the occupied set point is achieved. The heating or cooling mode must not be locked out and the space temperature is below or above set point by the unoccupied hysteresis (adj.) (This Sequence must be field configured.)

**SUPPLY BLOWER SEQUENCE:** The supply blower is provided with a factory mounted variable frequency drive. The supply blower speed will be controlled with the following sequence. Minimum supply fan turndown is 50% of the design maximum operation.

**Constant Volume-Adj. Setpoint:** The supply blower will operate at a constant speed set point (adj.) during operation.

**OUTDOOR AIR DAMPER CONTROL:** The outdoor air damper is factory mounted and wired with a non-modulating actuator. When the unit is enabled/occupied the outdoor air damper will open to 100%

**EXHAUST BLOWER SEQUENCE:** The exhaust blower is provided with a factory mounted variable frequency drive. The exhaust blower speed will be controlled with the following sequence.

**Constant Volume-Adj. Setpoint:** The exhaust blower will operate at a constant speed set point (adj.) during operation.

**COOLING SEQUENCE:** The cooling is controlled to maintain the supply temperature set point. The mechanical cooling will be locked out when the outside air is < 55 F (adj.).

**Air-Source Heat Pump:** The controller will provide a modulating signal for cooling. From 0-50%, the inverter scroll will be controlled to maintain discharge temperature. From 50-100% the second stage will be on in combination with the inverter scroll compressor to maintain the discharge temperature. The electronic expansion valve will modulate to maintain 10 F of superheat.

**Modulating Hot Gas Reheat Sequence:** During dehumidification the modulating HGRH is controlled to maintain the supply temperature set point.

**Modulating Hot Gas Reheat:** The controller will modulate the hot gas reheat valve with a 0-10 V signal to maintain the supply temperature set point (adj.).

**PRIMARY HEATING SEQUENCE:** The air-source heat pump is controlled to maintain the supply temperature set point. Heating will be locked out when the outside air is > 80 F (adj.). The air-source heat pump will be locked out when outside temperatures are < 10 F.

**Air-Source Heat Pump:** The controller will provide a modulating signal for heating. From 0-50%, the inverter scroll will be controlled to maintain discharge temperature. From 50-100% the second stage will be on in combination with the inverter scroll compressor to maintain the discharge temperature. The electronic expansion valve will modulate to maintain 10 F of superheat.

**SECONDARY HEATING SEQUENCE:** If the air-source heat pump cannot meet the supply temperature set point, the secondary heating source will activate and work in conjunction with the air-source heat pump.

**Electric Heater:** The controller will modulate an electric heater to maintain the supply temperature set point (adj.).

**TEMPERATURE CONTROL SEQUENCE:** The unit will maintain the supply air discharge setpoint per the following. Adjustable locally or by BMS.

**Supply Discharge Temperature Control:** The supply setpoint will be a constant temperature setpoint from the controller (adj.). Adjustable locally or by BMS.

**BUILDING FREEZE PROTECTION:** If the supply air temperature drops below 35 F (adj.) for 300s (adj.), the controller will de-energize the unit and activate the alarm output.

**TEMPERATURE PROTECTION:** The controller will enable the supply fan to modulate down to help the unit keep up with heating demand in the event of wheel failure or the unit operating outside design conditions. (This can be enabled under the manufacturer menu in the controller)

**ENERGY WHEEL FROST CONTROL:** Frost control for the energy wheel is enabled when frost is present on the wheel; based on the outside air temperature and the pressure drop across the wheel. If the outdoor air temperature is below 5 F adj. and the differential pressure across the wheel is about 1.5", adj. frost control will enable.

**Wheel VFD (Modulate Wheel):** When frosting is occurring, the VFD modulates the wheel down to a slow rotational speed to defrost wheel. Once either the pressure drop decreases below the pressure switch set point, or the outdoor air temperature increases about the temperature set point, the unit will resume normal operation.

**ECONOMIZER SEQUENCE:** When the application requires cooling, and the outdoor air conditions are suitable for free cooling, the controller will modulate the energy wheel speed to maintain the discharge temperature set point. If the energy wheel speed modulates to the economizer set point and the supply air temperature is not met, the controller will increase the call for cooling to meet the supply air temperature and could engage mechanical cooling.

**Temp./Enthalpy:** The economizer will be locked out when: the outdoor air is < 40 F DB (adj.) or > 75 F DB (adj.) or > 55 F dew point (adj.) ; the unit is operating in dehumidification mode; or there is a call for heating.

### ENERGY WHEEL SEQUENCE

**Modulate Wheel:** When economizer mode is enabled and there is a signal for cooling, the wheel VFD modulates wheel speed to maintain the supply air temperature set point.

**ALARMS INDICATION:** The controller will display alarms and have one digital output for remote indication of an alarm condition. Possible alarms include:

**Building Management System:** The controller will send all alarms to the BMS.

**Dirty Wheel Alarm:** The controller monitors pressure across the wheel and sends an alarm in the case of an increased pressure drop.

**Wheel Rotation Alarm:** The controller monitors wheel rotation, if the wheel does not rotate for a set period of time (adj.) an alarm will generate.

**Supply and Exhaust Air Alarm:** The controller monitors the proving switch on each blower and sends an alarm in the case of either blower proving switch not engaging.

**Temperature Sensor Alarm:** The controller sends an alarm in the case of a failed air temperature sensor.

**Humidity Sensor Alarm:** The controller sends an alarm in the case of a failed humidity sensor.

**ACCESSORIES:** The following accessories will be included with the unit to expand the functionality or usability of the controller.

**BMS Interfacing:** A BMS port or serial card is provided with the controller for field interfacing with a building management system. Each card is sent out with the default parameters, and the controls contractor must change the appropriate addresses to match the BMS settings.

**Phase and Brownout Protection:** Factory mounted and wired component which monitors the main power coming into the unit. If a phase drops out, or if the incoming voltage exceeds the acceptable range, the component will turn off the unit to help protect the electrical systems.

**Condensate Overflow Unit Shutdown:** Factory mounted condensate overflow switch wired to the unit controller. The controller monitors the condensate overflow switch. If the water level in the drain pan reaches a certain level, the unit will shutdown and send an alarm.

**Damper End Switch:** Damper end switched will be provided to ensure the supply and exhaust fans do not enable until the dampers are proven open.

## Warranty Statement for Dedicated Outdoor Air Systems (DOAS)

### Unit Warranty

Valent warrants the equipment to be free from defects in material and workmanship for a period of 18 months from ship date. Initial startup must be completed within six months of the shipment date, and a startup report must be submitted to Valent.

### Energy Wheel Warranty

The energy recovery wheel is warranted to be free from defects in material and workmanship for a period of 5 years from the shipment date. This warranty applies to all parts and components in the energy recovery cassettes with the exception of the motor.

### Compressor Extended Warranty

Valent warrants the refrigerant compressor(s) to be free from defects in material and workmanship for a period of 5.5 years from the shipment date.

### Warranty Notes

Any component which proves defective during the warranty period will be repaired or replaced at Valent's sole option when returned to our factory, transportation prepaid. All warranties do not include labor costs associated with troubleshooting, removal, or installation. Valent will not be liable for any consequential, punitive, or incidental damages resulting from use, repair, or operation of any Valent product. These warranties are exclusive and are in lieu of all other warranties, whether written, oral, or implied, including the warranty of merchantability and the warranty of fitness for a particular purpose. No person (including any agent or salesperson) has authority to expand Seller's obligation beyond the terms of this warranty, or to state that the performance of the product is other than that published by Seller.

*As a result of our commitment to continuous improvement, Valent reserves the right to change specifications without notice.*

### GKD Roof Curb

Model: GKD-45.9/173.9-G14

Curb Height (in.)	Curb Length (in.)	Curb Width (in.)	Material	Finish Type	Duct Adapter	Curb Weight (lb)
14	173.9	45.9	Galvanized	Galvanized	Yes	269

Standard Construction Features:
All dimensions shown are actual and in units of in.'s
If unit is selected with side or end discharge/return, there will not be bottom connections supplied with the curb.
14 gauge galvanized steel (perimeter channels).
14 gauge galvanized steel (interior channels).
Ships knocked down for field assembly.
Curb insulation to be provided by others.

Curb Detail

Top View of Curb

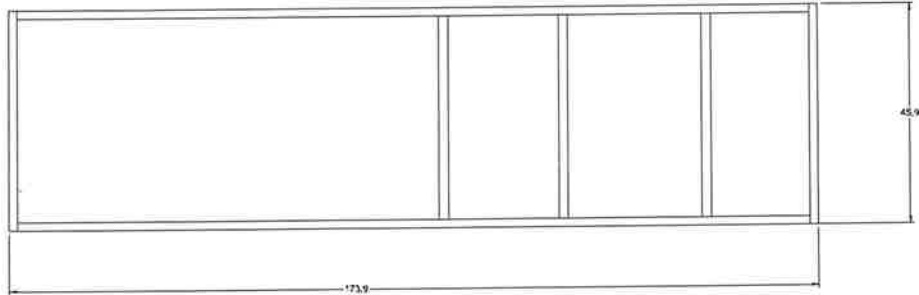

Cross-Section View of Unit on Curb

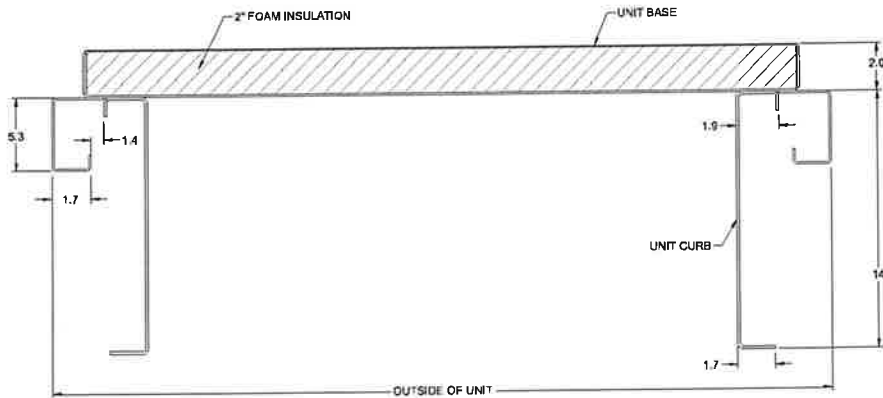

# VXE-112-36D-CW-G-D1

## Unit Performance

Design Conditions						
Elevation (ft)	Summer		Winter DB (F)	Supply (CFM)	Outdoor Air (CFM)	Exhaust Air (CFM)
	DB (F)	WB (F)				
180	91.0	73.0	0.0	3,200	3,200	3,200

Unit Specifications						
Qty	Weight (lb)	Cooling Type	Heating Type	Unit Installation	Unit ETL Listing	Furnace ETL Listing
1	2,849 (+/- 5%)	Chilled Water	Indirect Gas	Outdoor	UL/cUL 1995/60335-2-40	ANSI Z83.8 / CSA 2.6

Configuration			
Outdoor Air		Exhaust Air	
Intake	Discharge	Intake	Discharge
End	Side	Access Side	Side

Energy Recovery Performance									
Design Condition	Temperature (F)								Capacity Reduction (BTU/h)
	Outdoor Air		Supply Air		Return Air		Exhaust Air		
	DB	WB	DB	WB	DB	WB/RH	DB	WB	
Summer	91.0	73.0	81.0	67.0	75.0	62.5/50	85.0	69.2	73,440.0
Winter	0.0	-1.5	41.6	35.9	72.0	55.8/35	27.4	26.8	143,770.0

Cooling Specifications										
Type	Fluid Type		Flow Rate (GPM)	Fluid PD (ft wg)	Capacity (MBH)		Fluid Conditions		Performance (DB/WB)	
	Type	%			Total	Sensible	EWT (F)	LWT (F)	EAT (F)	LAT (F)
Chilled Water	Water	100	30.5	5	153.1	105.1	45.0	55.0	81.0 / 67.0	51.1 / 51.1

Heating Specifications									
Type	Gas Type	Input (MBH)	Output (MBH)	Temperature Rise		Turndown	Performance		
				Min (F)	Max (F)		EAT (F)	LAT (F)	
Indirect Gas	Natural	200.0	162.0	3.0	47.0	16:1	41.6	88.4	

Air Performance								
Type	Total Volume (CFM)	External SP (in. wg)	Total SP (in. wg)	FRPM	Fan			
					Qty	Type	Drive-Type	
Supply	3,200	1.5	3.998	2106	1	Plenum	Direct	
Exhaust	3,200	1.25	3.09	2012	1	Plenum	Direct	

Motor Specifications						
Motor	Qty	Operating Power (hp)	Size (hp)	Enclosure	Efficiency	RPM
Supply	1	3.21	5	ODP	PE	1750
Exhaust	1	2.82	5	ODP	PE	1750

Electrical Specifications					
Power Supply	Rating (V/C/P)	MCA (A)	MOP (A)	FLA (A)	Fan Power (W/CFM)*
Unit	<del>208/60/3</del>	30.4	45.0	31.5	1.405

\*Fan Power (W/CFM) = (Supply BHP + Exhaust BHP) / Supply CFM  
 480/60/3

20 14.2

### Construction Features And Accessories

Unit	
Unit Installation - Outdoor	Std
Unit Construction - Double Wall	Std
Insulation - 2 inch 2.4# R13 foam	Std
Corrosion Resistant Fasteners	Std
Hinged Access	Std
Factory Wired Non-Fused Disconnect Switch	X
Direct Drive Plenum Blower & Motor Assemblies	Std
Factory Wired VFDs	Std
Unit Finish - Permatector, Concrete Gray (RAL 7023)	X
Stainless Steel Condensate Drain Pan and Connection	Std
Condensate Drain Trap	Std
Energy Recovery Device - Polymer Wheel w/ Silica Gel Desiccant	Std
Controls	
Unit Controls - Heat-Cool Only Control	Std
Internally Mounted Control Center with 24 VAC control transformer(s)	Std
BMS Protocol - BACNetMSTP	X
BMS Monitoring Points	
Supply Fan Control - 0-10VDC By Others	X
Exhaust Fan Control - 0-10VDC By Others	X
Economizer Control	X
Exhaust Fan Only Power	
Web-Based User Interface	
Energy Wheel Economizer Control - VFD Signal By Others	X
Energy Wheel Rotation Sensor	Std
Damper Control - 0-10VDC By Others	X
Unoccupied Recirc Mode	
Control Accessories	
Remote Display	
Dirty Filter Sensor(s)	
Airflow Monitor	
Room Thermostat	
Phase/Brownout Protection	X
Economizer Fault Detection Diagnostics	

Accessories	
Frost Control - VFD Signal By Others	X
Outdoor Air Damper - Low Leakage	X
Return Air Damper - Low Leakage	X
Roof Curb - GKD - 45.9/173.9-G14	X
Supply Air Filters - 2" Merv 8 And 2" Merv 13, 8-20x20x2	X
Service Outlet - Shipped loose and powered by others	X
Piping Vestibule	
Service Lights	
Condensate Overflow Switch	X
Spare Filters - Both, Qty: 1 set(s)	X
Exhaust Discharge Gravity Backdraft Damper	Std
ElectroFin Coil Coating	
Motor Shaft Grounding	X
Return Air Filters - 2" Merv 8, 2-20x25x2	Std
Outdoor Air Filters - 2" Merv 8, 2-20x25x2	Std
Furnace Control - 16:1 Modulating	X
Spare Energy Wheel Belt	
Spare Energy Wheel Segments	
UV Lights	
Bipolar Ionization	
Smoke Detector(s)	
Barometric Relief Damper	
Energy Wheel Bypass Damper	
Power Venting	Std
Warranty Options	
Unit Warranty - 18 Months (Std.)	Std
Energy Wheel Warranty - 5 Yrs Less Motor	Std
Furnace HX Warranty - 25 Yrs.	Std

Standard Option	Std
Not Included	
Included	X

#### Notes

Outdoor Air Damper supplied is low leakage, motorized VCD-23 (leakage rate of 3 CFM / ft<sup>2</sup> @ 1 in. wg), Class 1A  
 Return Air Damper supplied is low leakage, motorized VCD-23 (leakage rate of 3 CFM / ft<sup>2</sup> @ 1 in. wg), Class 1A

### Supply Fan Charts And Performance

Supply Fan Performance									
Total Volume (CFM)	External SP (in. wg)	Total SP (in. wg)	RPM	Operating Power (hp)	Motor		Fan		
					Qty	Size (hp)	Qty	Type	Drive-Type
3,200	1.5	3.998	2106	3.21	1	5	1	Plenum	Direct

Pressure Drop (in. wg)							
Weatherhood	Filter	Damper	Cooling	Heating	External	Energy Wheel	Total
0.08	0.304	0.04	0.444	0.354	1.5	1.28	3.998

Sound Performance in Accordance with AMCA										
Sound Power by Octave Band								Lwa	dBA	Sones
62.5	125	250	500	1000	2000	4000	8000			
77	82	85	77	71	67	74	64	81	69	18

\*Energy Wheel pressure drop shown in above table also accounts for pressure drop across MERV8 OA filter

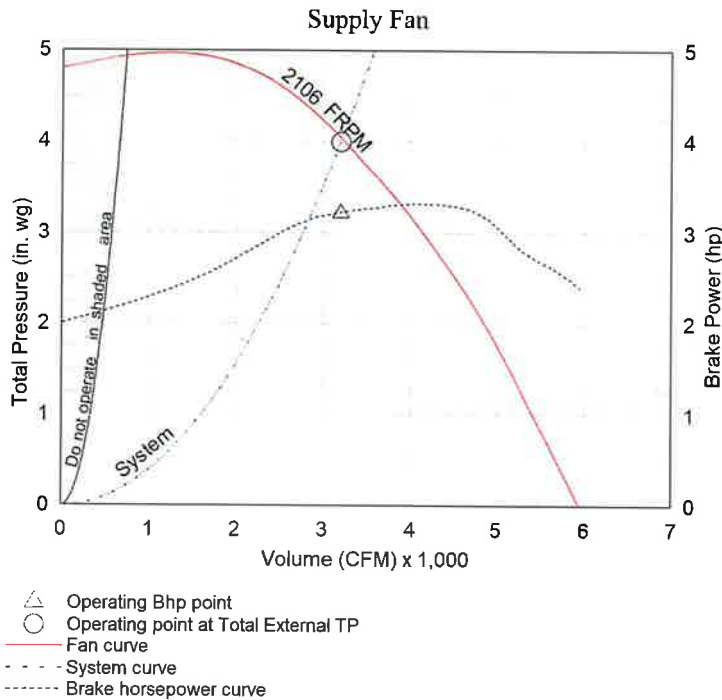

### Exhaust Fan Charts And Performance

Exhaust Fan Performance									
Total Volume (CFM)	External SP (in. wg)	Total SP (in. wg)	RPM	Operating Power (hp)	Motor		Fan		
					Qty	Size (hp)	Qty	Type	Drive-Type
3,200	1.25	3.09	2012	2.82	1	5	1	Plenum	Direct

Pressure Drop (in. wg)							
Weatherhood	Filter	Damper	Cooling	Heating	External	Energy Wheel	Total
0.13	-	-	-	-	1.25	1.71	3.09

Sound Performance in Accordance with AMCA										
Sound Power by Octave Band								Lwa	dBA	Sones
62.5	125	250	500	1000	2000	4000	8000			
81	72	80	73	69	67	67	61	77	65	14

\*Energy Wheel pressure drop shown in above table also accounts for pressure drop across MERV8 return air filter

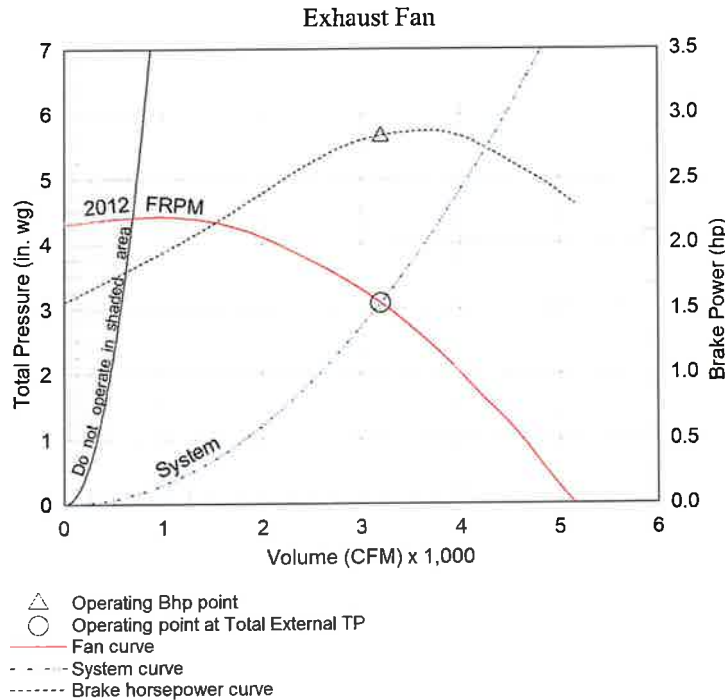

### Radiated Sound

#### Position C

Dimensional Overview

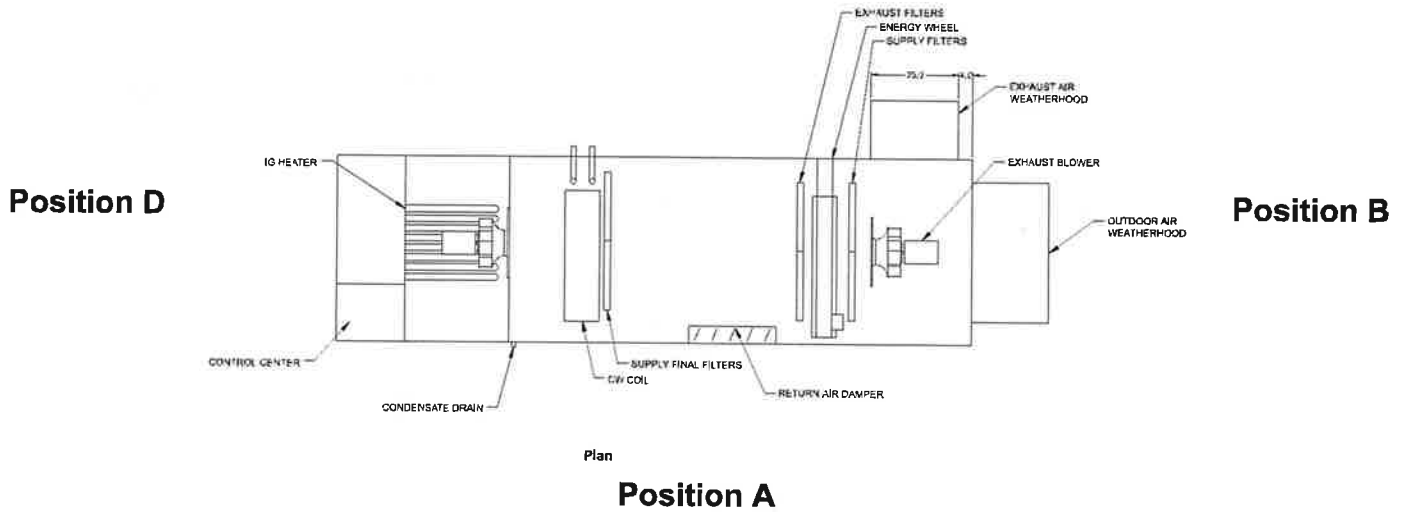

Supply Air Flow Nominal

#### Radiated Sound Levels

Plane	Octave Bands (Lw)								Plane Lw	Plane LwA
	1	2	3	4	5	6	7	8		
A	73	86	81	79	77	73	69	63	89	92
B	71	79	77	71	69	64	63	55	82	75
C	79	76	69	66	64	59	53	46	81	69
D	74	77	72	72	69	62	58	51	81	74
E	77	84	80	76	76	70	66	60	87	80
<b>Total</b>	83	89	85	82	81	76	72	65	92	85

#### AMCA 320-07 - Laboratory Methods of Sound Testing of Fans Using Sound Intensity

Tests conducted in accordance with this standard.

Free field measurement plane created 1 foot from unit on all sides and top.

Sound Intensity measured in Watts/m<sup>2</sup>.

Sound data converted to Sound Power (Lw) for the chart above.

A-Weighted Sound Power was determined using AMCA Standard 301-90 Clause 9.1.

Plane E sound data was measured above the top plane of the unit.

### Cooling Performance

Cooling Specifications										
Type	Fluid Type		Flow Rate (GPM)	Fluid PD (ft wg)	Capacity (MBH)		Fluid Conditions		Performance (DB/WB)	
	Type	%			Total	Sensible	EWT (F)	LWT (F)	EAT (F)	LAT (F)
Chilled Water	Water	100	30.5	5	153.1	105.1	45.0	55.0	81.0 / 67.0	51.1 / 51.1

Coil Information					
CW Coil Model	Fins Per Inch	Rows Deep	Face Vel. (ft/min)	Coil PD (in. wg)	Connection Size (in.)
CW58S06H10-42x37-RH	10	6	297	0.444	1.5

Unit Details
Coil control valves must be field provided by others
Copper tube, aluminum fin coil construction
Coil freeze protection is to be provided by others
Stainless steel double sloped drain pan

### Heating Performance

Heating Specifications								
Type	Gas Type	Input (MBH)	Output (MBH)	Temperature Rise		Turndown	Performance	
				Min (F)	Max (F)		EAT (F)	LAT (F)
Indirect Gas	Natural	200.0	162.0	3.0	47.0	16:1	41.6	88.4

Unit Details
ANSI standard Z83.8 and CSA 2.6
High Thermal efficiency
Direct spark ignition
3/4" Gas Connection
At least 6 in. wg of natural gas pressure (14 in. wg for LP) is required at the units gas connection in order to achieve maximum performance
Power Venting
24 Volt Control Power
Stainless Steel heat exchange tubes
Unit controller maximum allowable supply discharge air set point is 100F (37.8C)
Discharge temperature assumes proper energy wheel operation and maintenance.

### Energy Recovery Summer Performance

Outdoor Air		Supply Air	
Dry Bulb (F)	91.0	Dry Bulb (F)	81.0
Wet Bulb (F)	73.0	Wet Bulb (F)	67.0
Specific Humidity (gr/lb)	94	Specific Humidity (gr/lb)	77
Enthalpy (BTU/lb)	36.7	Enthalpy (BTU/lb)	31.6
Exhaust Air		Return Air	
Dry Bulb (F)	85.0	Dry Bulb (F)	75.0
Wet Bulb (F)	69.2	Rel. Humidity (%)	50
Specific Humidity (gr/lb)	82	Specific Humidity (gr/lb)	65
Enthalpy (BTU/lb)	33.2	Enthalpy (BTU/lb)	28.2

Design Air Flow Conditions			
OA Volume (CFM)	ASHRAE 90.1 OA Enthalpy Recovery Ratio	EA Volume (CFM)	EA Wheel Effectiveness
3,200	60.4	3,200	59.2

Outdoor Air Cooling Reduction				
OA Load w/o Energy Recovery		OA Load with Energy Recovery		Equipment Reduction (tons)
(BTU/h)	(tons)	(BTU/h)	(tons)	
122,400.0	10.20	48,960.0	4.08	6.12

### Summer Conditions

- 1 = Outdoor Air Design
- 2 = Energy Wheel
- 3 = Chilled Water Coil
- 4 = Exhaust Air Entering Wheel

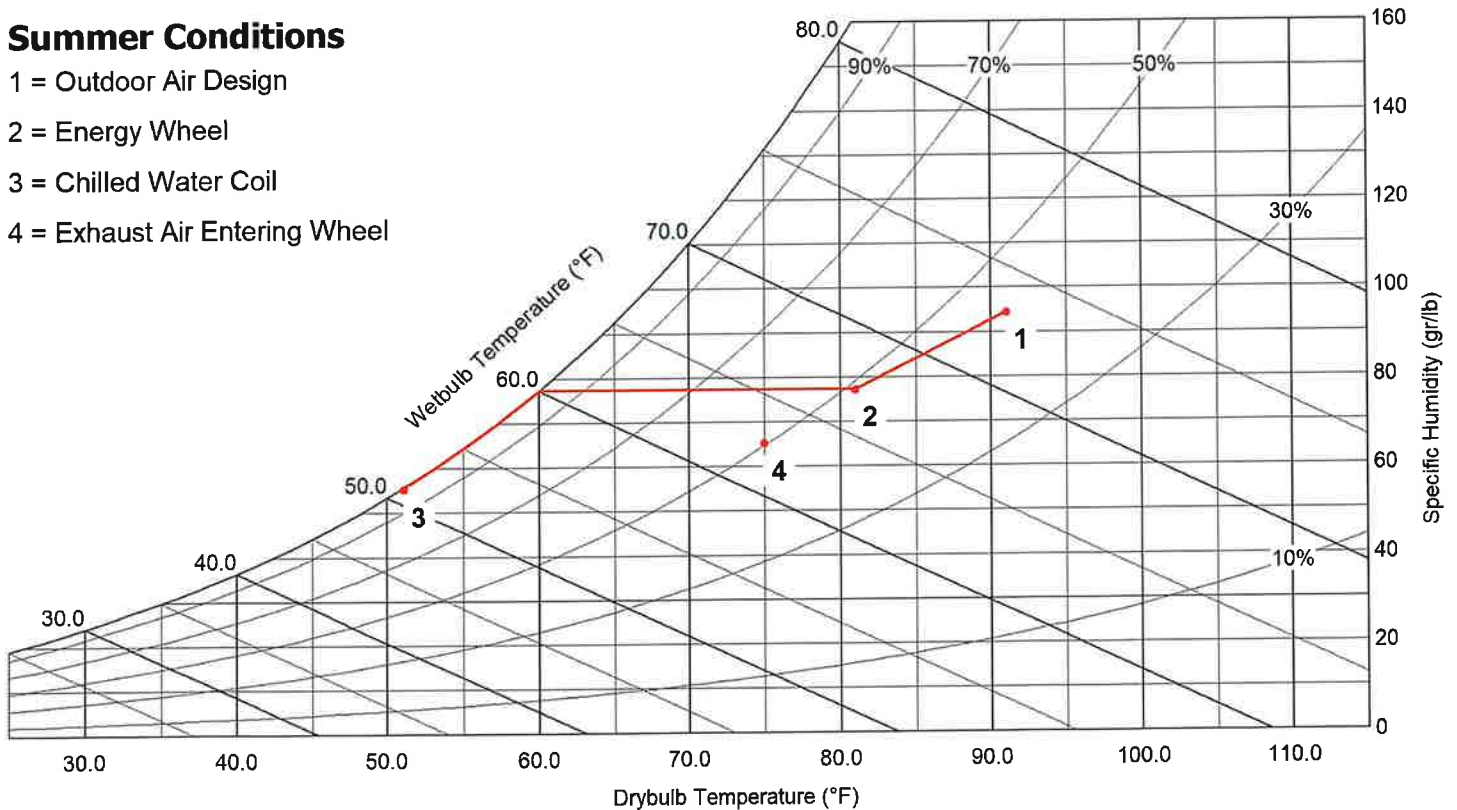

### Energy Recovery Winter Performance w/out Preheater

Outdoor Air		Supply Air	
Dry Bulb (F)	0.0	Dry Bulb (F)	41.6
Wet Bulb (F)	-1.5	Wet Bulb (F)	35.9
Specific Humidity (gr/lb)	3	Specific Humidity (gr/lb)	22
Enthalpy (BTU/lb)	0.4	Enthalpy (BTU/lb)	13.4
Exhaust Air		Return Air	
Dry Bulb (F)	27.4	Dry Bulb (F)	72.0
Wet Bulb (F)	26.8	Rel. Humidity (%)	35
Specific Humidity (gr/lb)	20	Specific Humidity (gr/lb)	41
Enthalpy (BTU/lb)	9.7	Enthalpy (BTU/lb)	23.7

Design Air Flow Conditions			
OA Volume (CFM)	ASHRAE 90.1 OA Enthalpy Recovery Ratio	EA Volume (CFM)	EA Wheel Effectiveness
3,200	55.8	3,200	59.3

Outdoor Air Heating Reduction			
OA Load w/o Energy Recovery (BTU/h)	OA Load with Energy Recovery (BTU/h)	Equipment Reduction (BTU/h)	Sensible Effectiveness (%)
248,832.0	105,062.0	143,770.0	61.5

### Winter Conditions

- 1 = Outdoor Air Design
- 2 = Energy Wheel
- 3 = Indirect Gas Heater
- 4 = Exhaust Air Entering Wheel

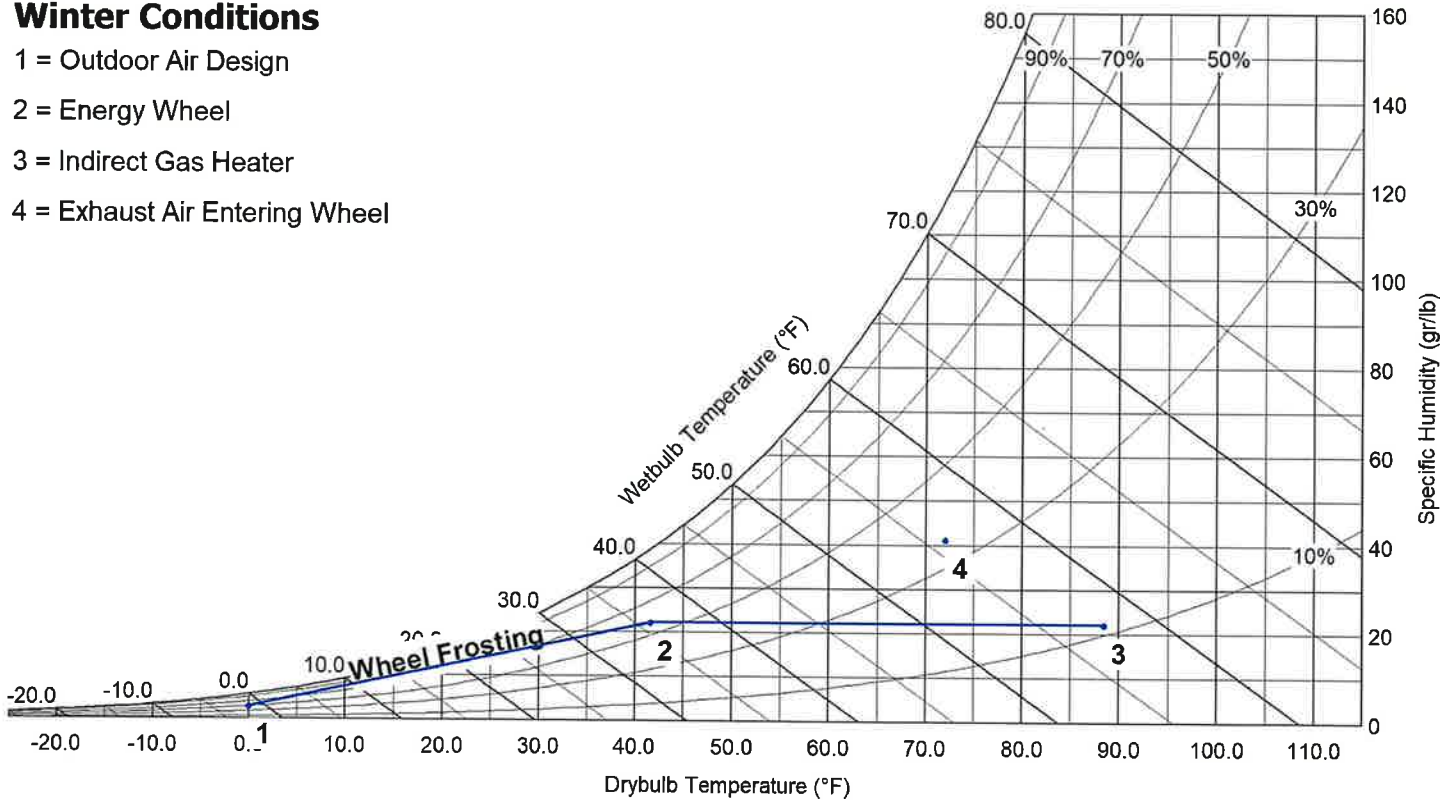

### AHRI Performance Ratings

#### Energy Recovery Performance Rating in accordance with AHRI Standard 1060 (I-P)

Rated Airflow (SCFM)		Net Supply Airflow (SCFM)	EATR (%)	OACF	Pressure Drop (in. wg)		Purge Angle (degrees)
Leaving Supply	Entering Exhaust				Supply	Exhaust	
3245	3245	3200	1.4	1.05	1.00	0.99	0

#### Thermal Effectiveness Ratings

Enthalpy Recovery		Sensible Effectiveness		Latent Effectiveness		Total Effectiveness	
Summer	Winter	Summer	Winter	Summer	Winter	Summer	Winter
60.4	55.8	61.9	61.5	56.7	53.9	59.2	59.3

#### Note(s)

##### Summer Design Conditions:

Certified in accordance with the AHRI ERV Certification Program, which is based on AHRI Standard 1060. Certified units may be found in the AHRI Directory at [www.ahridirectory.org](http://www.ahridirectory.org).



##### Winter Design Conditions:

Application Rating is outside the scope of the AHRI ERV certification Program but is rated in accordance with AHRI Standard 1060.

### Isometric Drawings

#### Component Layout

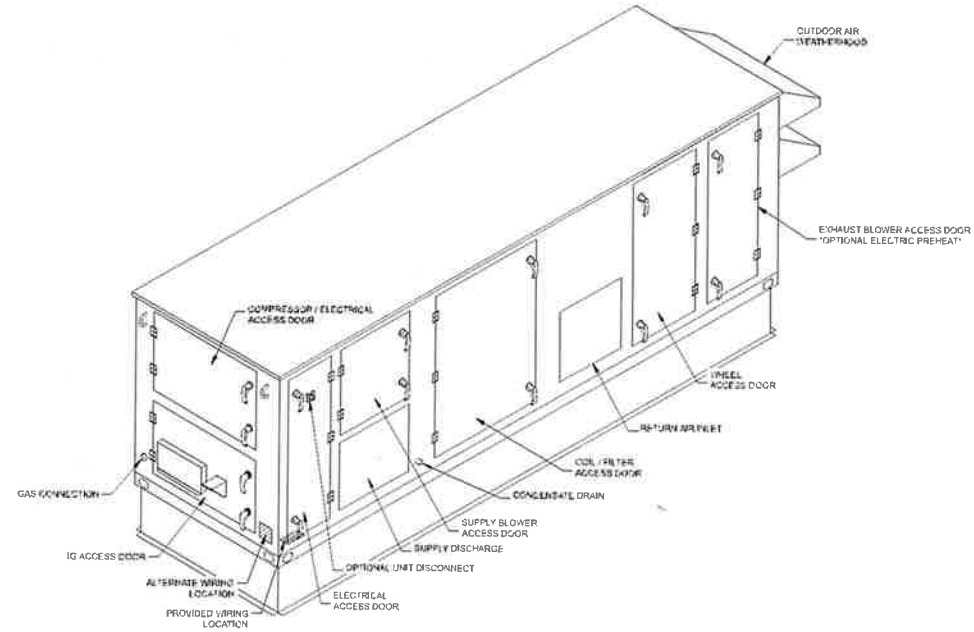

Back Right Isometric

#### Service Clearances

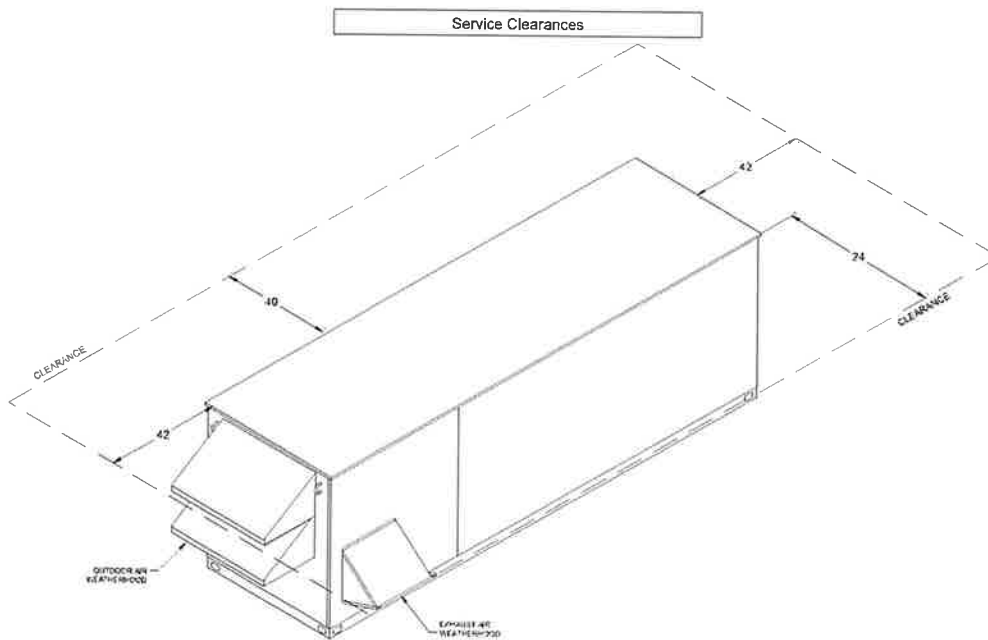

Front Left Isometric

# Overview Drawings

## Dimensional Overview

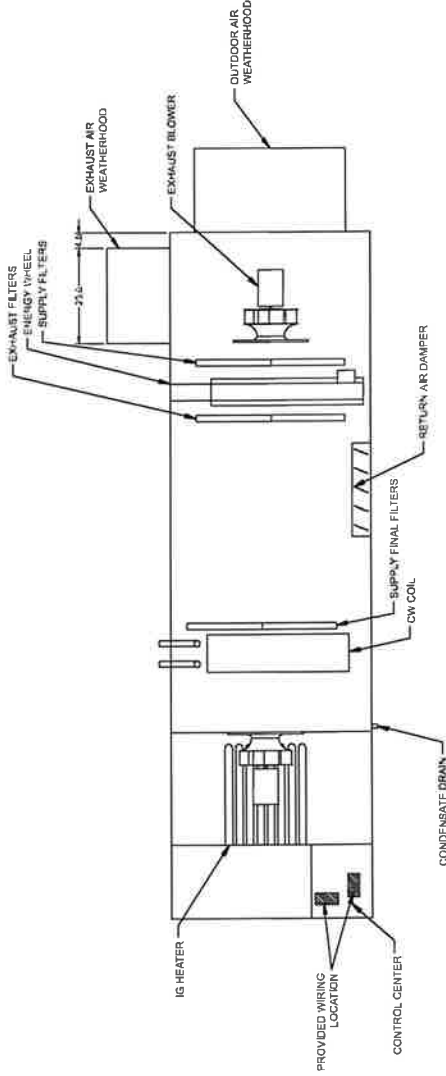

## Electrical Connections

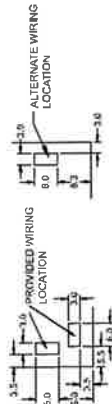

103

## Plan

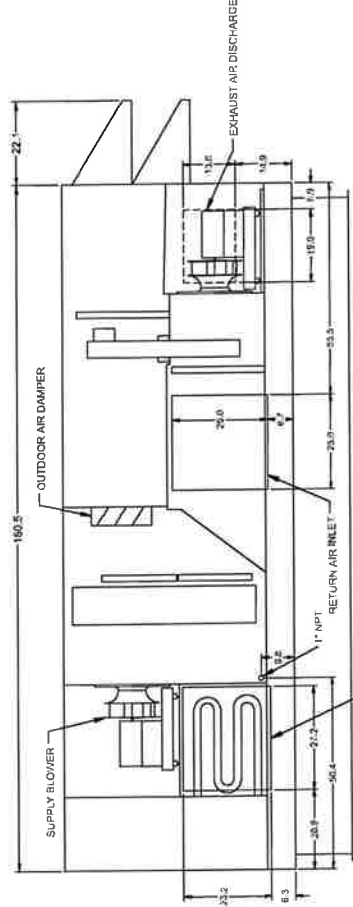

## Elevation

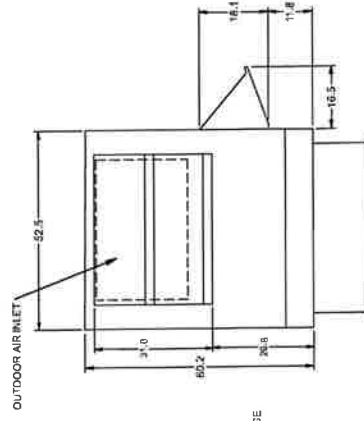

## Right End

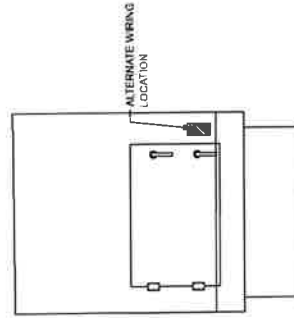

## Left End

### Unit Corner Weights

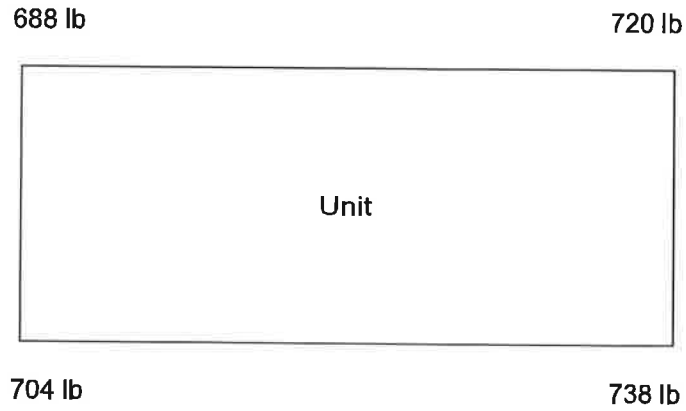

**Note**

Estimated corner weights are shown looking down on unit and the outside air intake will be on the right. Weights are applied at the base of the unit. Images not drawn to scale.

### Wiring Diagram

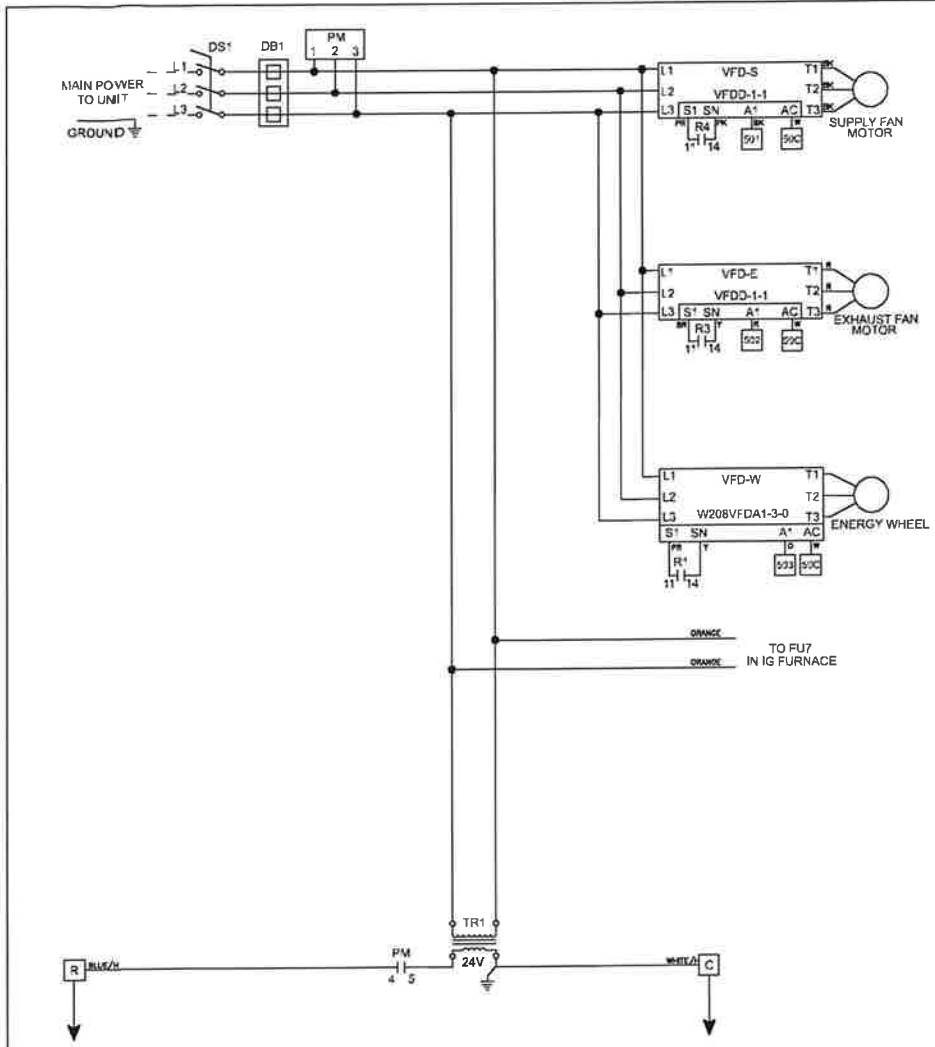



Wiring Diagram Code:  
**V22E1G1GF02A44X00CX02H0000BH29**

**CAUTION**  
 UNIT SHALL BE GROUNDED IN ACCORDANCE WITH N.E.C.  
 POWER MUST BE OFF WHILE SERVICING.

**NOTES**  
 USE COPPER CONDUCTORS ONLY  
 80° C FOR TERMINALS RATED LESS THAN 100 AMPS.  
 75° C FOR TERMINALS RATED 100 AMPS OR MORE.  
 FIELD CONTROL WIRING RESISTANCE SHOULD  
 NOT EXCEED 0.75 OHM.  
 FIELD WIRED - - - - -  
 FACTORY SUPPLIED AND WIRED \_\_\_\_\_

**WIRE COLOR CODE**

BK	BLACK	BL	BLUE	BR	BROWN
GY	GRAY	LT BL	LIGHT BLUE	O	ORANGE
PK	PINK	PR	PURPLE	R	RED
W	WHITE	Y	YELLOW		

**LEGEND**

DB#	POWER DISTRIBUTION BLOCK
DS	DISCONNECT SWITCH
PM	PHASE VOLTAGE MONITOR
R1	ENERGY WHEEL CONTACTOR
R3	EXHAUST BLOWER VFD RELAY
R4	SUPPLY BLOWER VFD RELAY
TR#	TRANSFORMER
VFD	VARIABLE FREQUENCY DRIVE

Wiring Template: H2B    DOC NUMBER: 2888496    REV: 6



### INDIRECT GAS WIRING DIAGRAM FURNACE 1 - HTD MODULATING

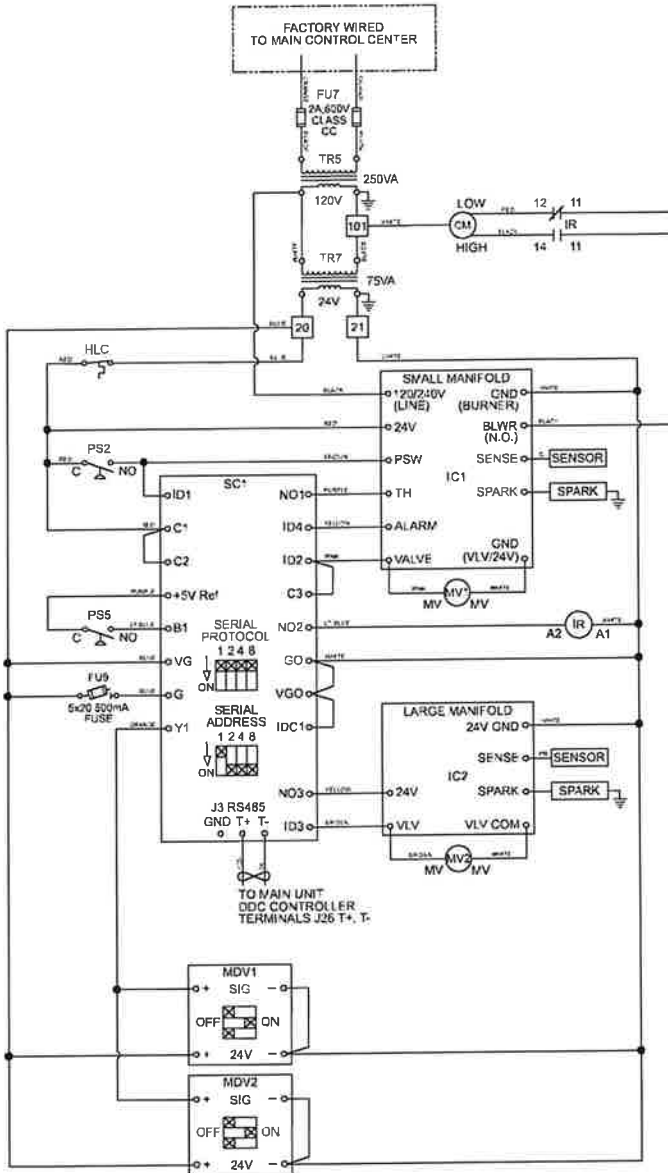

Wiring Diagram Code  
**V4N51X1RX0010GS22**

**CAUTION**  
 UNIT SHALL BE GROUNDED IN ACCORDANCE WITH N.E.C.  
 POWER MUST BE OFF WHILE SERVICING.

**NOTES**  
 USE COPPER CONDUCTORS ONLY.  
 60° C FOR TERMINALS RATED LESS THAN 100 AMP.  
 75° C FOR TERMINALS RATED 100 AMPS OR MORE.  
 FIELD CONTROL WIRING RESISTANCE SHOULD  
 NOT EXCEED 0.75 OHM.  
 FIELD WIRE - - - -  
 FACTORY SUPPLIED AND WIRED - - - -

**NOTE 1**  
 MODBUS COMMUNICATION WIRING. DASHY CHAIN TO  
 ALL MODBUS DEVICES.

**WIRE COLOR CODE**

BK	BLACK	BL	BLUE	BR	BROWN
GY	GRAY	LT BL	LIGHT BLUE	O	ORANGE
PK	PINK	PR	PURPLE	R	RED
W	WHITE	Y	YELLOW		

**LEGEND**

CM	COMBUSTION BLOWER MOTOR
FU#	FUSE(S)
HLC	HIGH TEMPERATURE LIMIT CONTROL
IC1	IGNITION CONTROL - SMALL MANIFOLD
IC2	IGNITION CONTROL - LARGE MANIFOLD
IR	INDUCTION RELAY
MDV1	MODULATING VALVE - SMALL MANIFOLD
MDV2	MODULATING VALVE - LARGE MANIFOLD
NV1	MAIN GAS VALVE - SMALL MANIFOLD
NV2	MAIN GAS VALVE - LARGE MANIFOLD
PS2	COMBUSTION AIR PROOVING SWITCH
PS5	HIGH SPEED PRESSURE SWITCH
SC1	STAGE CONTROLLER
TR#	TRANSFORMER(S)

Wiring Template: S22 DOC NUMBER 2886496 REV 6

## Heat-Cool Only Controls - Sequence of Operation

### 1. Third-Party Controls Responsibilities and Limitations

The following information in this section are guidelines for the third-party controls contractor to follow when controlling a unit with Heat-Cool Only controls:

#### 1.1 Airflow

Maintaining the proper airflow through the unit is the responsibility of the third-party.

##### A. Dampers

Ensure damper end switch, when installed, proves the damper position for airflow through the unit prior to starting the supply fan. (100% OA units)

- i. Outside Air Damper
- ii. Return Air Damper

##### B. Supply Fan Modulation

Proper fan modulation is the responsibility of the third-party. Enable and modulation of the supply fan within the following guidelines:

- i. Compressor Operation
  - Fan turn down limited to 50% of the designed airflow.
- ii. Electric Heat
  - Fan turndown limited to the requirements from the electric heater manufacturer.
- iii. Gas Furnace Heat
  - All gas furnaces must be limited to the greater of the following:
    - o minimum airflow in CFM; OR
    - o 50% of design airflow.

##### C. Exhaust Fan Modulation

Enable and modulation of the exhaust fan necessary to achieve the building requirements.

#### 1.2 Energy Recovery

Controlling the energy recovery equipment is the responsibility of the third-party.

A. Enable of Energy recovery device and modulation signal, if installed.

B. Defrost of device located in the outside air stream.

All units with energy recovery options must provide a defrost sequence for the energy recovery section.

##### i. Energy Wheel

- Provide a difference pressure switch or transducer installed across the energy wheel; AND
- Maintain less than 1.5"wc when Outside Air Temp less than 10 F.

##### ii. Energy Core

- Provide an exhaust air temperature sensor; AND
- Maintain the exhaust air temperature  $\geq 30$  F.

##### i. Energy Wheel

- Provide an exhaust air temperature sensor; AND
- Maintain the exhaust air temperature  $\geq 25$  F.

iii. Pre-heat device, when installed, for energy recovery defrost.

- Outside Air Damper  $\geq 30\%$  open; AND
- Supply Fan enabled; AND
- Outdoor Air Temp less than 10 F.

*Note: Please see manufacturer's information for suggested minimum cfm for pre-heat.*

### 1.3 Supply Air Temperature Control

Supply Air Temperature must be monitored and maintained by the third-party.

#### A. Supply Air Temperature Setpoint

- i. A 2-10VDC analog input will be utilized by the third-party for setpoint control.
- ii. Setpoint range between 50.0°F and 95.0°F for all modes of operation.  
*Note: A minimum setpoint of 60.0°F is advised in heating mode of a heat pump.*

#### B. Supply Air Temperature Limits

The third-party must follow the supply air temp limits below.

- i. Minimum Low Supply Temp Limit
  - Supply Air Temperature less than 35 F.
  - Cooling will shutdown and the unit will be disabled.
- ii. Maximum High Supply Temp Limit
  - Supply Air Temperature > 120 F.
  - Heating will shutdown and the unit will be disabled.

### 1.4 Cooling and Dehumidification

Refrigeration control is requested by the third-party via two 2-10VDC inputs:

#### A. Cooling Mode

- Remote Enable Input: Closed
- Cooling/Dehumidification Input: Open
- Cooling/Heating Input: Open
- Cooling Coil Setpoint Request: 50 F - 75 F scaled from 2-10VDC (Compressor Staging)

#### B. Dehumidification Mode

- Remote Enable Input: Closed
- Cooling/Dehumidification Input: Closed
- Cooling/Heating Input: Open
- Supply Air Setpoint Request: 50 F - 95 F scaled from 2-10VDC (HGRH Valve Modulation)
- Cooling Coil Setpoint Request: 50 F - 75 F scaled from 2-10VDC (Compressor Staging)

### 1.5 Heating

Heating device control is requested by the third-party via a single 2-10VDC input. This input will control any heating devices installed in the unit.

#### A. Heating Mode

*(IG Furnace, Electric Heat, Hot Water, Heat Pump Heating)*

- Remote Enable Input: Closed
  - Cooling/Dehumidification Input: Open
  - Cooling/Heating Input: Closed
  - Supply Air Setpoint Request: 50 F - 95 F scaled from 2-10VDC
- Note: A minimum setpoint of 60.0 F is advised in heating mode of a heat pump.*

## 2. Controls Availability

The following sequence is logic in the Heat-Cool Only Controller installed in the unit.

### 2.1 Unit Availability

The unit is available for operation when the following conditions are met:

- A. Heat-Cool Only system alarms are not active.
- B. Shutdown Input is closed.
- C. Remote Start Input is closed.
- D. Supply fan status indicates that the fan is running.
- E. Outside Air Temperature sensor is reading a normal temperature.
- F. Coil Leaving Air Temperature sensor is reading a normal temperature.
- G. Supply Air Temperature sensor is reading a normal temperature.

## 2.2 Cooling Availability

The unit is available to operate in cooling mode when all the Unit Availability conditions, and the following conditions are met:

- A. Outside Air Temp > Cooling Ambient Lockout.
- B. Coil Leaving Air Temp > Cold Coil Low Limit Setpoint.
  - If the coil leaving temp falls below 42.0 F, the compressors are not available to stage on until the cooling coil temp reaches 46.0 F.
- C. Cooling/Heating Control Mode is open for cooling mode (third-party input).
- D. Refrigeration alarms are not active.

## 2.3 Heating Availability

The unit is available to operate in heating mode when all the Unit Availability conditions, and the following conditions are met:

- A. Outside Air Temp less than Heating Ambient Lockout.
- B. Cooling/Heating Control Mode is closed for Heating Mode (third-party input).
- C. Heat device alarms are not active.
- D. Heat Pump Heating – Outside Air Temp > ASHP Low Ambient Lockout for ASHP.

## 3. Cooling Sequence

### 3.1 Cooling Control

The heat-cool only controller performs the following functions for compressor control.

- A. The compressors stage and modulate to maintain the cooling coil temperature setpoint.

- B. Modulating Inverter Scroll Compressor

If the unit is equipped with an inverter scroll compressor, the following control will also apply:

- Envelope Control: The Heat-Cool Only controller will monitor temperatures and pressures in the circuit and compare them to the compressor's operating envelope to ensure that the compressor is within safe operating conditions.
- Superheat Control: An Electronic Expansion Valve (ExV) and Electronic Valve Driver (EVD) will be utilized in the modulating circuit. The EVD will control the position of the ExV based on the Suction Superheat to maintain a setpoint of 10 F.

### 3.2 Dehumidification Control

Dehumidification mode is possible on units equipped with Hot Gas Reheat.

- A. Enable Dehumidification

The Cooling/Dehumidification input is closed to initiate dehumidification mode, the following will occur:

- The hot gas reheat valve will modulate to maintain the supply air temperature setpoint.

- The compressors stage and modulate to maintain the cooling coil temperature setpoint.

#### B. Disable Dehumidification

The Cooling/Dehumidification input is open to initiate cooling mode, the following will occur:

- The HGRH valve modulates to the closed position when a compressor in the HGRH circuit is operating.
- The compressors stage and modulate to maintain the cooling coil temperature setpoint.

### 3.3 Pressure Control

Pressure control maintains a consistent condensing temperature in cooling and dehumidification modes by modulating coil fans to meet the pressure control setpoint.

## 4. Heating Sequence

### 4.1 Heat Control

The heat-cool only controller performs the following functions for control of gas furnaces, electric heat, or hot water devices installed in the unit.

A. Modulates the heating device to maintain the supply air temperature setpoint.

### 4.2 Heat Pump Heating

A. The compressors stage and modulate to maintain the supply air temperature setpoint.

B. Modulating Inverter Scroll Compressor

If the unit is equipped with an inverter scroll compressor, the following control will also apply:

- **Envelope Control:** The main controller will monitor temperatures and pressures in the circuit and compare them to the compressor's operating envelope to ensure that the compressor is within safe operating conditions.
- **Superheat Control:** An Electronic Expansion Valve (ExV) and Electronic Valve Driver (EVD) will be utilized in the modulating circuit. The EVD will control the position of the ExV based on the Suction Superheat to maintain a setpoint of 10 F.

C. Pressure Control

Pressure control maintains a consistent coil temperature in heating mode by modulating coil fans to meet the pressure control setpoint.

D. Secondary Heat

A secondary heating device may be installed in the unit. This device may be electric heat, gas furnace, or a hot water coil.

- **Backup**  
Secondary heat only operates when heat pump heating is not available.
- **Supplemental**  
Secondary heat will operate simultaneously with heat pump heating when the compressors are not producing enough heat to stay within 2 F of setpoint.

E. Outside Coil Defrost - ASHP

An Air-Source Heat Pump (ASHP) periodically initiates a defrost cycle of the outside coil to remove the accumulation of frost build-up when operating in heating mode.

- **Supplemental Heat**

If supplemental heat is installed in the unit, that heating device will maintain the Supply Air Temperature Setpoint.

- **Backup Heat**  
If backup heat is installed in the unit, that heating device will NOT start during defrost operation.

## 5. Switching Modes of Operation

The unit switches modes of operation based on an external input from a third-party device.

### 5.1 Switch from Cooling to Heating

When the Cooling/Heating contact is closed and all heating availability conditions are met, heating mode will initiate, and the following will occur:

- All currently operating compressors are shut down.
- The mode switch timer starts before completely switching to heating mode.
- The reversing valve moves to the heating position, if the unit is a heat pump.

### 5.2 Switch from Heating to Cooling

When the Cooling/Heating contact is open and all cooling availability conditions are met, cooling mode will initiate, and the following will occur:

- All heating devices are shut down.
- The mode switch timer starts before completely switching to cooling mode.
- The reversing valve moves to the cooling position, if the unit is a heat pump.

## 6. Digital Statuses

The Heat-Cool Only terminal strip provides the third-party controller with information from devices installed in the unit. The following information is available through those digital statuses.

### 6.1 Outside Air Damper Actuator End Switch

When installed, this status provides an indication that the outside air damper actuator has reached a specific open position.

### 6.2 Condensate Overflow Switch

This device, when installed, indicates when the condensate drain pan is full and further operation of the refrigeration system could cause an overflow of water in the pan.

### 6.3 Energy Recovery Status

When installed, the energy recovery device may have an indication back to the terminal strip that the device is rotating, or the bypass is open.

### 6.4 Filter Pressure Switch

If a filter pressure switch or switches are installed, an indication back to the third-party indicates that the filters are dirty.

### 6.5 Global Alarm Output



**Printed Date:** 10/24/2023  
**Job:** Oliver Ellsworth MS  
**Mark:** DOAS-1 CW  
**Model:** VXE-112-36D-CW-G-D1

The global alarm output is available on all Heat-Cool Only units. This status indicates that there is an alarm condition in the Heat-Cool Only controller.

## Warranty Statement for Dedicated Outdoor Air Systems (DOAS)

### Unit Warranty

Valent warrants the equipment to be free from defects in material and workmanship for a period of 18 months from ship date. Initial startup must be completed within six months of the shipment date, and a startup report must be submitted to Valent.

### Energy Wheel Warranty

The energy recovery wheel is warranted to be free from defects in material and workmanship for a period of 5 years from the shipment date. This warranty applies to all parts and components in the energy recovery cassettes with the exception of the motor.

### Heat Exchanger Extended Warranty

Valent warrants the stainless steel heat exchanger to be free from defects in material and workmanship for a period of 25 years from the shipment date.

### Warranty Notes

Any component which proves defective during the warranty period will be repaired or replaced at Valent's sole option when returned to our factory, transportation prepaid. All warranties do not include labor costs associated with troubleshooting, removal, or installation. Valent will not be liable for any consequential, punitive, or incidental damages resulting from use, repair, or operation of any Valent product. These warranties are exclusive and are in lieu of all other warranties, whether written, oral, or implied, including the warranty of merchantability and the warranty of fitness for a particular purpose. No person (including any agent or salesperson) has authority to expand Seller's obligation beyond the terms of this warranty, or to state that the performance of the product is other than that published by Seller.

*As a result of our commitment to continuous improvement, Valent reserves the right to change specifications without notice.*

### GKD Roof Curb

Model: GKD-45.9/173.9-G14

Curb Height (in.)	Curb Length (in.)	Curb Width (in.)	Material	Finish Type	Duct Adapter	Curb Weight (lb)
14	173.9	45.9	Galvanized	Galvanized	Yes	269

Standard Construction Features:
All dimensions shown are actual and in units of in.'s
If unit is selected with side or end discharge/return, there will not be bottom connections supplied with the curb.
14 gauge galvanized steel (perimeter channels).
14 gauge galvanized steel (interior channels).
Ships knocked down for field assembly.
Curb insulation to be provided by others.

Curb Detail

Top View of Curb

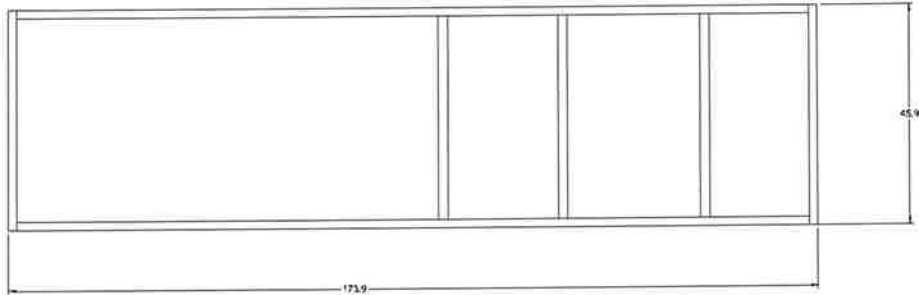

Cross-Section View of Unit on Curb

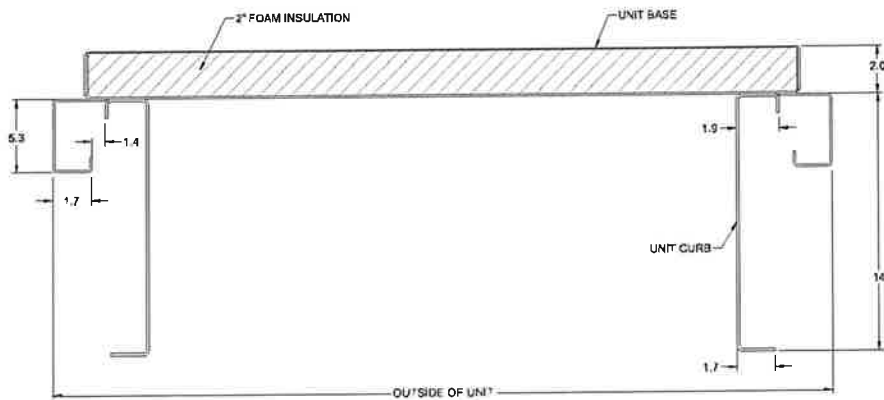



## APPENDIX D

# Drawings



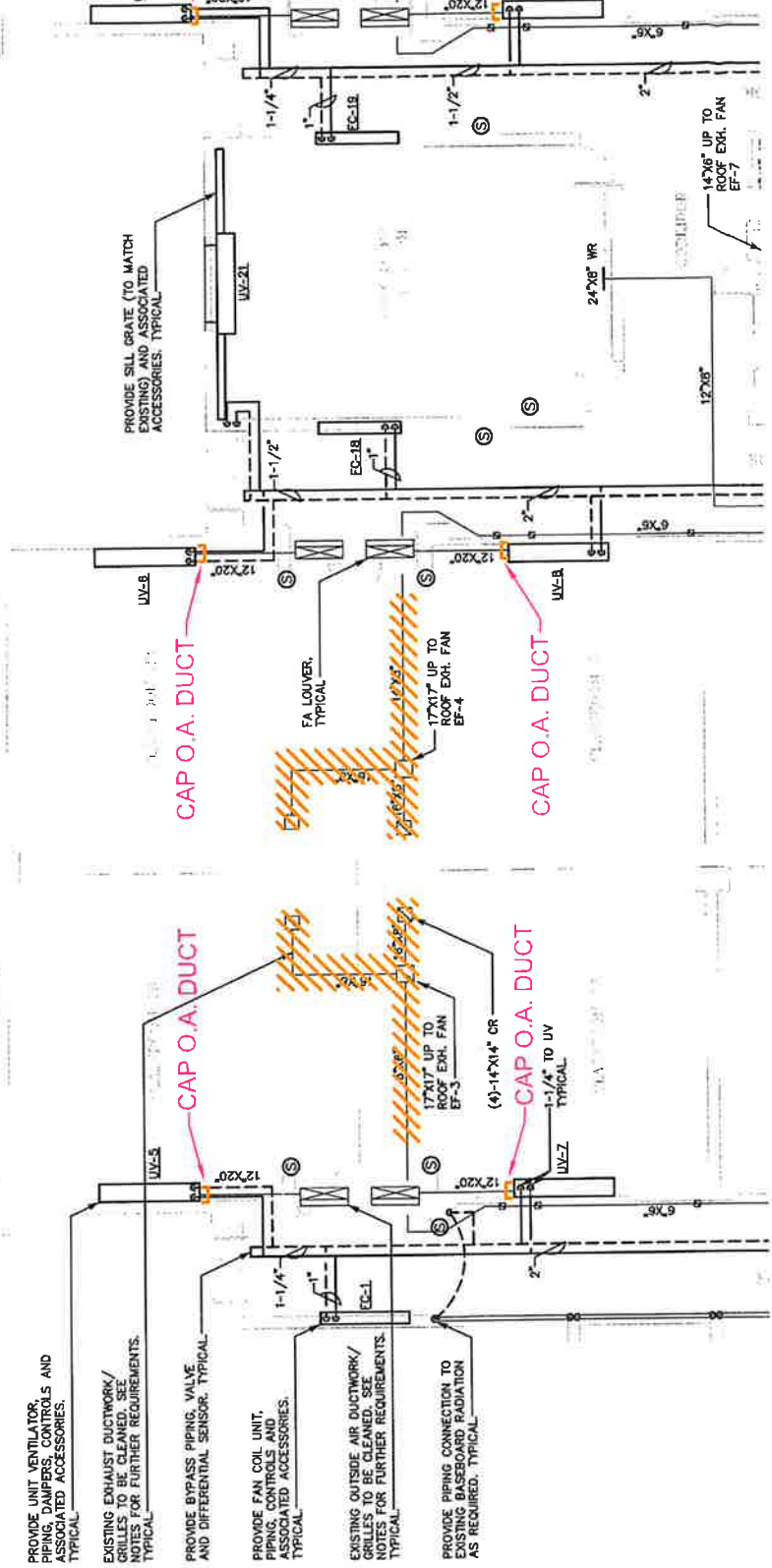

PROVIDE UNIT VENTILATOR, PIPING, DAMPERS, CONTROLS AND ASSOCIATED ACCESSORIES. TYPICAL.

EXISTING EXHAUST DUCTWORK/GRILLES TO BE CLEANED. SEE NOTES FOR FURTHER REQUIREMENTS. TYPICAL.

PROVIDE BYPASS PIPING, VALVE AND DIFFERENTIAL SENSOR. TYPICAL.

PROVIDE FAN COIL UNIT, PIPING, CONTROLS AND ASSOCIATED ACCESSORIES. TYPICAL.

EXISTING OUTSIDE AIR DUCTWORK/GRILLES TO BE CLEANED. SEE NOTES FOR FURTHER REQUIREMENTS. TYPICAL.

PROVIDE PIPING CONNECTION TO EXISTING BASEBOARD RADIATION AS REQUIRED. TYPICAL.

CAP O.A. DUCT

CAP O.A. DUCT

CAP O.A. DUCT

CAP O.A. DUCT

PROVIDE UNIT VENTILATOR,  
PIPING, DAMPERS, CONTROLS AND  
ASSOCIATED ACCESSORIES.  
TYPICAL.

EXISTING EXHAUST DUCTWORK/  
GRILLES TO BE CLEANED. SEE  
NOTES FOR FURTHER REQUIREMENTS.  
TYPICAL.

PROVIDE BYPASS PIPING, VALVE  
AND DIFFERENTIAL SENSOR. TYPICAL.

PROVIDE FAN COIL UNIT,  
PIPING, CONTROLS AND  
ASSOCIATED ACCESSORIES.  
TYPICAL.

EXISTING OUTSIDE AIR DUCTWORK/  
GRILLES TO BE CLEANED. SEE  
NOTES FOR FURTHER REQUIREMENTS.  
TYPICAL.

PROVIDE PIPING CONNECTION TO  
EXISTING BASEBOARD RADIATION  
AS REQUIRED. TYPICAL.

294 cfm

294 cfm

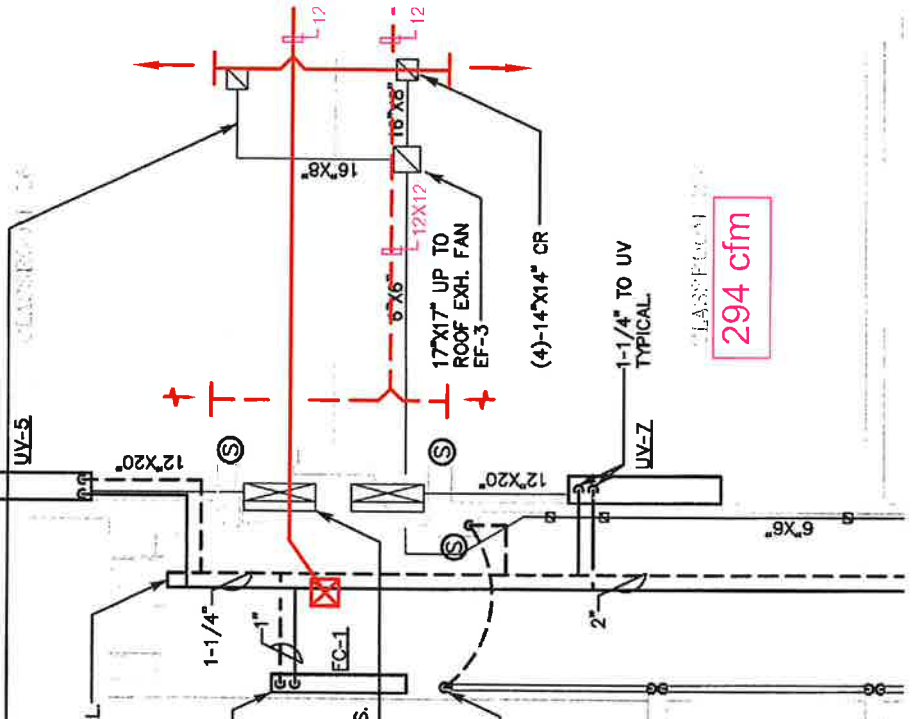

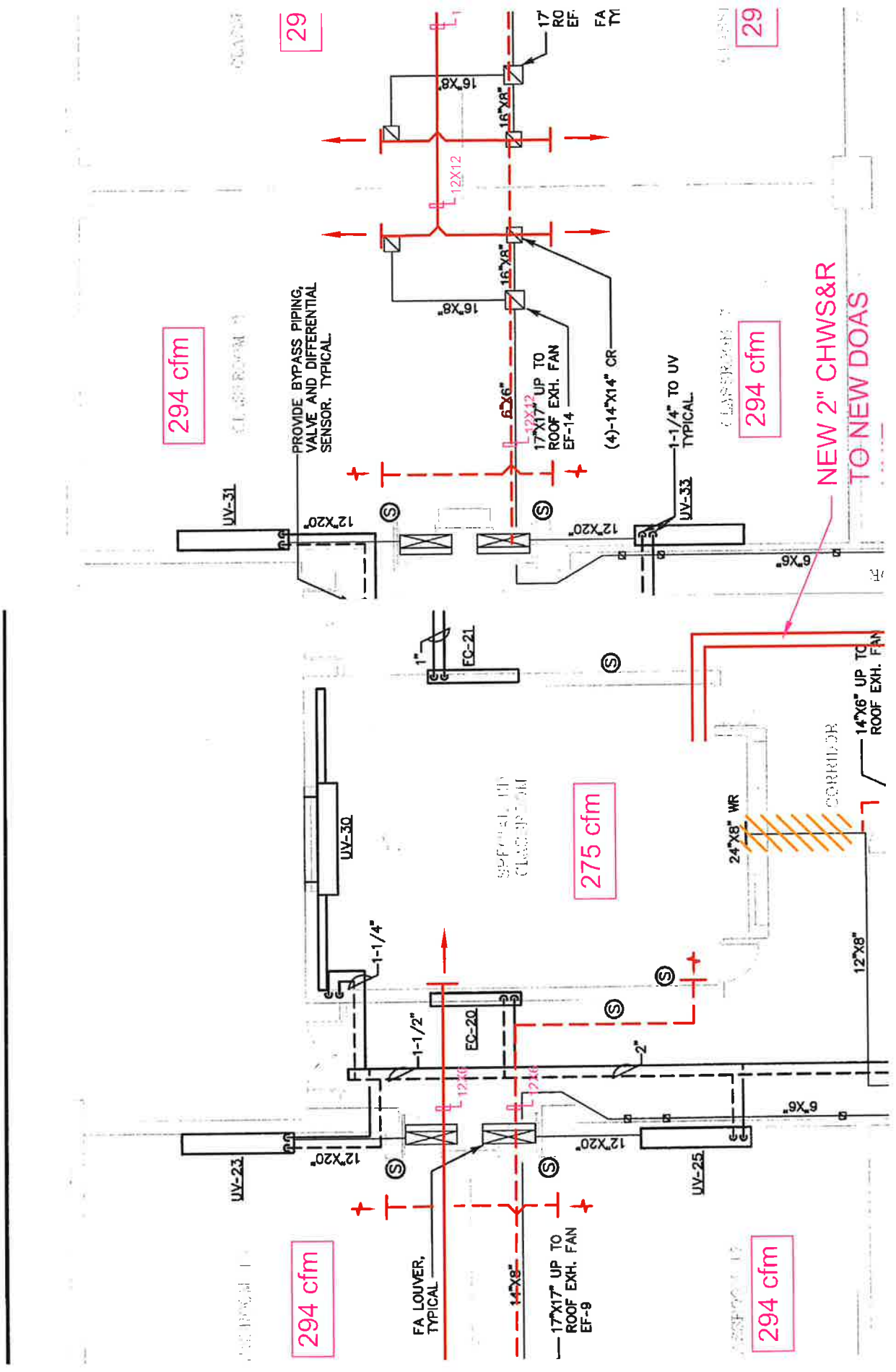

294 cfm

294 cfm

29

275 cfm

294 cfm

29

NEW 2" CHWS&R  
TO NEW DOAS

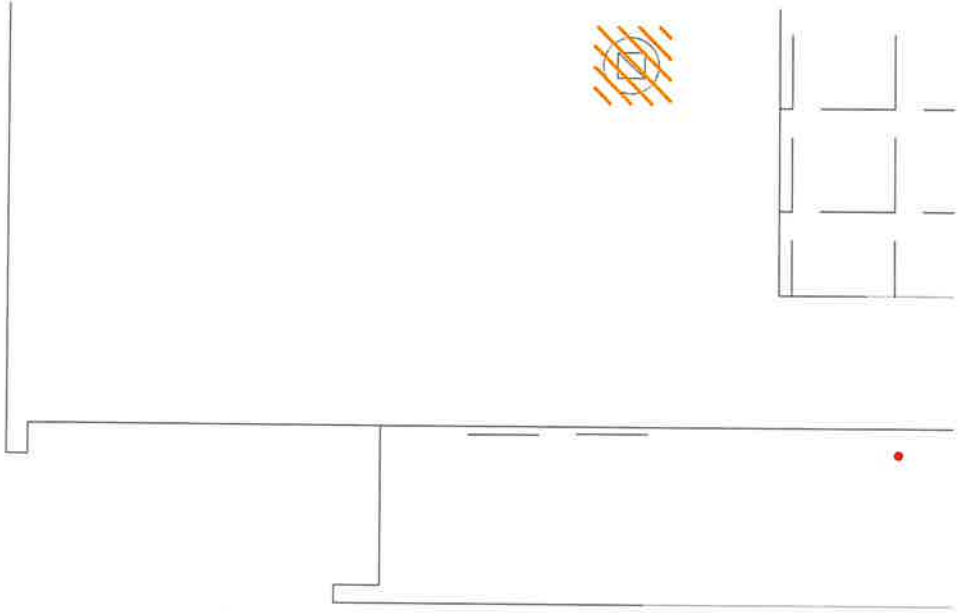
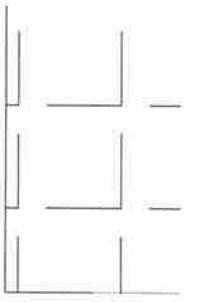

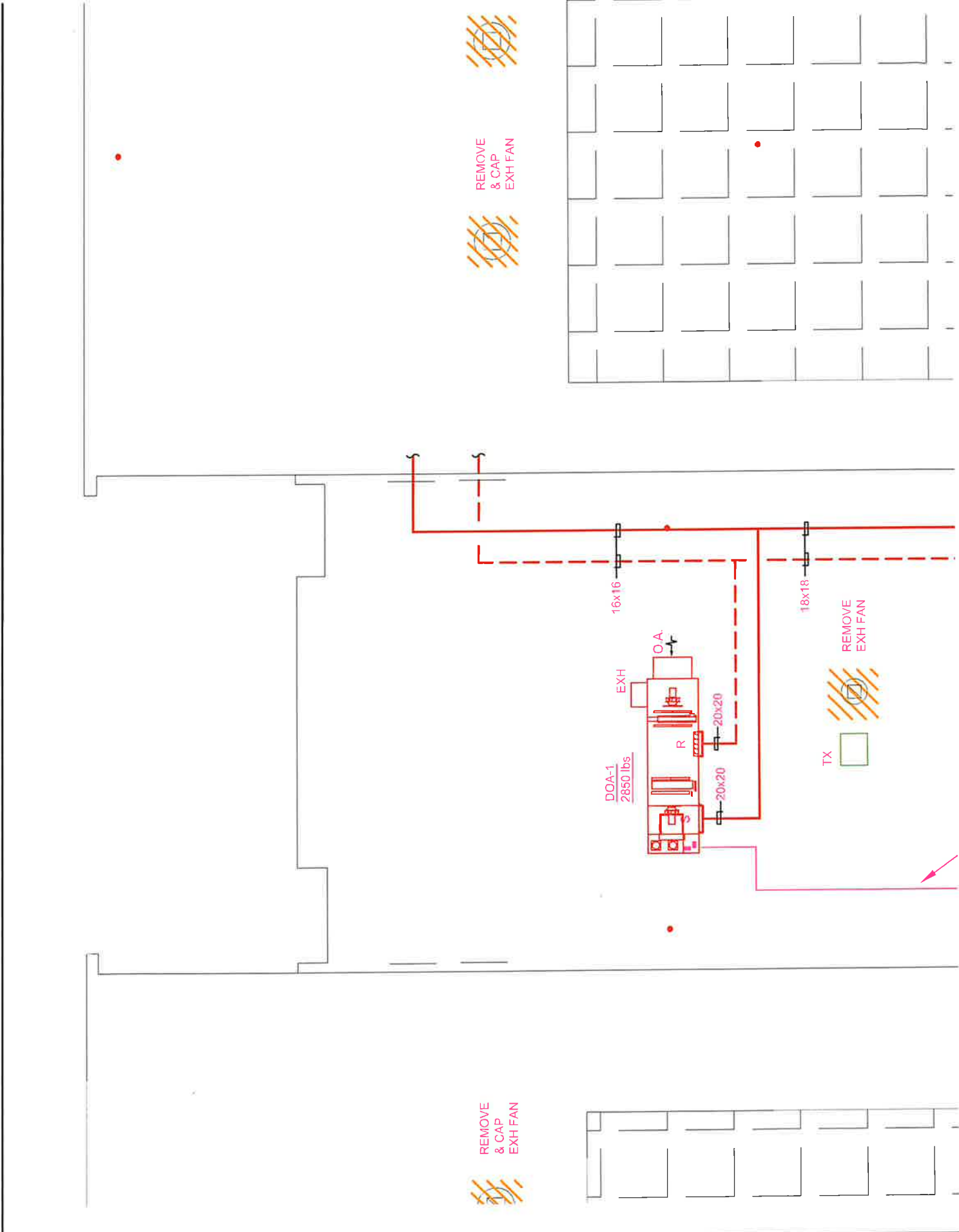

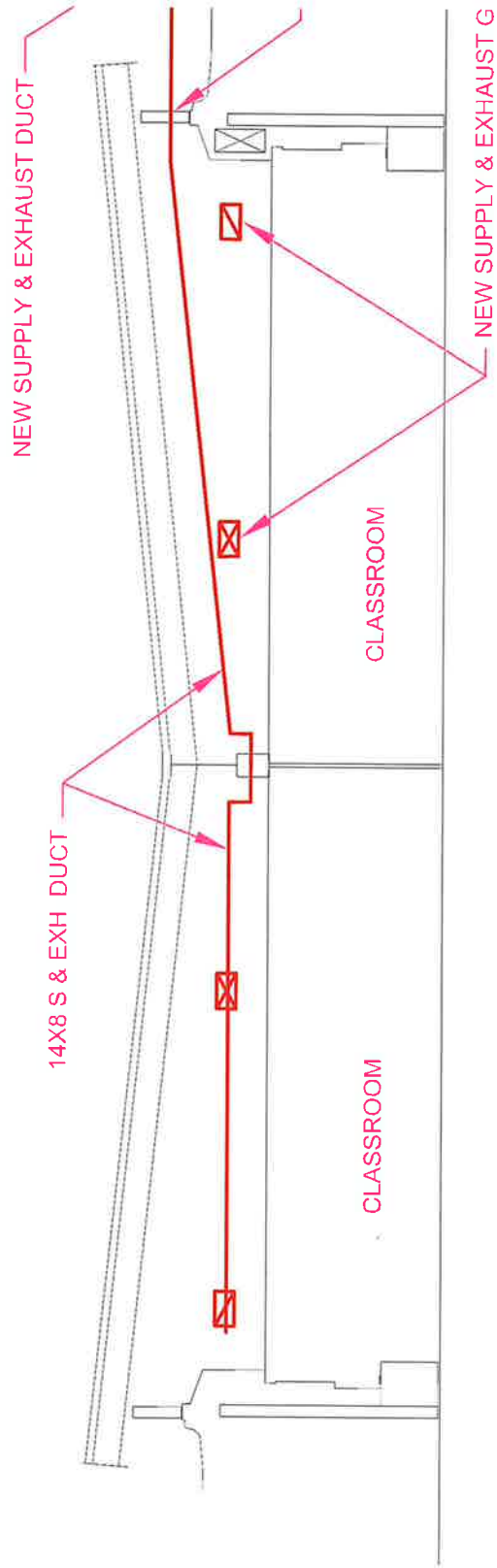

MECHANICAL NOTATION

**WINDSOR BOARD OF EDUCATION  
AGENDA ITEM**

**For Consideration by the Board of Education at the Meeting of:** February 21, 2024

**Prepared By:** Terrell M. Hill

**Presented By:** Leonard Lockhart, BOE Finance Chair

**Attachments:** N/A

**Subject:** Finance Committee's Recommendation Regarding the 2024-2025 Financial Plan and Adoption of the 2024-2025 Financial Plan (Anticipated Action)

---

**BACKGROUND:**

The Board of Education held a public forum on the budget process in December 2023 and one in January 2024. The Board of Education's Finance Committee held three separate meetings in January and February 2024 to review the budget in addition to holding three public forums prior to those committee meetings.

**STATUS:**

N/A

**RECOMMENDATION:**

Move the Board of Education accept the proposed 2024-2025 budget submitted to the Board by Superintendent Dr. Terrell Hill with a 6.40% increase over the current year's budget.

---

**Recommended by the Superintendent:** TH/sb

**Agenda Item #** 7.c.