

**AGENDA  
OURAY CITY COUNCIL**

**Monday, February 27, 2023 - 3:00 PM**

**Ouray Community Center  
320 6th Ave  
Ouray, CO 81427**

**VIRTUAL OPTION - <https://zoom.us/j/9349389230>**

Meeting ID: 934 938 9230 Passcode: 491878 Or dial: 408 638 0968 or 669 900 6833

**Ouray City Council Work Session**

- Changes to this agenda can be found on the bulletin board at City Hall
- Electronic copies of the Council Packet are available on the City website at [www.cityofouray.com](http://www.cityofouray.com). A hard copy of the Packet is also available at the Administrative Office for interested citizens.
- Notice is hereby given that a majority or quorum of the Planning Commission, Community Economic Development Committee, Beautification Committee, Tourism Advisory Committee, and/or Parks and Recreation Committee may be present at the above noticed City Council meeting to discuss any or all of the matters on the agenda below for Council consideration

1. CALL TO ORDER
2. DISCUSSION ITEMS
  - a. Land Use and Sign Code Changes
  - b. Community Development Fee Changes



P.O. Box 468  
320 Sixth Avenue  
Ouray, Colorado 81427

970.325.7211  
Fax 970.325.7212  
www.cityofouray.com

---

**TO:** Ouray City Council  
**FROM:** Lily Oswald, AICP (“Staff”)  
**DATE:** February 27, 2023  
**SUBJECT:** Updated Land Use and Development Code / Sign Code Draft - Work Session Topics

The updated Land Use and Development Code and Sign Code were updated for the Planning Commission’s consideration during the Special Meeting scheduled on December 20, 2022. The items below were set as future discussion items during the City Council and Planning Commission joint work session on January 23, 2023.

There are a few items which have to be considered by the City Council during upcoming meetings regarding the Land Use and Development Code. The Planning Commission recommended approval of the two chapters to the City Council with the condition *that the below outstanding items will be completed by the City Attorney and City Staff.*

1. Adopting the City’s Street Numbering provisions as a separate policy.
2. Completing the definition for “Sexually-Oriented Business”.
3. Drafting a Road & Bridge Impact Section (“Reserved” in Section 7-9-D-1).

The City Council should consider long-term effects of the land use code and sign code and the how those changes will affect the community, development, density, land use, and processes. Significant discussion items identified during the January 23, 2023 work session are outlined on page 2 for further consideration:

## LAND USE & DEVELOPMENT CODE:

1. **Fee Section** (pg. 8)
  - a. Changed to reiterate the recent fee Ordinance language
2. **Definitions** (pg. 9 - 17)
  - a. Do we need to define “affordable”?
  - b. Adult entertainment: City Attorney changes to definition
  - c. Sexually oriented businesses: City Attorney changes needed
3. **Public Notice Table** (pg. 22 - 23)
  - a. Add mailed notice for all Preliminary phases
4. **Uses by Right** (pg. 49 – 50)
  - a. C-1 & C-2 consider changing residential uses as *uses by right* to conditional to preserve commercial areas?
  - b. Nonconformity resulting from any changes in use for zoning district
5. **RV Conditional Use** (pg. 57):
  - a. Should the terms be the same as the RV work force housing permit terms
6. **Density Bonus Table** (pg. 64)
  - a. Change allowed bonuses to reflect higher AMI from definitions?
  - b. Add section for how to administer the increased allowed densities, deeds, allowances (City Attorney)
  - c. Increase density allowance?
7. **Dimensional Requirements** (pg. 65)
  - a. Setback exceptions:
    - i. C-1 front setbacks: extend no front setback through 10<sup>th</sup> Avenue
    - ii. Add area well and light well and stairs for basements
  - b. Decrease minimum lot sizes
  - c. Increase height maximum
8. **Parking requirement** (pg. 70)
  - a. Add section for how to round up or down for multi-family dwelling projects
  - b. Extend to 10<sup>th</sup> Avenue and down town 3<sup>rd</sup> Avenue (E-1-b)
  - c. Consider changing off-street parking requirements for section 1-c and 1-d (pg. 71)
9. **Subdivision Requirements/Impact Fees** (pg. 82)
  - a. Parks, Trails, Open Space, Recreation Facilities, Common Areas: only require for Major Subdivisions? Remove whole section and replace with reference to fee schedule?
  - b. Road & Bridge: section reserved for City Attorney and potential updated study
  - c. Does the City need subdivision requirements?
10. **General:** if changing requirements for the C-1 zone (parking, setback, height, etc.) change all sections of code from “4<sup>th</sup> Ave. to 9<sup>th</sup> Ave.” to “3<sup>rd</sup> Ave. to 10<sup>th</sup> Ave.”

## SIGN CODE:

1. **Neon Signs:** change language to “neon” or “LED” and “neon simulated”

Updated Discussion Draft (#6)

CHAPTER 7

Land Use and Development Code

Table of Contents

**Section 7-1 General Provisions..... 3**

    A Title and Short Title..... 3

    B Authority..... 3

    C Purpose of this Land Use Code..... 3

    D Applicability and Jurisdiction..... 4

    E Compliance Required..... 4

    F Rules of Interpretation/Conflicting Provisions..... 4

**Section 7-2 Administration and Enforcement..... 6**

**Section 7-3 Fees..... 7**

**Section 7-4 Definitions..... 8**

**Section 7-5 Development Review Procedures..... 17**

    A Purpose and Organization of Section..... 17

    B Summary Table of Procedures..... 17

    C Common Development Review Procedures..... 18

    D Specific Procedures and Approval Criteria..... 27

**Section 7-6 Zoning Districts..... 45**

    A Purpose..... 45

    B Zoning Map..... 45

    C Establishment of Districts..... 45

    D Purpose of Each Zoning District..... 46

    E Overlay Districts..... 46

**Section 7-7 Use Regulations..... 48**

    A Table of Allowed Uses..... 48

    B Home Occupations..... 50

    C Manufactured Home and Recreational Vehicle Park Standards..... 50

    D Telecommunications Antenna and Tower Standards..... 53

    E Recreational Vehicle Parking..... 54

    F Accessory Dwelling Units (ADUs)..... 57

G	Medical/Retail Marijuana .....	57
H	Short Term Rentals.....	57
I	Outdoor Displays of Merchandise.....	62
J	Intermodal Shipping Containers.....	62
K	Affordable, Attainable, and Workforce Housing.....	63
<b>Section 7-8</b>	<b>Dimensional Requirements and Development Standards.....</b>	<b>64</b>
A	Table of Dimensional Standards.....	64
B	Maximum Density/Minimum Lot Area.....	66
C	Setbacks.....	66
D	Building Height.....	68
E	Parking.....	69
F	Landscaping.....	72
G	Street Numbering.....	73
H	Snow Storage.....	73
I	Public Improvements – Sidewalks.....	73
J	Radiation Survey.....	73
<b>Section 7-9</b>	<b>Subdivision Design and Improvement Standards.....</b>	<b>74</b>
A	Purpose.....	74
B	General.....	74
C	Subdivision Design.....	74
D	Subdivision Dedication Requirements.....	80
E	Subdivision Improvements and Development Agreements.....	82
<b>Section 7-10</b>	<b>Annexation.....</b>	<b>86</b>

## Section 7-1 General Provisions

### A. Title and Short Title

Chapter VII of the City of Ouray Municipal Code, as amended from time to time, may be cited as the “Ouray Land Use Code”, “OLUC”, or “OMC”.

### B. Authority

It is the intention of the City in adopting this Code to fully exercise all relevant powers conferred on it by the laws of the State of Colorado, including, but not limited to, the following:

1. Home Rule Municipality. All powers reserved to the City as a home rule municipality under Article XX of the Colorado Constitution and its home rule charter.
2. State Enabling Legislation. All powers granted to the City by:
  - a. Colorado Revised Statutes, Title 29, Article 20, provisions of the Local Government Land Use Control Enabling Act of 1974.
  - b. Colorado Revised Statutes, Title 31, Article 12, provisions of the Municipal Annexation Act of 1965.
  - c. Colorado Revised Statutes, Title 24, Articles 65, 67, and 68, that provide for the review of areas and activities of state interest, authorize the [planned unit development](#) approach to land development and provide for the establishment of vested property rights.
  - d. Colorado Revised Statutes, Title 31, Article 23 that enables municipalities to adopt zoning regulations and subdivision requirements.
  - e. All Other Powers Authorized. All other powers authorized by statute or by common law for the regulation of land uses, [land](#) development and [subdivision](#), including, but not limited to, the power to abate nuisances.

### C. Purpose of this Land Use Code

The general purposes of the OLUC are as follows:

1. Promote and protect the public health, safety, and welfare;
2. Ensure that new [development](#) bears its fair share of the cost of providing new improvements and services;
3. Establish uniform procedures and standards for all proposed development of land with the City of Ouray;
4. To facilitate adequate provisions for water, sewage, storm water, fire protection, schools, parks, [open space](#), recreation, public utilities and other public and historical [buildings](#);
5. To maintain the scenic beauty of the Ouray area;
6. To manage development that mitigates and minimizes hazards due to erosion, [geologic conditions](#), flood, soil conditions, excessive [slopes](#) and other potential dangers to public health, safety and welfare;

7. Implement the goals, objectives, and policies of City's [Master Plan](#);
8. Preserve the neighborhoods and protect property values in Ouray;
9. Promote energy conservation, use of alternate energy sources, cluster development and other development land use practices that result in reduced energy consumption;
10. To encourage the development of affordable housing and encourage the development of long-term rental housing;
11. Protect quality of air, cultural or natural resources;
12. To protect the City's water resources by maintaining the natural watershed, preventing accelerated erosion, reducing run off and consequent sedimentation, and eliminating pollutants introduced directly or indirectly into the City's streams;
13. To manage and regulate the density of land use and prevent demands on existing services and infrastructure that cannot be satisfied;
14. To enhance and provide for safe and efficient flow of vehicles and pedestrians; and
15. To otherwise plan for and regulate the use of land to provide for a planned and orderly use of land and encourage the most appropriate use of land throughout the City.

**D. Applicability and Jurisdiction**

1. The provisions of this Land Use Code shall apply to all land, buildings, structures, and uses thereof located within the City of Ouray, unless an exemption is provided by the terms of this Land Use Code. The provisions of this Land Use Code are the minimum requirements adopted for the promotion of public health, safety, and welfare.
2. Jurisdiction: This Code shall be effective throughout the City's corporate boundaries.
3. A copy of a map showing the boundaries of the City is available for public inspection in the City offices.

**E. Compliance Required**

No building or structure shall be erected, converted, enlarged, reconstructed, or altered for use, nor shall any land, building, or structure be used or changed, except in accordance with all applicable regulations established by this Land Use Code.

**F. Rules of Interpretation/Conflicting Provisions**

For purposes of interpretation of the OLUC, the rules set out in this Section shall be observed, unless such construction would be inconsistent with the manifest intent or purpose of the City as expressed in this Chapter. Words and phrases shall be construed according to the common and approved language, but technical words and phrases as may have acquired a particular meaning shall be understood according to such meaning.

1. Conflicting Provisions

a. Whenever the requirements of the OLUC conflict with the requirement of another provision of the Ouray Municipal Code or any other rule, regulation, resolution, or ordinance of the [City](#), the requirements that are the most restrictive or impose a higher standard or requirements shall govern.

b. The provisions of the OLUC are in addition to all other City ordinances, the law of the State of Colorado, the law of the United States, and applicable common law. The OLUC shall not supersede any private land use regulations in deeds or covenants that are more restrictive than this Code.

2. Computation of Time

The time within which an act is to be done shall be computed in accordance with the City's Home Rule Charter.

a. Day. Day shall mean calendar day, including Saturdays, Sundays, and legal holidays.

b. Business day shall mean a day that the City offices are open to the public.

c. Week. The word "week" shall mean seven (7) days.

d. Month. The word "month" shall mean thirty (30) days.

e. Year. The word "year" shall mean 365 days.

3. Liability

The OLUC, or any administrative act or failure to act, pursuant to the regulations contained herein, shall not create any liability on the part of the City or any officer or employee thereof.

4. Severability

If any part of the OLUC or the application or enforcement thereof to any person or circumstance is held invalid, the remainder of the OLUC and its application to other person or circumstances shall not be affected thereby.

## Section 7-2 Administration and Enforcement

- A. The OLUC shall be administered and enforced by a Community Development Department Official, or other such authorized person as designated by the City Administrator.
- B. The City may deny any building permit, occupancy permit, other permit or license, or approval of any property that is in violation of any decision pursuant to the OLUC or the provisions of the OLUC.
- C. The City is empowered and directed to inspect and examine the use, occupation, or development of land for which a development permit, license or approval has been issued to determine, from time to time, whether any use, occupation, development, or activity is in violation of any of the provisions of this Code or of any permit issued or required pursuant to this or other applicable regulations.
- D. Should access or entry to any land or premises be refused upon request by the Community Development Department Official or other authorized person, the City may seek a search warrant from Municipal Court permitting entry upon such land or premises for purposes of making inspections or carrying out other duties as authorized under the Ouray Municipal Code.
- E. All provisions of the OLUC must be fulfilled and adhered to by Applicants seeking approval and authorization of the applicable sections of this Code. Failure to fulfill these requirements may result in the denial of building, development or other permits, and the authorization to improve, construct, occupy, subdivide, or utilize certain properties, buildings, and facilities. Additionally, all conditions specified in development approvals must be adhered to and completed in accordance with the approval conditions.
- F. It shall be unlawful for any person to subdivide any land within the City of Ouray whether by sale, conveyance, gift, delivery or recording of a plat, deed, or other legal instrument or by any other means except in accordance with the provisions of this Chapter.
- G. Any action which reduces the area of any site, lot, or tract in violation of the minimum dimensional requirements of the OLUC is unlawful.
- H. All violations of the OLUC, including the terms of any approval issued pursuant to this code, and any subdivision plat restrictions, are hereby declared to be a nuisance and may be abated in any lawful manner.
- I. The City may maintain an action in any court of competent jurisdiction to enjoin any violation of the OLUC, including terms and conditions specified in development approvals.
- J. It is unlawful to violate any of the provisions of the OLUC, or the terms of any approval. Any person convicted of such a violation may be punished by a fine of not more than one thousand dollars (\$1,000.00), per violation or by any other remedy authorized by law. Each day any violation continues shall constitute a separate offense. The provisions contained in Section 1-4 General Penalty in this Code shall also apply to violations of this OLUC.
- K. All remedies provided for in this section are cumulative, are not exclusive, and shall be in addition to any other remedies provided by law.

Ouray Municipal Code  
Chapter 7 – Land Use and Development Code

**Section 7-3 Fees**

- A.** Fees for applications and review processes shall be set by resolution of City Council, as amended from time to time.
- B.** Resolutions establishing application fees will attempt to establish fair and equitable fees to recover the average costs of all expenses, including staff time, associated with the administration of the OLUC.
- C.** .

## Section 7-4 Definitions

### A. OLuc Definitions

1. **Accessory Building** means a detached (separate or disconnected from) subordinate building or structure, the use of which is incidental to that of the principal building or primary dwelling, and which is located on the same lot or parcel with the principal building or dwelling.
2. **Accessory Dwelling** means a dwelling unit that contains no less than 300 sq. ft. and no more than 1000 sq. ft. of floor area and is located on the same site as, but has a separate entrance from, a single-family or duplex dwelling.
3. **Accessory Use** means a use on the same lot or parcel with the principal use that is naturally and normally incidental to, subordinate to, necessary for, or devoted exclusively to the main use of the premises.
4. **Adult Entertainment** is a commercial use which for a fee or incidentally to another service, regularly presents material or exhibitions distinguished or characterized by an emphasis on matter depicting, describing, or relating to specified sexual activities including sexual intercourse and fondling of buttocks, penises, vaginas, or breasts, for observations by patrons therein.
5. **Affordable Housing** means housing that is affordable to households with incomes at or below 80 percent of area median income (adjusted for household sizes).
6. **Alley** means a public way of more than 10 feet but equal to or less than 16 feet in width permanently dedicated to and owned by the City.
7. **Alteration** means a change, addition, modification or rearrangement in the structural parts, or an enlargement or reduction, whether by extending on a side or by increasing or reducing in height, or the moving from one location or position to another, of any building or structure.
8. **Applicant** means any Person and the successors or assigns of any such Person applying for development approval pursuant to this Code.
9. **Attainable Housing** means housing that is affordable to households with incomes at or below 120 percent of area median income (adjusted for household sizes).
10. **Block** means a parcel of land bounded on all four sides by streets or rights-of-way, or some other element such as public property, public easements, or open land.
11. **Block Front** means all lots whose frontage is on one side of a street between two intersecting streets.
12. **Building** means any structure used or intended for supporting or sheltering any use or occupancy.
13. **Building Frontage** means the lineal distance of the facade of a building measured along the lot frontage, which is occupied by a particular land use, measured from the edge of the building to the other edge of the building, or to the centerline of a wall separating uses.
14. **Commercial Motor Vehicle** means any motor vehicle, trailer, or semi-trailer designed or used to carry freight, passengers for a fee, or merchandise, in the furtherance of any commercial enterprise which may have a sleeper unit that is not a primary purpose of the vehicle.

15. **Commercial Use** means a business or activity where services, goods or commodities are exchanged for money or are carried out for pecuniary gain.
16. **Common Interest Community** means real estate described in a declaration with respect to which a person, by virtue of such person's ownership of a unit, is obligated to pay for real estate taxes, insurance premiums, maintenance or improvements of other real estate described in a declaration.
17. **Conditional Use** means a use of land within any zoning district that is authorized only when and if a conditional use permit is granted therefor in accordance with procedures and requirements as set forth in this Code.
18. **Condominium** means a common interest community in which portions of the real estate are designated for separate ownership and the remainder of which is designated for common ownership solely by the owners of separate ownership portions.
19. **Condominium Subdivision** means the division of real property into individual airspace units and their appurtenant common elements.
20. **Dedication** means the intentional appropriation of land by the owner for some public use.
21. **Density** means the number of dwelling units permitted on any parcel of property planned for any development.
22. **Development** means any activity or any person-caused change to land or improvements thereon that changes the basic character or intensity of the use of such land or improvements. Development shall include but not be limited to construction, change in intensity or type of use of land, demolition, clearing, excavating, filing, grading, paving, mining, dredging, or drilling.
23. **Duplex** means a building having two (2) dwelling units.
24. **Dwelling** means a permanent building or portion thereof that contains a kitchen and is used as the private residence or sleeping place of one or more human beings, but not including temporary structures.
25. **Dwelling Unit (D.U.)** means any permanent building or portion thereof, which consists of a room or suite of two (2) or more rooms used as a dwelling by one (1) family.
26. **Extended Stay Hotel** means a building containing guest rooms for lodging, offered to the public for compensation, which are advertised, designed, intended or routinely utilized for weekly or monthly occupancy, or in which at least 30% of all guest rooms have facilities for the refrigeration and preparation of food by guests, such as a refrigerator and a cooktop/stove (or a refrigerator, a microwave, and a dishwasher or kitchenette sink), a cook-top/stove or microwave, and a dishwasher or sink, and a self-serve laundry facility is available for guests use.
27. **Family** means eight (8) or fewer natural persons living together in a dwelling unit.
28. **Floor Area** means the sum of the horizontal areas of all floors in a building, as measured from the exterior face of exterior walls, or from the centerline of dividing walls, if appropriate. Garages, courts, decks, and porches are to be included when covered by a roof. Subterranean basement areas are excluded. For the purposes of calculating floor area, roof does not include any slated covering, pergola, or pervious covering.

29. **Final Plat** means the final map, drawn and submitted in accordance with Section 7-5-D-5-e of the OLUC as an instrument for recording of real estate interest with the County Clerk.
30. **Frontage** means the front side of a lot abutting upon one (1) side of the street or avenue between two (2) lot lines, measured along the right-of-way line. For lots that do not abut a street or avenue, the frontage of the lot may be an alley if the lot abuts an alley. For lots that do not abut a street, avenue or alley, the frontage of the lot shall be the street or avenue that is in closest proximity to the lot.
31. **Front Lot Line** means the property line parallel to the street or avenue. On corner lots the front shall be the line contiguous to a street, as opposed to an avenue. For lots that are not contiguous to a street or avenue, but contiguous to an alley, the front lot line means the property line parallel to the alley. For lots that are not contiguous to a street, avenue or alley, the front lot line means the property line parallel to the street or avenue in closest proximity to the lot.
32. **Geologic Condition** means a geologic phenomenon that may be adverse to land use as to constitute a threat to public health and safety or to property. This term includes but is not limited to avalanches, floods, landslides, rock falls, mudflows, debris flows, flooding, unstable or potentially unstable slopes, seismic effects, radioactivity, ground subsidence or presence of hazardous substances.
33. **Government Buildings and Facilities** means any building or facility owned and operated by the United States of America, the State of Colorado, the City of Ouray, or any agency or political subdivision thereof.
34. **Ground Floor** means the at-grade, ground floor, street-level floor or first floor of a building.
35. **Home Occupation** means any commercial use within a residential dwelling unit, an enclosed garage or accessory building that is carried on by the inhabitants of the property and that meets the standards of Section 7-7-B of the OLUC.
36. **Intermodal Shipping Container** means a prefabricated, reusable, metal container designed and intended for transporting cargo on ocean-going ships, trains, or tractor trailers, also commonly called cargo containers, transport containers or marine cargo containers. Includes Conex and railroad cars.
37. **Kitchen** means any room principally used, intended, or designed to be used for cooking or the preparation of food. The presence of a range or oven, or utility connections suitable for servicing a range or oven, shall normally be considered as establishing a kitchen.
38. **Land** means real property, including permanent improvements and usable air space.
39. **Landowner** means the owner in fee or any undivided interest in each parcel of land.
40. **Lodging Business** means a lodging unit, hotel, motel, lodge, inn, bed and breakfast, or hostel used for temporary occupancy for sleeping purposes, rented on a short-term basis of less than thirty (30) consecutive calendar days or as an extended stay hotel, pertaining to properties assessed with a commercial tax rate, and excludes short-term rental as defined herein.

41. **Lodging Unit (L.U.)** is an individual unit or room, which may or may not include a kitchen, within a lodging business customarily rented on a short-term basis of less than thirty (30) days, pertaining to properties assessed with a commercial tax rate.
42. **Long Term Rentals** means any rental or lease of property, dwelling unit, or part thereof, for thirty days or more.
43. **Lot** means a measured portion of a subdivision intended as a unit for transfer of ownership, lease, or for development, or a parcel of real property designated by a separate and distinct number or letter on a plat filed with the Ouray County Clerk and Recorder, or when not platted in a recorded subdivision, a parcel of real property held under separate ownership or capable of being conveyed to a separate owner without being subject to the City's Subdivision Regulations.
44. **Lot Area** means the total horizontal area within the lot lines of a lot.
45. **Lot Side** means any property line other than the front or the rear lot line.
46. **Major Streets** are those public streets which collect traffic from minor streets, or which permit the relatively rapid and unimpeded movement of traffic from one part of the community to another.
47. **Manufactured Home** means a structure transportable in one or more sections, which is built on a permanent chassis and is designed for use with or without a permanent foundation when connected to the required utilities, and which has certification required by the United States Secretary of Housing and Urban Development and was constructed in compliance with the requirements of 42 U.S.C. § 5401, *et seq.*, *Manufactured Home Construction and Safety Standards*, and the regulations of the Department of Housing and Urban Development that are promulgated thereunder. The phrase "manufactured home" does not include a recreational vehicle, nor does it include a mobile home; also defined in Chapter 6 of the Ouray City Code.
48. **Master Plan** means the Ouray Community Plan adopted pursuant to C.R.S. §31-23-206, as amended from time to time, also referred to as the Ouray Community Plan, City Community Plan, Community Plan, Comprehensive Plan, or Master Plan – all intended as the same for the purpose of this land use code.
49. **Maximum Building Site Coverage** means the area covered by all buildings (including covered or uncovered porches, carports, decks, garages, and cantilevered features (not including roof eave overhangs)) divided by the area of the site with both calculated in the horizontal plane as illustrated below.
50. **Maximum Building and Impervious Surface Site Coverage** means the area covered by buildings including covered or uncovered porches, carports, decks, garages, and cantilevered features (not including roof eave overhangs), and impervious surfaces, such as concrete or asphalt pavement, divided by the area of the site, all calculated in the horizontal plane.

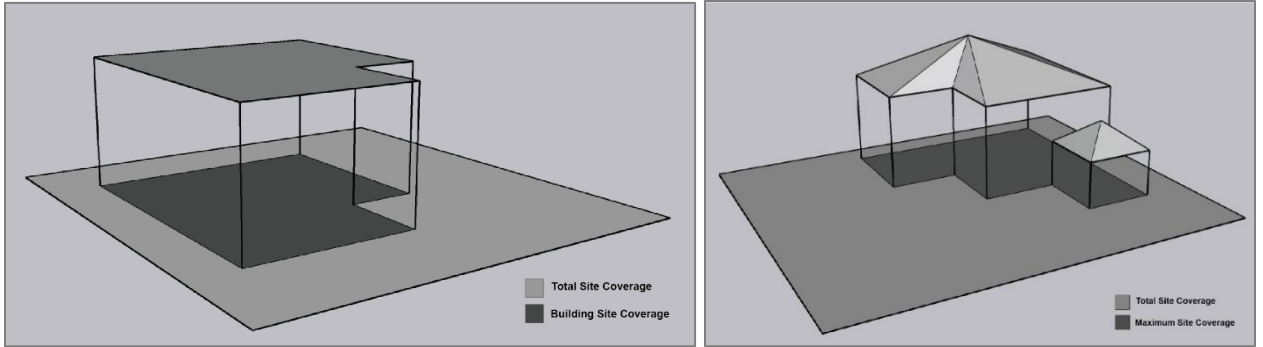

51. **Maximum Building Height** is measured vertically from the highest point of the building, excluding any chimneys, to the average grade of the building, halfway between the lowest and highest ground elevations of the building as illustrated below.

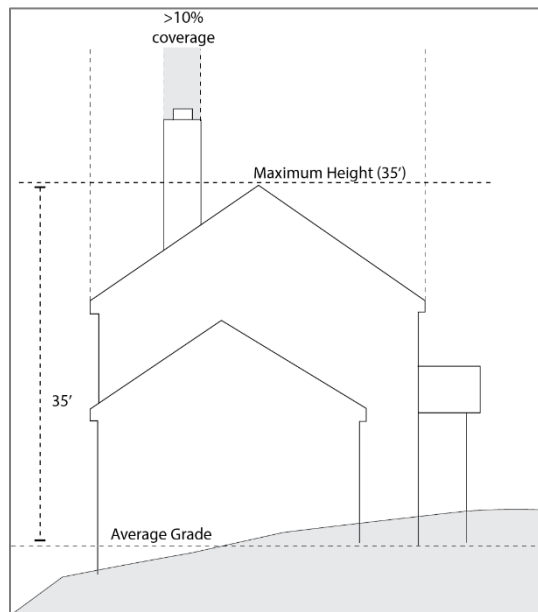

52. **Minor streets** are public streets used primarily for direct access to properties abutting the right-of-way. Minor streets carry traffic having a specific origin or destination and do not carry thru traffic.
53. **Mixed Use** means a development in which a combination of residential and commercial uses (*e.g.*, residential-over-retail), or several classifications of commercial uses (*e.g.*, office and retail), are located on the same parcel proposed for development. A minimum of 500 square feet of non-residential space must be provided for each dwelling unit.
54. **Mobile Home** means structure designed to be transported after fabrication and exceeding eight (8) feet in body width or thirty-two (32) feet in body length. Such a structure is built on a chassis and retains the chassis on which it was built, whether such structure is placed on a permanent foundation. Such a structure is suitable for human habitation on a year-round basis when provided with the required plumbing, heating, and electrical facilities. Mobile homes are different from manufactured homes in that they were either constructed before the adoption of 42 U.S.C. § 5401, *et seq.*, *Manufactured Home Construction and Safety Standards*, or are otherwise not in

compliance with said federal law and its implementing regulations. The phrase "mobile home" does not include "recreational vehicle."

55. **Mobile Home Park** means a parcel of land under single ownership that has been planned and improved for the placement of two or more mobile homes for dwelling or sleeping purposes, whether or not a fee is charged for use of the property.
56. **Modular Home** means a form of housing that is constructed off-site and built to adopted or accepted local and state building codes. Modular homes are transported from construction facilities to the site in sections or in completed assemblies.
57. **Multi-Family Dwelling** means a building with three (3) or more dwelling units.
58. **Nonconforming Lot or Parcel** means a lot or parcel of land which as the result of the adoption of dimensional regulations contained within this Chapter fails to meet the minimum dimensional requirements for the Zoning District in which it is located.
59. **Nonconforming Structure** means a structure which was originally constructed in conformity with zoning and building code or ordinances in effect at the time of its development, but which no longer conforms to the dimensional or other requirements imposed by the Chapter for the Zoning District in which it is located.
60. **Nonconforming Use** means the use of land or a building or structure which was originally established in conformity with the zoning and building code or ordinances in effect at the time of its development, but which is no longer allowed as a permitted or conditional use under the regulations imposed by this Chapter for the Zoning District in which it is located.
61. **Open Space** means land uncovered by structures, streets, parking, or driveways and typically maintained in its natural state.
62. **Parcel** means Lot, as defined herein.
63. **Parking Space** means a surfaced area, enclosed or unenclosed, 10 feet by 20 feet and reserved for the parking or storage of one (1) motor vehicle. Includes spaces reserved for accessible parking and electronic vehicle charging.

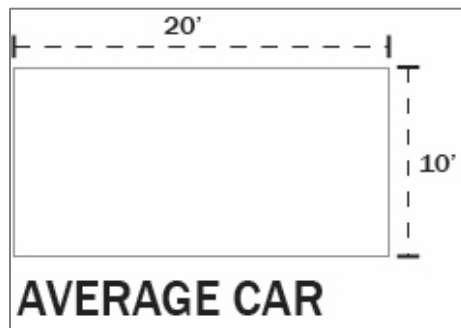

64. **Permitted Use** means a use of land within any particular zoning district that is authorized as a matter of right so long as all other requirements of this Code are met.
65. **Person** means a natural person, association, firm, partnership, corporation, joint venture, club, trust, or other organization acting as a group or unit, or the manager, lessee, agent, servant, officer, or employee of any of them.

66. **Planned Unit Development (PUD)** means an area of land, controlled by one or more landowners, to be developed under unified control or unified plan of development for a number of dwelling units, commercial, educational, recreational, or industrial uses, or any combination of the foregoing, the plan for which does not correspond in lot size, bulk, or type of use, density, lot coverage, open space, or other restrictions in this Code.
67. **Plat** means a printed instrument that is a land survey depicting all or a portion of a land area in two dimensions.
68. **Preliminary Plat** means the map of a proposed subdivision and supporting materials, drawn and submitted in accordance with Section 7-5-D-5-d of the OLUC to permit review of detailed engineering and design.
69. **Private streets** are streets not owned by the City.
70. **Property Line** means a line delineating a property, or portion of land, from another property, right-of-way, easement, etc. and documented by a recorded survey or plat.
71. **Public Utility Service Facilities** means transmission and storage facilities, including but not limited to pipes, lines, mains, wires, transformers, valves, and other related appurtenances for petroleum products, electricity, water, sewage, drainage, telephone, internet, wireless and cable television which are necessary to provide service to customers, but does not include building, offices, and production or generation facilities.
72. **Rear Lot Line** means the property line opposite the lot front.
73. **Recreational Vehicle (RV)** means a vehicular or portable unit mounted on a chassis and wheels, which either has its own motive power or is mounted on or drawn by another vehicle, such as travel trailers, fifth wheel trailers, camping trailers, or motor homes, but excluding truck campers. A recreational vehicle is not designed or intended for use as a permanent dwelling or sleeping place, but is to provide temporary living quarters for recreational, camping, or travel use.
74. **Recreational Vehicle (RV) Park** means a parcel of land on which RVs, either occupied or intended to be occupied on a short-term or seasonal basis for dwelling or sleeping purposes, are located and infrastructure, utilities and facilities are located, regardless of whether or not a charge is made for such accommodations.
75. **Setback** means the minimum horizontal distance allowed between a lot line and any exterior part of a building, including decks, covered porches, and other appendages located above ground level other than the roof eave.
76. **Sexually Oriented Business.** Such businesses include sexually oriented theaters, bookstores, or ?
77. **Short-Term Rental (STR)** means the use of a dwelling unit, or any part thereof, for remuneration, for less than thirty (30) consecutive calendar days, pertaining to properties assessed with a residential tax rate.
78. **Single-Family Dwelling** is a dwelling unit designed for and occupied exclusively by one (1) family.
79. **Site** means the contiguous lots, tracts, and parcels of property associated with any use.

80. **Site Coverage** means that portion of a lot or parcel that is covered by buildings, measured where the exterior wall meets the foundation, including cantilevered features, but excluding roof eaves, uncovered decks, and patios.
81. **Site Specific Development Improvement Agreement** means a written contract between the City and the site-specific development application in which the Applicant agrees to pay for curb, gutter and sidewalk associated with a site-specific development permit required as necessary to ensure the proper and timely installation of improvements.
82. **Slope** means an inclined ground surface which is expressed as a ratio of vertical distance to the horizontal distance or rise over run.
83. **Street** means a public or private way, other than alley, that affords the principal means of access to abutting property.
84. **Structure** means anything constructed, installed, or erected which requires location on the ground or is attached/supported by something on the ground, inclusive of buildings, signs, roads, walkways, berms, fences and/or walls greater than six feet (6') in height, tennis courts, swimming pools and the like, but excluding poles, lines, cables, or similar devices used in the transmission or distribution of public utilities.
85. **Subdivision** means the division of any land into two (2) or more lots, parcels, tracts, plats, sites or separate interests, or such other division, for the purpose, whether immediate or future, or sale or transfer of ownership, or for building or other development, or for the creation of streets or other rights-of-way. Subdivision shall also mean the consolidation, aggregation, and reconfiguration of lots. Unless otherwise specified, the term subdivision does not apply to any of the following divisions of land:
- a) Created by order of a court of competent jurisdiction in this state or by operation of law, provided that the City is given notice of and an opportunity to participate in any judicial proceedings prior to the entry of any such court order;
  - b) Created separate but undivided interests in a tract of land such as joint tenancy, tenancy in common, tenancy in entirety, trust, lien mortgage, deed of trust or other security interest, unless such separate interests apply to less than all of the tract;
  - c) Which create cemetery lots;
  - d) Which create an interest in oil, gas, minerals, or water which is severed from the surface ownership or real property; or
  - e) Which create a utility easement or an easement unrelated to the use of the surface estate.
86. **Subdivision Improvements Agreement** means a written contract between the City and a subdivider providing for and describing conditions of approval for the subdivision. It shall, at a minimum, set forth construction specifications for required public improvements, provide dates for completion of the improvements, and identify the terms and conditions for the acceptance of the improvements by the City. It shall also provide for such financial assurance as necessary to insure the proper and timely installation of improvements.

87. **Subdivision Plat** means a map of certain described land prepared by a registered land surveyor in accordance with Section 7-5-D-5 as an instrument for recording of real estate interest with the County Clerk.
88. **Sketch Plan** means a map of a proposed subdivision or other development, drawn and submitted in accordance with Section 7-5-D-5-c of the OLUC to evaluate feasibility and design characteristics at an early stage in the planning.
89. **Substantial Conformity** means there is no variation from preliminary plat, other than minor changes in the size of lots, or location of lot lines, easements, or streets. Any change in types or numbers of land uses, any variance in residential density, any change in location of a public right-of-way in excess of five feet (5') or any variation of a dimensional limitation in excess of five percent (5%) shall not be included in the definition of Substantial Conformity.
90. **Subterranean** means any portion of the structure or building devoted solely to parking and storage uses and is also primarily underground with less than one foot of the foundation wall exposed except for required means of ingress/egress or non-walkout, vehicular access garage door.
91. **Time Sharing** means interval estate, time share estate, or timespan estate as such are defined in C.R.S. §38-33-110, as may be amended, or any other similar concept of property ownership involving either interval ownership or fractional fee interest as may be determined by the City Council. Time Sharing shall also include time share or time share interest, but not a time share license or use.
92. **Tiny home** means a dwelling unit that has less than four hundred (400) square feet of livable space, including lofts. A tiny home is not a vehicle or recreational vehicle and has no wheels.
93. **Use** means a specified activity or purpose for a property, building, residence, facility, or other structure for which it is intended, designed, platted, arranged, and occupied.
94. **Variance** generally means a grant of relief from the literal requirements of this Code which permits activity in a manner that would otherwise be prohibited by this Code.
95. **Workforce Housing** means housing that is affordable to households with incomes at or below 150 percent of area median income (adjusted for household sizes) and intended for individuals or families that live and work in Ouray or Ouray County at least 32 hours per week on average.
96. **Yard** means the portion of a lot which does not have a structure located thereon and which is unobstructed from ground to the sky.

**Section 7-5 Development Review Procedures**

**A. Purpose and Organization of Section**

This section outlines the common and specific procedures required for all types of land use review. The Administrator or Planning Commission has the ability to refer any application to the next higher level of decision authority if they deem the project impacts are substantial and necessitate a higher level of review.

**B. Summary Table of Procedures**

<b>Table 7-5-B: Summary Table of Procedures</b>				
<b>R = Review (Review or Recommend)</b>	<b>D = Decision (Responsible for Final Decision)</b>			
<b>H = Public Hearing Required</b>	<b>A = Appeal (Appeal Authority)</b>			
<b>Procedure</b>	<b>Section</b>	<b>Administrator</b>	<b>PC</b>	<b>City Council</b>
Comprehensive Plan, Adoption and Amendments	<b>C.R.S. §31-23-206</b>		R	D
Rezone & Initial Zoning	<b>7-5-D-1</b>	R	R	D
Annexation	<b>7-10</b>	R	R	D
Conditional Use Permits	<b>7-5-D-3</b>	R	D - H	A
Variances	<b>7-5-D-4</b>	R	D - H	
Short Term Rental Appeals	<b>7-7-H-16</b>	R		A
Site Development Permit, other than one SFR	<b>7-5-D-2</b>	D		
Site Development Permit, one single family residence or ADU	<b>7-5-D-2</b>	D		
Site Development Permit – Limited Amendment (minor revisions)	<b>7-5-D-2</b>	D	A	
Sign Permit	<b>Chapter 8</b>	D		
Appeals of Administrative Decisions (except STR)	<b>7-5-E-7</b>	R	A	
Vacation of ROW		R	R	D - H
<b>Planned Unit Developments</b>				
Sketch PUD	<b>7-5-D-5-j</b>	R		
Preliminary PUD	<b>7-5-D-5-j</b>	R	R-H	D - H
Final PUD	<b>7-5-D-5-j</b>	R	R-H	D - H
<b>Subdivisions</b>				
Lot Split	<b>7-5-D-5-f</b>	D	A	
Amended Plat	<b>7-5-D-5-h</b>	R		D - H
Minor Subdivision	<b>7-5-D-5-i</b>	R	D - H	A - H
Subdivision Sketch plan	<b>7-5-D-5-c</b>	R	D	
Subdivision Preliminary Plat	<b>7-5-D-5-d</b>	R	R	D - H
Subdivision Final Plat	<b>7-5-D-5-e</b>	D		A - H
Condominium/Townhouse Plat	<b>7-5-D</b>	R	R	D
Replat/Boundary Adjustment	<b>7-5-D-5-g</b>	D	A	

## C. Common Development Review Procedures

### 1. Pre-Application Conference (Optional)

#### a. Purpose

The purpose of a pre-application conference is to provide an opportunity for an informal evaluation of the applicant's proposal and to familiarize the applicant and the Administrator with the applicable provisions of this Land Use Code, any Comprehensive or other applicable City Plans or Policies, [infrastructure](#) requirements, and any other issues that may affect the applicant's proposal.

#### b. Pre-Application Conference

The potential [applicant](#) shall request a pre-application conference with the Administrator and pay the required fees, if any. With the request for a pre-application conference, the applicant shall provide to the Administrator a description of the [character](#), location, and magnitude of the proposed [development](#) and any other available supporting materials, such as maps, drawings, [site](#) plans or models. It is the applicant's responsibility to provide sufficiently detailed plans and descriptions of the proposal for the Administrator to make informal recommendations regarding the proposed project. At the conference, the applicant, the Administrator or designee, and any other persons the Administrator deems appropriate to attend shall discuss the proposed development and the applicable requirements of this Land Use Code, based on the information provided by the applicant. The informal evaluation and comments provided by the Administrator at the conference are not binding upon the applicant or the City but are intended to guide the applicant through the application and submittal process and advise the applicant in advance of issues that may be relevant to the respective board or commission though not exhaustive.

### 2. Application

a. Application Requirements: A uniform application is used for every process under this Code. However, additional information may be required at each level of a multi-level application such as a subdivision. Each and every application under this Code shall include, or be accompanied by, the following information, unless waived by the Administrator:

i. The name, mailing address, and telephone number(s) of the applicant for the permit.

ii. The owner(s) of the property upon which the improvement or use is to take place.

iii. Any agents authorized to act on behalf of the owner or the applicant.

iv. Any contractor retained or to be retained to accomplish any portion of the improvement.

v. Proof of ownership of the property in question and concurrence in the purpose of the application by the owner.

vi. Legal description of the property in question, to include:

1. legal address;

2. account number;

3. or other recorded identifying parcel number.

- vii. Current zoning classification of the [parcel](#).
- viii. A copy of a certified survey [plat](#) may be required or a [sketch plan](#) which shows the relative location of existing and proposed improvements, [buildings, structures](#), roads, driveways, [slope](#), parking, ditches, utilities, fences, and other significant features present on the [site](#).
- ix. A written description of the nature of the improvement planned, if any.
- x. Architect or engineer drawings, floor plans, and diagrams as may be required by the Administrator.
- xi. Proof that a request for a driveway permit has been submitted to the Colorado Department of Transportation, if a new access road or driveway to the property intersects with the state highway.

b. Authority to File Applications

Unless otherwise specified in this Land Use Code, applications for review and approval may be initiated by the owner of the property that is the subject of the application or the owner's authorized agent. When an authorized agent files an application under this Land Use Code on behalf of a property owner, the agent shall provide the City with written, documentation that the owner has authorized the filing.

c. Submittal Requirement Waiver

The Administrator may waive certain submittal requirements if it is deemed unnecessary for the review of the project and associated [development](#) impacts. The Administrator will provide a report detailing the exact waivers and explanation on why they are not necessary, and the report will become part of the application and project file.

d. Additional Information

Additional application-specific information, beyond that specified, may be required by the Administrator, Planning Commission, and/or City Council, as necessary and appropriate to evaluate fully whether an application complies with the requirements of this Land Use Code.

e. Inactive Files

If an applicant fails to submit required information or request a hearing date within six (6) months from the application date, the file may become void, and the re-submittal of a new application and fees may be required. The Administrator may grant extensions of time to this provision, upon a written request by the applicant if the extension request is received within 6-months of the original application termination date.

f. Determination of Application Completeness

The Administrator shall only initiate the review and processing of complete applications. The Administrator will decide application completeness within 7 days of receipt of the application by the Administrator. If the application is determined to be complete, the application shall then be processed according to the procedures set forth in this Land Use Code. If an application is determined to be incomplete, the Administrator shall provide notice to the applicant along with

an explanation of the application’s deficiencies. No further processing of an incomplete application shall occur until the deficiencies are corrected in a future re-submittal.

i. An application will be considered complete if it is submitted in the required form, includes all mandatory information, including all supporting materials, and is accompanied by the applicable fee. Information shown must clearly indicate compliance with applicable development standards, or in the case of a request for a [variance](#) or modification to certain standards, the degree to which the application will be non-compliant.

ii. Any supplemental technical reports and special studies that are submitted following the original application must be received at least 30 days prior to the first hearing to be held on the application. The City may postpone and reschedule a hearing or approval deadline if such reports and studies are submitted less than 30 days prior to a hearing. Copies of such additional materials shall be delivered to all reviewers who received the original application packet.

g. Administrator Reviews Application and Prepares Staff Report

After determining that a development application is complete, the Administrator shall refer the development application to the appropriate board or commission, ensure all required notices are completed, review the development application, and prepare a Staff Report. The Staff Report shall be made available for inspection and copying by the applicant and the public prior to any scheduled public hearing(s) on the application. The Staff Report shall indicate whether, in the opinion of the Administrator, the development application complies with all applicable standards of this Land Use Code.

3. Notice of Public Hearing(s)

a. Content of Notices: Notice of all public hearings required under this Land Use Code shall: (1) identify the date, time, and place of the public hearing, (2) if applicable, describe the property involved in the application by [street](#) address or by legal description; (3) describe the nature, scope, and purpose of the proposed action; (4) indicate that interested parties may appear at the hearing and speak on the matter; and (5) indicate where additional information on the matter may be obtained.

b. Summary of Notice Requirements

[Table 7-5-C](#) lists the notice requirements for all procedures in this Chapter.

c. Published Notice

When [Table 7-5-C](#) requires that notice be published, the City Clerk shall publish notice of a public hearing in a newspaper of general circulation at least 12 days prior to the scheduled hearing date.

d. Mailed Notice

When [Table 7-5-C](#) requires that written notice be provided, such notice shall be mailed by the City no less than 15 days prior to the public hearing, by certified mail, to the applicant, appellant, or [landowners](#) subject to a land use application, subject property, neighboring property owners whose properties are within 300 feet of the lot that is the subject of the

application or appeal (based on information found in the Ouray County tax records), and any other person who makes a written request for such notice.

e. Posted Notice

When [Table 7-5-C](#) requires a posted notice, the City shall post notice of the public hearing at City Hall no less than 15 days prior to the public hearing.

i. When [Table 7-5-C](#) requires a posted notice, the City shall post at least one sign on the lot, parcel, or tract of land, and such sign shall remain on the property for a period of at least 5 days prior to the public hearing. The sign shall be posted in a prominent place, clearly visible from the most heavily traveled adjacent street or public way. The Administrator may require that additional signs be posted depending on the access and configuration of the property.

f. Notice to Mineral Estate Owners and Lessees

When [Table 7-5-C](#) requires that notice be provided to mineral estate owners and lessees, the applicant shall provide notice of the application by certified mail, return receipt requested, to all mineral estate owners and lessees on the subject property in accordance with C.R.S. Section 24-65.5-103. Such notice shall be provided not less than 30 days prior to the initial public hearing, or not less than 30 days prior to the final decision if the application does not require a public hearing. It shall be the applicant’s responsibility to conduct the necessary research to determine mineral estate owners and lessees on the subject property.

g. Constructive Notice

Minor defects in any notice shall not impair the notice or invalidate proceedings pursuant to the notice if a bona fide attempt has been made to comply with applicable notice requirements. Minor defects in notice shall be limited to errors in a legal description or typographical or grammatical errors that do not impede communication of the notice to affected parties. In all cases, however, the requirements for the timing of the notice and for specifying the time, date, and place of a hearing shall be correctly conveyed. Failure of a party to receive written notice shall not invalidate subsequent action. If questions arise at the hearing regarding the adequacy of notice, the decision-making body shall make a formal finding as to whether there was substantial compliance with the notice requirements of this Land Use Code

h. Table 7-5-C Notice Requirements

<b>Table 7-5-C: Notice Requirements</b>				
<b>X - Denotes Required Notice</b>				
<b>Procedure</b>	<b>Section</b>	<b>Published</b>	<b>Mailed</b>	<b>Posted</b>
Rezone and Initial Zoning	7-5-D-1	X	X	X
Annexations	7-10	X	X	X
Conditional Use Permits	7-5-D-3	X	X	X
Variances	7-5-D-4	X		X
Preliminary Planned Unit Development	7-5-D-5-j	X		X
Site Development Permit	7-5-D-2			
<b>Subdivisions</b>				
Lot Splits – 2 lots max	7-5-D-5-f			

Amended Plat (text amendment)	7-5-D-5-h			
Minor Subdivision	7-5-D-5-i			
Major Subdivision Sketch Plan	7-5-D-5-j	X		X
Major Subdivision Preliminary Plat	7-5-D-5-j	X		X
Major Subdivision Final Plat	7-5-D-5-j			
Vacation of ROW		X	X	X
Major Subdivision Sketch Plan	7-5-D-5-c			
Replats (Boundary Adjustments)	7-5-D-5-g			
Condominium/Townhouse Plat	7-5-D			X
Vested Rights	7-5-C-8			

4. Decision and Findings

a. Approval Criteria

To approve a development application, the respective board, commission, or Administrator shall find that the development application has satisfied and followed the applicable requirements of this section and all the approval criteria required for the applicable development application.

b. Decision

After consideration of the development application, the Staff Report, comments received from other reviewers (if applicable), and the evidence from the public hearing (if applicable), the decision-maker designated in [Table 7-5-B](#) shall approve, approve with conditions, or deny the application based on the applicable approval criteria. The Administrator shall provide written notification of the decision to the applicant within seven (7) days after the decision.

c. Conditions of Approval

Unless otherwise specified in this Land Use Code, the respective board or commission may impose such conditions on the approval of the application as may be necessary to reduce or minimize any potential adverse impact upon other property in the area, or to carry out the general purpose and intent of the adopted [Master Plan](#), other adopted City plans, and this Land Use Code. In such cases, any conditions attached to approvals shall be directly related to the impacts of the proposed use or development and shall be roughly proportional in both nature and extent to the anticipated impacts of the proposed use or development. No conditions of approval shall be less restrictive than the requirements of this Land Use Code, except where the Land Use Code allows deviations from the express requirements of the Land Use Code.

d. Findings

All decisions shall include at the least the following elements:

- i. A clear written statement of approval, approval with conditions, or denial, whichever is appropriate; and
- ii. A clear statement of the basis upon which the decision was made, including specific written findings of fact with reference to the relevant standards of this Land Use Code.

5. Record of Proceedings

a. Recording of Public Hearing

The respective board or commission conducting the [public hearing](#) shall record the public hearing by any appropriate means. A copy of the public hearing record may be acquired by any

person upon application to the Administrator, and payment of a fee to cover the cost of duplication of the record.

b. The Record

- i. The record shall consist of the following, all of which shall be kept by the City for a length of time prescribed in the City’s adopted records retention schedule:
- ii. All exhibits, including, without limitation, all writings, drawings, maps, charts, graphs, photographs, and other tangible items received or viewed during the proceedings;
- iii. All minutes of the proceedings; and
- iv. If available, a transcript and/or videotape recording of the proceedings.

c. Recording of Decisions

Once approved, and after the appeal period has expired, the decision shall be filed with the City Clerk.

6. Amendments to Permits or Other Forms of Approval

a. Minor Amendments

- i. Unless otherwise specified in this Section, minor amendments to any permit or other form of approval issued by the Administrator, the Planning Commission, or the City Council may be approved, approved with conditions, or denied administratively by the Administrator and may be authorized without additional public hearings. Such minor amendments may be authorized by the Administrator if the development approval, as so amended, continues to comply with the standards of this Land Use Code, at least to the extent of its original compliance (so as to preclude any greater deviation from the standards of this Land Use Code by reason of such amendments). Minor amendments shall consist of any of the following:
  - ii. Any change to any permit or other form of approval that was originally subject only to administrative review and was approved by the Administrator, provided such change would not have disqualified the original application from administrative review had it been requested at that time; and provided that the minor amendment does not result in an increase of more than ten percent in the amount of square footage of a land use or [structure](#) and does not result in a change in the types of [uses](#) in the project.
  - iii. Any change to any permit or other form of approval that was originally subject to final review by and was approved by the Planning Commission, provided that:
    1. The amendment maintains the design intent or purpose of the original proposal;
    2. The amendment does not change vehicular access points or increase anticipated peak hour vehicle trips by more than five percent;
    3. The [site](#) area is not expanded, and gross [floor area](#) is not increased by more than five percent;
    4. The amendment results in no major adverse environmental or land use impacts;
    5. All conditions of the prior approval are met.

b. Major Amendments

i. Amendments to any permit or other form of approval that are not determined by the Administrator to be minor amendments under Section 7-5-C shall be deemed major amendments. Major amendments shall be reviewed and processed in the same manner as required for the original application for which the amendment is sought.

c. Lapse of Approval

i. Site development review approvals shall terminate five years from the effective date of approval unless a Building Permit has been issued. The approval of the site development review may be extended for up to one year at the discretion of staff upon written notification filed with the City within the last six months before the five-year approval period has expired.

d. Subsequent Applications

i. Following denial of an application, the respective Board or Commission shall not consider the same or substantially the same application within one year of the date of denial. The respective Board, Commission, or Administrator may waive the one year waiting period if, after review of a written request, shows good cause. The respective Board or Commission must approve this waiver by an affirmative vote of the majority of its members.

7. Appeals

a. Purpose

This Section sets forth the process for appealing final decisions made under this Land Use Code. Appeals of land use decisions are available at each step of review and decision-making process. Administrative decisions may be appealed to the City Council, except for administrative approvals of minor [site plans](#), [temporary use](#) permits, sign permits, and final [subdivision plats](#). Decisions of the Planning Commission may be appealed to the City Council, as further set forth in this Section.

b. Types of Appeals

i. Appeals from Final Decisions by the Administrator

1. A party-in-interest may appeal a final decision made by the Administrator in administrating or interpreting this Code. All such appeals shall be taken to the Planning Commission, except those appeals from the Administrators decisions on temporary use permits, minor site plans, sign permits, and final subdivision plats shall be taken to either the Planning Commission or City Council, as applicable.

ii. Appeals from Final Decisions by the Planning Commission

1. A party-in-interest may appeal a final decision made by the Planning Commission to the City Council.

iii. Appeals from Final Decisions by the City Council

1. A party-in-interest may appeal a final decision made by the City Council to a Colorado court of competent jurisdiction.

iv. Appeals from Enforcement Actions

1. Appeals from issuance of a notice of violation or stop work order shall be taken to a Colorado court of competent jurisdiction.

c. Grounds for Appeal

i. The permissible grounds for appeal shall be limited to allegations that the Approval Authority committed one (1) or more of the following errors:

1. Failed to properly interpret and apply relevant provisions of this Code.
2. Failed to conduct a fair hearing in that:
3. The Original or Appellate Approval Authority abused its discretion as contained in this Code;
4. The Original or Appellate Approval Authority substantially ignored its formally established rules of procedure resulting in a denial of procedural due process; or
5. The Original or Appellate Approval Authority based its decision on evidence which was substantially false or grossly misleading.

d. Notice of Appeal

i. Appeals shall be made within ten (10) days of the final decision which is the subject of the appeal. All appeals shall be filed in writing with City Clerk and shall include the reasons for the appeal.

e. Burden of Proof

i. Any final decisions of the Approval Authority shall be presumed to be correct. The appellant has the burden of proof to show that a preponderance of the evidence introduced before the Approval Authority supports the conclusion that the decision should be overturned.

f. Appeal Hearing

i. The Administrator shall schedule a [public hearing](#) on the appeal no later than sixty (60) days after the date the appeal was filed with the City Clerk. The appeal hearing may be extended up to ninety (90) days after the filing of the appeal if agreed to by both the Administrator and the appellant. Notice of the public hearing shall be published as required for the original decision.

g. Appeal Criteria

i. The City Council shall reverse, amend, or remand a decision upon a finding that at least one of the grounds for appeal set forth in Section 7-5-C-7-c occurred, and that the final decision being appealed was materially affected thereby.

h. Decision

i. Following the public hearing, the City Council may, in whole or in part, affirm, reverse, or amend the decision being appealed based on the appeal criteria set forth in Section 7-5-C-7-g herein, and to that end the City Council shall have all the powers of the Approval Authority. The City Council may also remand the matter back to the Approval Authority, as deemed appropriate, for further proceedings consistent with the Land Use Code. The final decision shall be stated in writing in the body's minutes as well as in a written order to be

delivered to the appellant and shall include specific findings of fact with specific reference to relevant standards as set forth in this Land Use Code.

i. Notification to Applicant

i. The Administrator shall provide notification of the final decision to the parties in the appeal within ten (10) days of the decision.

8. Vested Rights

a. Purpose

The purpose of this Section is to provide the procedures necessary to implement the provisions of Article 68 of Title 24, C.R.S., as amended.

b. Definition

i. For purposes of Article 68 of Title 24, C.R.S., a [site specific development plan](#) means a document that complies with all requirements of this Section and consists of one of the following:

1. A final [subdivision plat](#) approved pursuant to Section 7-5-D; or
2. A site plan approved pursuant to Section 7-5-D.

9. Notice and Hearing

a. To obtain a site specific development plan, the developer must seek from the City Council approval of the project at a public hearing conducted at the request of the landowner, which hearing follows the successful approval of the development at all other required stages of the development review process. The public hearing shall be preceded by written notice of such public hearing pursuant to Section 7-5-C-3. Such notice may, at the City's option, be combined with the notice required for any other required notice. At such public hearing, interested persons shall have an opportunity to be heard. Failure of the landowner to request such a hearing renders the approval not a "site specific development plan," and no vested rights shall be deemed to have been created.

10. Approval, Effective Date and Amendments

a. A site specific development plan shall be deemed approved upon the effective date of the approved plan. In the event amendments to a site-specific development plan are proposed and approved, the effective date of such amendments, for purposes of duration of a vested property right, shall be the date of the approval of the original site-specific development plan, unless the City Council specifically finds to the contrary and incorporates such finding in its approval of the amendment. The City Council may, by agreement with the developer, designate an approval other than the final development plan or final plat to serve as the site-specific development plan approval for a specific project.

11. Notice of Approval

a. Each map, plat, site plan, or other document constituting a site-specific development plan shall contain the following language: "Approval of this Plan may create a vested property right pursuant to Article 68 of Title 24, C.R.S." Failure of the map, plat, or site plan to contain this statement shall invalidate the creation of the vested property right. In addition, a notice describing the type and intensity of use approved, the specific parcel or parcels of property

affected, and stating that a vested property right has been created, shall be published once, not more than 14 days after approval of the site-specific development plan, in a newspaper of general circulation within the City.

12. Duration

a. A vested property right approved pursuant to this Section shall last a period of three (3) years, unless otherwise agreed upon by the City and the applicant.

13. Payment of Costs

a. In addition to any and all other fees and charges imposed by the City, the applicant for approval of a site-specific development plan shall pay all costs incurred by the City as a result of the site-specific development plan review, including publication of notices, public hearing, and review costs.

14. Other Provisions Unaffected

a. Approval of a site-specific development plan shall not constitute an exemption from, or waiver of, any other provisions of the Code pertaining to the development and use of property.

15. Limitations

a. Nothing in this Section is intended to create any vested property right, but only to implement the provisions of Article 68 of Title 24, C.R.S. In the event of the repeal of said state law or a judicial determination that said law is invalid or unconstitutional, this Section shall be deemed to be repealed, and the provisions hereof no longer effective.

**D. Specific Procedures and Approval Criteria**

**1. Amendments to the Official Zoning Map/Rezoning**

a. Purpose

i. Amendments to the Official [Zoning Map](#) may be made to reflect changes in zoned district boundaries or for creation of new [zone districts](#). Amendments to the zoning map are not intended to relieve hardships, nor to confer special privileges or rights to a person or [parcel](#), but instead to make adjustments to the Official Zoning Map that are necessary in light of changed conditions, public policy, annexations, or that are necessary to advance the general welfare of the City.

b. Procedure

i. Rezoning may be requested or initiated by the City, the Planning Commission, or the owner of any legal or equitable interest in the property or his representative. Rezoning requests shall follow the procedures outlined below.

1. Preapplication conference. Attendance at a preapplication conference is mandatory for an Applicant intending to submit an application for rezoning.

2. Submit Application. The [Applicant](#) shall submit a complete application on forms supplied by the City with all application fees and containing the following materials:

a. A site plan;

b. Other information to show compliance with Section 7-5-D; and

- c. A list of all property owners within 300 feet of property being proposed for rezoning.
- d. No fee or formal application is required for action initiated by the City or Planning Commission.

c. Criteria for Approval

- i. The amendment is consistent with the public health, safety, and welfare; and
  1. The amendment is in [substantial conformity](#) with the [Master Plan](#), or
  2. The existing zoning is erroneous, or
  3. Conditions in the area affected or adjacent areas have changed materially since the area was last zoned.

ii. The burden shall be on the Applicant to show that the criteria of this Subsection have been met. If the reviewing body determines that such criteria have not been met, the application shall be denied. The application may be granted upon conditions or limitations which the reviewing body determines are necessary in order to insure that the applicable criteria are met. Such conditions or limitations shall be provided to the Applicant, in writing, as part of the decision.

d. Protests

- i. Any owner of property affected by a proposed amendment to the Official Zoning Map may protest the amendment pursuant to the statutory requirements of C.R.S. Section 31-23-305.

e. Approval Actions

- i. The City Council shall approve a zoning map change by ordinance and the City Clerk shall prepare a new zoning map to reflect the approved changes. The new Official Zoning Map shall contain the date and number of the ordinance amending it, the date the map was amended to reflect each amendment and the initials of the person who checked and approved the change to the map.

## 2. Site Development Permits

a. The purpose of this Section is to establish site development standards applicable to site permits. All [development](#) subject to this Section shall comply with the standards of this Section and with the City's construction standards. Site planning is required to ensure that all sites within the community are designed, arranged, and developed in a safe, consistent, and efficient manner. The arrangement of functions, uses and improvements should reflect the natural capabilities and limitations of the site, as well as the characteristics and limitations of the adjacent property or properties. These standards are developed so every project consistently adheres to the same standards.

b. Site Activities Requiring Permit. A permit is required for the following activities:

- i. Non-residential construction.
- ii. Addition to an existing residential building that increases the gross [floor area](#) by more than 25%.
- iii. New Residential construction.
- iv. Grading, fill, or excavation involving 300 cubic yards or more.

c. Single Family, Accessory Dwelling Unit, and [Duplex](#) Dwelling Units - Criteria

d. Construction for one single-family residence or accessory [dwelling unit](#) will be reviewed through the building permit process and shall comply with provisions outlined in Section 7-5-D-2-e. Proposed single-family residences and accessory dwelling units must be reviewed and approved for site development prior to applying for a building permit.

e. Minimum Application Contents: Single Family and [Duplex](#) Dwelling Units

i. These [uses](#) require the completion of a site development plan drawn to scale (not less than 1":40' scale) clearly detailing the location of [structures](#) and required improvements listed below:

1. Existing and proposed [structures](#) located on the [site](#).
2. Installation of new, or repair of damaged, curb, gutter, and sidewalk along abutting [streets](#), except in subdivisions where it is not required by current [subdivision](#) regulations.
3. Driveways and required off-[street parking spaces](#), including landscaped areas, and maneuvering areas adequate to meet all applicable requirements. When six or more spaces are required, the required parking and maneuvering areas shall be paved.
4. Site drainage adequate to avoid damage or adverse effects to improvements, [structures](#), and property on and off the site, including adjacent properties.
5. All existing and proposed landscaping, including trees, shrubs, and groundcover subject to the minimum requirements found in Section 7-8-F.
6. Sidewalks and other provisions for pedestrians.
7. Above and below ground utilities.
8. All outdoor lighting fixtures, which shall be shielded so that the light source is not directly visible off the premises and meet International Dark-Sky Association standards.

f. Minimum Application Contents: [Multi-family](#) Dwelling Units, Lodging and Non-Residential Uses

i. These uses require the completion of a site development plan drawn to scale (not less than 1":40' scale) clearly detailing the location of [structures](#) and required improvements listed below:

1. Existing and proposed [structures](#) located on the [site](#).
2. Installation of new, or repair of damaged, curb, gutter, and sidewalk along abutting [streets](#), except in subdivisions where it is not required by current subdivision regulations.
3. Required off-[street parking spaces](#), including landscaped areas, and maneuvering areas adequate to meet all applicable requirements. When six or more spaces are required, the required parking and maneuvering areas shall be paved.

4. Site drainage adequate to avoid damage or adverse effects to improvements, structures, and property on and off the site, including adjacent properties.
5. In addition to the minimum standards contained in Subsection 7-8-F, landscaping shall meet the following requirements:
  - a. At least 50% of the linear [frontage](#) of the [site](#) abutting public [street](#) rights-of-way to a minimum width of 15 feet shall be landscaped, except to the extent such area is or will be lawfully covered by [buildings](#), unless the City approves an alternative plan as more effectively presenting a landscaped view from the abutting street rights-of-way; and
  - b. Inclusive of the above [frontage](#) requirement, landscaping shall be required in at least 20% of that part of the site not covered by buildings on sites proposed for residential use and at least 10% of that part of the site not covered by buildings on sites where non-residential uses will occupy more than 50% of the property, except for properties in the C-1 zoning district along Highway 550 between Fourth and Ninth Avenues.
  - c. Such landscaping shall consist of trees, shrubs, and ground covers, and may include up to a maximum of 20% coverage in inert materials such as decorative paving stones, lava rock, pea gravel, etc., except to the extent such area is lawfully covered by a [building](#).
6. In addition, parking areas with 25 or more spaces or more than one aisle, shall incorporate landscaped islands disbursed throughout the parking with areas totaling a minimum of 6% of the parking area.
7. Driveways, culverts, and curb cuts.
8. All outdoor lighting fixtures shall be shielded so that the light source is not directly visible off the premises and meet International Dark-Sky Association standards.
9. Sidewalks and other provisions for pedestrians.
10. Trash collection and snow storage areas.
11. Above and below ground utilities.
- g. Supplemental Site Development Standards for Properties on Highway Corridors. Any property that is adjacent to the right-of-way line of Highway 550 and north of the intersection of Highway 550 with Skyrocket Creek as shown on the Official Zoning Map is also subject to Supplemental Site Development Standards listed below and must be detailed on the site plans:
  - i. Exterior mechanical equipment, including electrical transformers, shall either be incorporated in the overall form or design of the building or screened from view from any [street](#) by materials consistent with the landscaping of the property, the style of the main [building](#), any applicable Code adopted by the City in Chapter 6 of the City Code, and to protect the public health, safety, and welfare.
  - ii. Refuse collection containers and areas shall be screened from view from any [street](#) or residential area by materials consistent with the landscaping and [building](#).

- iii. Landscaping shall be installed and maintained to a minimum depth of 15 feet along 100% of the [frontages](#) adjacent to U.S. Highway 550, excluding driveways and sidewalks.
  - iv. Landscaping shall be installed and maintained to a minimum depth of 15 feet along a minimum of 25% of the secondary street frontages, excluding driveways and sidewalks.
  - v. The regulations of this Subsection shall apply to the entire building, [lot](#), [parcel](#) or contiguous [lots](#) or [parcels](#) which constitute a single site, when any part thereof is contiguous to the right-of-way of U.S. Highway 550 or secondary street segments described above.
- h. Excavation, Fill or Grading Involving 300 Cubic Yards or More
- i. These excavations require the submission of items listed below:
    - 1. A site development plan drawn to scale (not less than 1":40' scale) clearly detailing the nature and extent of the proposed excavation, fill or grading, including finished [slopes](#), retainage, and drainage details.
    - 2. Details of estimated quantities and type of material export or import. This requirement may require an engineers' estimate if deemed necessary in the development standards or by staff.
    - 3. Details on excavation plans showing access routes and types of equipment to be utilized, hours of operation, and any anticipated impact to City streets.
    - 4. Engineered plans for structural retainage features.
    - 5. Evidence of a storm water retention plan and permit, or other State or Federal requirement, if applicable and required by staff.
    - 6. Details on seeding, revegetation, and erosion control plans.
    - 7. The rezoning is consistent with the stated purpose of the proposed zoning district(s);
    - 8. Facilities and services (including roads and transportation, water, gas, electricity, police and fire protection, and sewage and waste disposal, as applicable) will be available to serve the subject property while maintaining adequate levels of service to existing [development](#);
    - 9. The rezoning is not likely to result in significant adverse impacts upon the natural environment, including air, water, noise, storm water management, wildlife, and vegetation, or such impacts will be substantially mitigated; and
    - 10. The rezoning is not likely to result in significant adverse impacts upon other property in the vicinity of the subject tract.

### 3. Conditional Uses

- a. Purpose. [Conditional uses](#) are those land uses that are generally compatible with the [permitted uses](#) in a zone district, but that require site-specific review of their location, design, intensity, [density](#), configuration, and operating characteristics, and that may require the imposition of appropriate conditions, in order to ensure compatibility of the [use](#) at a particular location and mitigate its potentially adverse impacts.

b. Procedure. An Applicant requesting conditional use approval shall follow the procedures outlined below.

i. Preapplication conference. Attendance at a preapplication conference is mandatory for an Applicant intending to submit an application for conditional use permit.

ii. Submit Application. The Applicant shall submit a complete application on forms supplied by the City with all application fees and containing the following materials:

1. A site plan;
2. Other information to show compliance with the zoning district in which the conditional use is being proposed;
3. List of property owners within 300 feet of the property which is the subject of the application; and
4. Proof of mailing to property owners as required by Subsection 7-5-C-3.

c. Criteria for Approval. The Planning Commission may approve, approve with conditions, or deny the application. [Conditional uses](#) for the various zoning districts shall be permitted only if the Planning Commission determines, following a public hearing, that the following criteria are met with respect to the type of use requested by the Applicant:

i. The use will not be contrary to the public health, safety, or welfare;

ii. The use is consistent with the purposes, goals, objectives, and standards of the City's [Master Plan](#);

iii. The [use](#) complies with all other applicable requirements of the zone district in which it is proposed to be located;

iv. The location, size, design, and operating characteristics of the proposed [conditional use](#) minimizes adverse effects, including visual impacts, impact on pedestrian and vehicular circulation, parking, trash, service delivery, noise, light, vibrations, and odor on surrounding properties;

v. The [use](#) is compatible with existing uses in the area and other allowed uses in the zoning district;

vi. The use is consistent with the purpose of the zoning district in which it is proposed to be located; and

vii. The use will not have an adverse effect upon other property values or the use of adjacent properties.

1. The burden shall be on the Applicant to show that these criteria have been met. If the Planning Commission determines that such criteria have not been met, the application shall be denied. The application may be approved upon conditions or limitations that the Planning Commission determines are necessary in order to ensure that the applicable criteria are met.

d. Issuance and Termination of the Permit

- i. If the Planning Commission approves or approves with conditions the application for the conditional use, City Staff shall issue a conditional use permit. If applicable, the conditional use permit shall include all conditions on the permit approved by the Planning Commission.
- ii. A conditional use permit shall automatically terminate upon a change in the permittee or majority change in the ownership of a permittee if the permittee is an entity. No conditional use permits, including those permits issued prior to the adoption of this Code, shall terminate upon conveyance of the property unless the permittee also changes as described in this subsection. If the conditional use is discontinued for 12 consecutive months, the permit shall terminate immediately.
- iii. If the terms of a conditional use permit are violated by the holder of the permit, upon a referral from City Staff, Planning Commission shall hold a public hearing on the alleged violation. The public hearing shall be held in conformity with the public hearing provisions of this Section.

#### 4. Variances

- a. Purpose. [Variances](#) are deviations from the dimensional requirements, design or performance standards and other provisions of the OLC, not related to use of the property, that would not be contrary to public interest when, owing to special circumstances or conditions, the literal enforcement of the provisions of this Chapter would result in undue and unnecessary hardship. Variances shall only be granted in accordance with the terms of this Subsection.
- b. Procedure. An Applicant requesting variance approval shall follow the procedures outlined below:
  - i. Preapplication conference. Attendance at a preapplication conference is mandatory for an Applicant intending to submit an application for variance application.
  - ii. Submit Application. The Applicant shall submit a complete application on forms supplied by the City with all application fees and containing the following materials:
    1. A site plan and
    2. Other information to show compliance with Section 7-5-D-4-c.
- c. Criteria for Approval. The Planning Commission may approve, approve with conditions, or deny the application, continue the public hearing, or remand it to the Applicant with instructions for modification or additional information or action. Planning commission may approve a variance if it finds that all of the following criteria are met:
  - i. The grant of variance will be generally consistent with the purposes, goals, objectives and policies of the City's [Master Plan](#) and the OLC;
  - ii. The grant of variance is the minimum variance that will make possible the reasonable [use](#) of the [parcel](#), [building](#) or [structure](#); and
  - iii. Literal interpretation and enforcement of the terms and provisions of the OLC would deprive the Applicant of rights commonly enjoyed by other parcels in the same zoning district and would cause the Applicant unnecessary hardship, as distinguished from mere inconvenience. In determining whether an Applicant's rights would be deprived, the Planning Commission shall consider whether either of the following conditions apply:

1. There are special conditions and circumstances that are unique to the parcel, building or structure, that are not applicable to other parcels, structures, or buildings in the same zone district and that do not result from the actions of the Applicant; or
2. Granting the variance will not confer upon the Applicant any special privilege denied by the City's Master Plan and the terms of the OLUC to other parcels, buildings, or structures, in the same zone district.

d. Issuance, Voting, Expiration and Extension of Variances. The burden shall be on the Applicant to show that these criteria have been met. If the Planning Commission determines that such criteria have not been met, the application shall be denied. The application may be approved upon conditions or limitations which the board determines are necessary in order to insure that the applicable criteria are met. Such conditions or limitations shall be provided to the Applicant and interested parties, in writing, as part of the decision.

i. No variance shall be granted with less than four (4) concurring votes of the Planning Commission.

ii. The Planning Commission shall announce its decision within 35 days of the completion of the hearing. Any decision on a variance application shall be in writing by Resolution. The decision of the board with respect to an application for a variance shall be final, subject only to review by certiorari in the courts. The City shall also have the right to appeal any such decision to the courts. Upon the filing of an appeal or request for review in the courts, the City shall cause a transcript of any tape recording of the hearing to be made and certified to the court, and the party filing such appeal, or such review shall pay the City the reasonable cost incurred in producing such transcript, unless such party has a transcript produced by a court reporter at his expense.

iii. Expiration and Extension of Variances

1. Expiration. All variances shall expire 12 months from the date of issuance if no building permit has been issued to establish the variation authorized, or if the variation does not require a building permit, unless the variation is established, ongoing, and in operation. Such time period shall not be altered by transfer of ownership.

2. Extension. Upon written request, the Planning Commission may grant an extension of the variance for a period not to exceed 6-months for good cause shown. No request for an extension shall be considered unless a written application requesting the extension is submitted to the Community Development Director prior to the date the variance is to expire. Failure to submit an application for an extension within the time limits established in this section shall render the variance null and void. In considering an extension to a previously-approved variance, the Community Development Director shall consider if any changes have been made to the character of the variance application and resulting criteria for decision. If no changes have been made and the [variance](#) extension request was filed before expiration, the Community Development Director shall issue an extension not to exceed 6-months for good cause shown.

## 5. Subdivisions

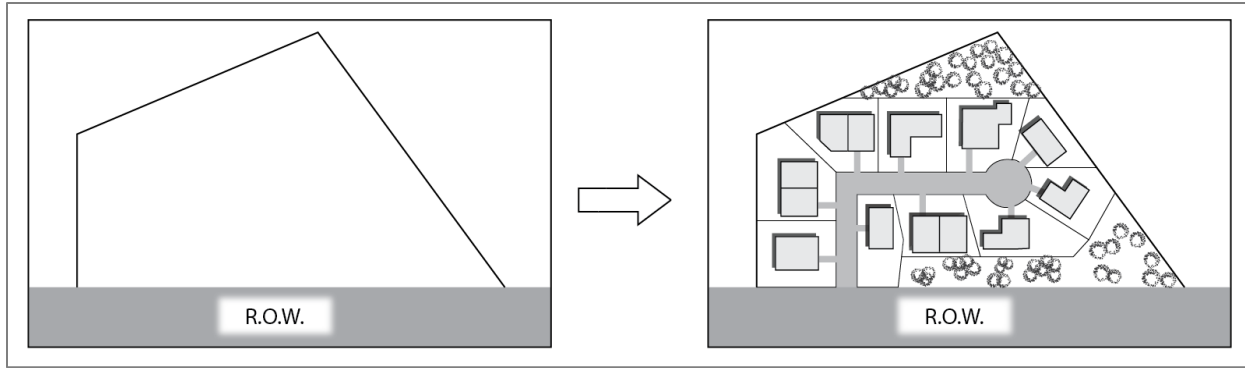

**a. Purpose**

i. Subdivision development regulations are essential for orderly and controlled development within, and adjoining, the City of Ouray. These regulations ensure development is consistent with community plans and constructed to established and required standards. These standards also ensure quality, safety and the overall welfare of property owners, and citizens or customers who use or frequent these developments. Quality development should benefit everyone.

**b. General Provisions**

i. Control

1. All development plans or proposals shall be subject to the provisions of these regulations, whether a plat is filed or not.
2. All [final plats](#) required by this Section shall be filed and recorded following approval by City Council and after any conditions have been met.

ii. Jurisdiction

1. These regulations are applicable within the following areas:
  - a. All [land](#) located within the legal, corporate boundaries of the City of Ouray.
  - b. Where applicable, any quasi-municipal corporation located partially or entirely within its boundaries pursuant to Section 18(2)(a) and 2(b) of Article XIV of the Colorado Constitution.

iii. Liability

1. These regulations shall not create any liability on the part of the City or any officer or employee thereof arising from reliance upon these regulations or any administrative act or failure to act pursuant to these regulations.

iv. Applicability

1. These regulations also apply to [Planned Unit Developments](#) which may be considered and processed in accordance with Section 7-5-D-5-j.

v. General Procedures

1. The procedures of this Section, Common Development Review Procedures Section 7-5-C, and the standards in Section 7-9. Subdivision Design and Improvements, shall apply to all subdivisions that result in the portioning, dividing, combining, or altering of any lot, parcel, or tract of land, including subdivisions created by an exercise of the power of

eminent domain by an agency of the State or City, unless specifically excluded by state law.

**c. Sketch Plan**

i. Purpose. The [sketch plan](#) is an optional step to consider general conformity with the [Master Plan](#), Codes and Standards and these regulations. It allows for an evaluation of a proposed [subdivision](#) before detailed planning and engineering work has been undertaken and before substantial expenses have been incurred.

ii. Approval Criteria. The Planning Commission shall review the Sketch Plan to determine its general acceptability, consistence with the City Standards and will consider the following minimum criteria:

1. Conformity with the Master Plan and zoning regulations.
2. Relationship of development to topography, soils, drainage, flooding potential, natural hazard areas and other physical characteristics.
3. Availability of water, means of sewage collection and treatment, access and other utilities and services.
4. Compatibility with the environment, vegetation, and unique natural features.
5. Compatibility with the architectural history.

iii. As part of the [Sketch Plan](#) approval, the Planning Commission may recommend waiving the [preliminary plat](#) requirement for subdivisions if the [development](#) does not require public improvements or other critical and necessary improvements. The City Council will consider the Planning Commission’s recommendation within thirty (30) days and determine whether a waiver of preliminary plat requirements is warranted.

**d. Preliminary Plat**

i. The City may have the [preliminary plat](#) and supporting documentation and reports reviewed by registered professionals for conformance with City Standards and regulations. Fees associated with these reviews must be paid by the applicant. Additional review time may be required in these cases.

ii. The preliminary plat and supporting documentation consider during the review and approval process must be stamped "approved" accordingly or identified as approved documentation. All revised plans must also be included and plans or reports with professional stamps or approvals must also be identified as approved documentation.

iii. Decision Criteria

1. Conformity with the [Master Plan](#) and zoning regulations.
2. Relationship of development to topography, soils, drainage, flooding potential, natural hazard areas and other physical characteristics.
3. Availability of water, means of sewage collection and treatment, access and other utilities and services.
4. Compatibility with the environment, vegetation, and unique natural features.
5. Compatibility with the architectural history.

6. Compliance with all subdivision design criteria in the code
  7. Compliance with all standards of the applicable zoning district.
- iv. After approval of the preliminary plat and prior to commencement of construction, the applicant and City public works staff shall cooperatively schedule a pre-construction meeting and invite all affected utility companies' representatives to said meeting. The applicant is responsible for ensuring contractor(s) and associate employees/staff attend said meeting.
  - v. After the pre-construction meeting, and upon submittal and approval of completed submittals and required fees and payment described above, the City shall then issue a notice to proceed, and the applicant may commence construction of subdivision improvements.
  - vi. Building permits may be issued for any property within the development that has been considered and approved during the preliminary plat review process, and that has adequate infrastructure installed to serve the building during the construction phase. The building permit applicant must be the property owner of record. No certificate of occupancy shall be issued until a [final plat](#) is approved and recorded.

**e. Final Plat**

- i. Following the [preliminary plat](#) review and approval, the applicant shall submit a [final plat](#) containing the information specified in Subsection 7-5-D-5-d.
- ii. Decision Criteria
  1. Compliance with all subdivision design criteria in the code.
  2. Compliance with all plat standards.
  3. Compliance with all applicable conditions of preliminary plat approval. The applicant may seek a waiver of a condition from City Council prior to the final plat being considered by Planning Commission.
- iii. The final plat shall be submitted within one (1) year after approval of the preliminary plat, otherwise, the preliminary plat approval shall become null and void unless an extension of time is applied for and granted prior to the expiration of the preliminary plat. No final plat shall be approved if submitted beyond two (2) years of approval of a related preliminary plat, except if a phased final plat as described in subsection (c).
- iv. The applicant may seek final plat approval for a portion of the approved preliminary plat. Submittal and approval of each phase of a final plat will result in a one (1) year extension for the applicant to seek final plat approval of the remaining approved preliminary plat. However, the last phase of final plat approval must be submitted no later than five (5) years after the approval of the preliminary plat. Such an extension does not require approval by Planning Commission.
- v. The administrator shall consider the final plat and supporting documentation within 30 days of a complete submittal. The final plat should not be signed by City Staff or recorded

until all conditions are satisfied, except if the conditions are part of a [Subdivision Improvements Agreement](#).

vi. No final plat shall be approved until all of the improvements required by these subdivision regulations have been installed, inspected, and approved, or a subdivision improvements agreement with security has been provided in accordance with provisions of Subsection 7-9-E of these regulations. The final plat shall be recorded with the County Clerk and Recorder, following approval by City administration. The recorded final plat shall be the original plat complete with all signatures, dates, and other information. An electronic copy of the recorded [plat](#) shall be supplied to the City. All recording and filing costs are to be paid by the applicant.

vii. No land shall be subdivided, nor any subdivided [lot](#) or [parcel](#) be sold or conveyed until a [final plat](#) has been approved and recorded in accordance with this Subsection.

#### f. Lot Splits

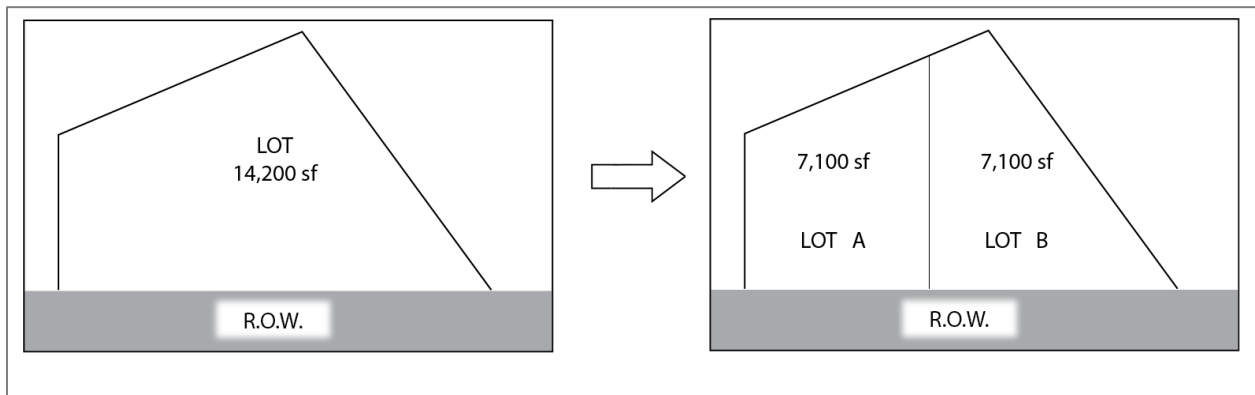

i. A lot previously created by a subdivision plat which has been approved and accepted by the City, and recorded in the Ouray County Records, may be subdivided into no more than two lots if the criteria of this Subsection is fulfilled and City approval is granted.

ii. The following may apply for an allowable lot split:

1. Any parcels created by the split, whether consisting of separately described lots, or parts of lots, shall comply with the minimum design standards of these regulations for lots, and with the applicable dimensional requirements of the City Zoning Regulations.
  - a. The deed or other instrument creating the split shall reserve and be subject to existing easements.
2. A property owner or representative seeking to split a lot by deed or other instrument, shall submit an application in conformance with all procedures of this code.
3. City staff may require an improvements survey to be submitted if necessary to determine if the criteria of this subsection have been met prior to consideration by the City administration.

4. The lot split shall be recorded with the County Clerk and Recorder, following approval by the City. An electronic copy of the recorded plat shall be supplied to the City. All recording and filing costs are to be paid by the property owner or representative.

**g. Replat/Boundary Adjustments/Lot Consolidation**

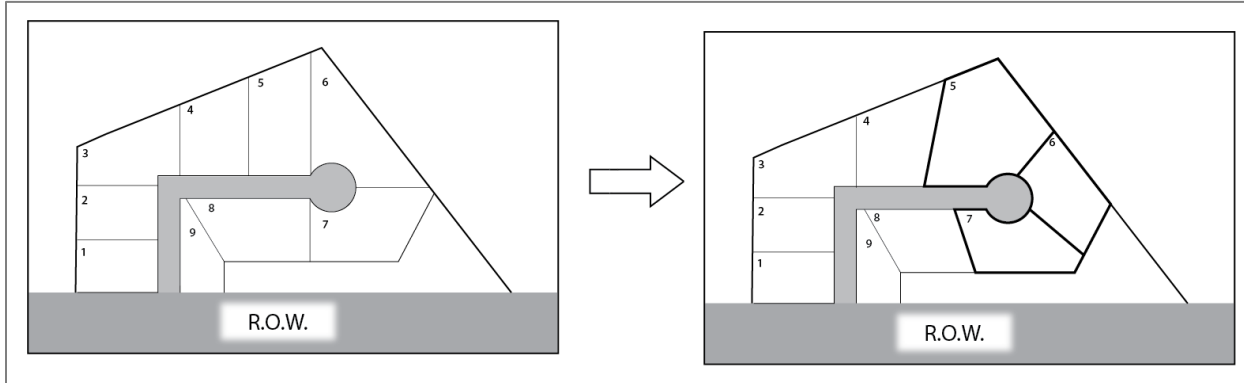

- i. Replats which reduce the number of separately described contiguous parcels or move a boundary line may be approved and recorded pursuant to this Subsection in lieu of other procedures for subdivisions provided in these regulations.
- ii. Application and Procedure. No preapplication conference is required. An application and submittal requirements may be obtained from the Community Development Department. Replats are reviewed and decided administratively. Administrative decisions may be appealed to the Planning Commission per §7-5 H of the Ouray Municipal Code.
- iii. Staff will review the application and submitted items notifying the applicant of completeness within 15 days of submittal.
- iv. All decisions on replats shall be made within 30 calendar days of a determination of application completeness. Any period during which the applicant has been requested by the City to correct plans, perform required studies, provide additional required information, or otherwise requires the applicant to act shall be excluded from the 30-day time period. The period shall be calculated from the date the City notifies the applicant of the need for additional information until the date all the requested information has been provided to the City.
- v. Decision Criteria.
  1. None of the lots affected will be made substandard with respect to the requirements for lot size and dimensions, as required under the respective zoning district, as part of the Ouray Municipal Code. An existing lot, or parts of an existing lot, may be consolidated into the adjoining lots providing no substandard lot is created; and
  2. No existing [building](#) or [structure](#) is made substandard or nonconforming; and
  3. Existing easements are not jeopardized or rendered impractical to serve their intended purpose; and
  4. The lots being adjusted are considered buildable lots that can accommodate a legal structure under the zoning standards in place at the time of application.

vi. Recording. Following approval by City administration, the replat shall be recorded with the County Clerk and Recorder. No plat shall be recorded or signed by City staff until all conditions associated with approval have been satisfied. An electronic copy of the recorded plat shall be supplied to the City. All recording and filing costs are to be paid by the property owner or representative.

**h. Amended Plat**

i. Amended [subdivision plats](#) previously approved by the City, or parts of such plats, may be approved and recorded in accordance with the provisions of this Subsection in lieu of other procedures provided for subdivisions by these regulations.

ii. Decision Criteria.

1. Amendments shall conform to the requirements for [final plats](#) Subsection 7-5-D-5-e; and
2. Minimum design standards and dimensional requirements shall be met; and
3. Existing easements and/or public improvements are not jeopardized or rendered impractical to serve their intended purpose; and
4. All conditions of approval for the previous plat are complied with unless specifically brought out and modified with the amendment.

iii. Recording. Following approval by the City, the amended plat shall be recorded with the County Clerk and Recorder. No plat shall be recorded or signed by City staff until all conditions associated with approval have been satisfied. An electronic copy of the recorded plat shall be supplied to the City. All recording and filing costs are to be paid by the property owner or representative.

**i. Minor Subdivisions**

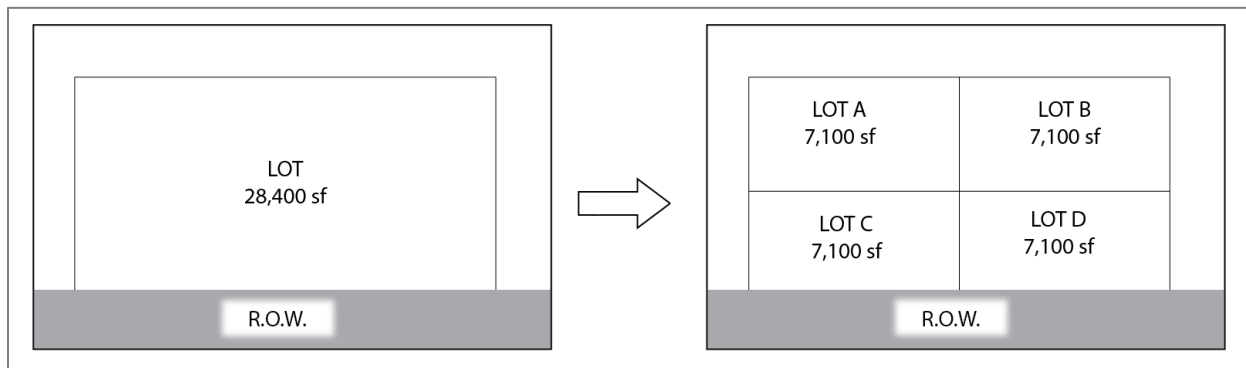

i. Subdivisions resulting in 4 or less new [lots](#), which have available all required improvements and comply with the design standards of Section 7-9-C, shall be exempt from the requirements for a preliminary plat, unless otherwise required by the Planning Commission.

ii. Decision Criteria

1. Conformity with the [Master Plan](#) and zoning regulations.
  2. Relationship of [development](#) to topography, soils, drainage, flooding potential, natural hazard areas and other physical characteristics.
  3. Availability of water, means of sewage collection and treatment, access and other utilities and services.
  4. Compatibility with the environment, vegetation, and unique natural features.
  5. Compatibility with the architectural history.
  6. Compliance with all [subdivision](#) design criteria in the code.
  7. Compliance with all standards of the applicable zoning district.
- iii. The [plat](#) shall be recorded with the County Clerk and Recorder, following approval by the City. An electronic copy of the recorded plat shall be supplied to the City. All recording and filing costs are to be paid by the property owner or representative.

**j. Planned Unit Developments – Major**

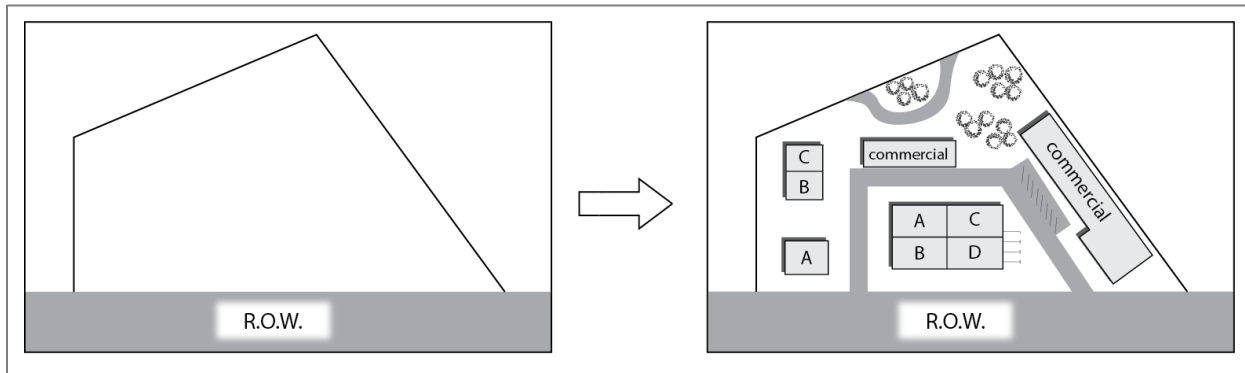

- i. Statement of Objectives of [Development](#). The intent of this section is to promote the [Planned Unit Development](#) Act of 1972 and encourage innovative developments with unique and valued community attributes. PUDs allow for consideration of development proposals that differ from required development improvements identified in the OLUC. PUDs offer different options to the applicant when planning and obtaining City approval for their development. PUDs allow flexibility with respect to dimensional requirements and increased densities under certain conditions or circumstances. PUDs encourage conservation of a site's natural characteristics, innovative residential, commercial and industrial development plans which will result in a more efficient use of [open space](#) and provide [affordable housing](#) for year around residents.
- ii. Criteria for a [Planned Unit Development](#) (PUD). A PUD shall be in general conformity with the City's [Master Plan](#) and consistent with the objectives as stated in Subsection (i) above.
- iii. Compliance with the Colorado Planned Unit Development Act of 1972.
  1. A PUD shall have a minimum of 1 unit or lot.

iv. Permitted Uses

1. Recreational Facilities and "permitted" and "[conditional uses](#)" in the zone or zones in which the PUD is located shall be permitted when approved as part of the Planned Unit Development.
2. Residences may be clustered into [duplexes](#) or multi-family residences.

v. Dimensional Requirements and Densities

1. The dimensional requirements for various PUD items may differ from what is required in the OLUC if the Planning Commission determines that such deviations will promote the public health, safety and welfare.
2. Residential PUDs may have additional residential units for each acre in the PUD, above what would be allowed otherwise in the zoning district or districts involved.

vi. Procedures

1. Planned Unit Developments (PUD) shall be reviewed in accordance with the same procedures for review of subdivisions as found in Subsection 7-5-D-5.
2. The preliminary and final PUD plan shall comply with all requirements for a preliminary and final [subdivision plat](#), to the extent applicable.
3. A public notice of the hearing on the preliminary planned development plan and any substantial amendments thereto, shall be given by publishing a notice and posting a notice on the property in accordance with noticing procedures outlined in Section 7-5-C.
4. Required Improvements and Standards
  - a. PUD plans shall comply with design standards in Subsection 7-9-C and provide construction improvements as required for subdivisions in Subsection 7-9-E, unless granted otherwise by the Planning Commission.
  - b. PUD development improvement agreements and required securities must comply with Subsection 7-9-E.

**k. Planned Unit Developments – Minor**

- i. A minor Planned Unit Development shall be any proposed planned unit development proposed for less than 4 residential [dwelling units](#). Criteria for a Minor Planned Unit Development (PUD). A Minor PUD shall be in general conformity with the City's [Master Plan](#) and consistent with the objectives as stated in Subsection (i) above.
- ii. Compliance with the Colorado Planned Unit Development Act of 1972.
  1. A PUD shall have a minimum of 1 unit or [lot](#).
- iii. Permitted Uses

1. Recreational Facilities and "permitted" and "[conditional uses](#)" in the zone or zones in which the PUD is located shall be permitted when approved as part of the [Planned Unit Development](#).

2. Residences may be clustered into [duplexes](#) or multi-family residences.

iv. Dimensional Requirements and Densities

1. The dimensional requirements for various PUD items may differ from what is required in the OLUC if the Planning Commission determines that such deviations will promote the public health, safety and welfare.

2. Residential PUDs may have additional residential units for each acre in the PUD, above what would be allowed otherwise in the zoning district or districts involved.

v. Procedures

1. Minor Planned Unit Developments (PUD) shall be reviewed in accordance with the same procedures for review of minor subdivisions as found in Section 7-5-D-5-i.

2. The minor PUD plan shall comply with all requirements for a preliminary and final [subdivision plat](#), to the extent applicable.

3. A public notice of the hearing on the minor planned development plan and any substantial amendments thereto, shall be given by publishing a notice and posting a notice on the property in accordance with noticing procedures outlined in Section 7-5-C-3.

4. Required Improvements and Standards

a. PUD plans shall comply with design standards in Subsection 7-9-C and provide construction improvements as required for subdivisions in Section 7-9-E, unless granted otherwise by the Planning Commission.

b. PUD development improvement agreements and required securities must comply with Subsection 7-9-E.

**6. Condominiumization**

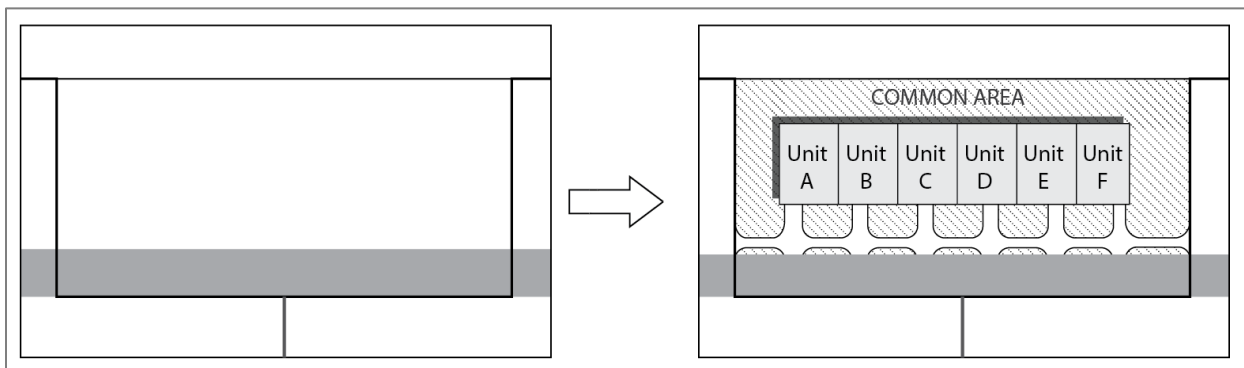

a. Purpose

Where a proposed development is to include a condominium form of ownership or if an existing development is to be converted to a condominium form of ownership, in whole or in part, an application shall be submitted for review and approval as a subdivision pursuant to Section 7-5-D-5 and pursuant to the additional terms and provisions of this Section.

b. Condominium Documents

Prior to review by the Planning Commission of any plat, the owner of the property being dedicated shall fully execute and cause to be properly acknowledged a declaration prepared in compliance with the purpose, intent and requirements of the Colorado Common Interest Ownership Act. The declaration shall also contain the following:

- i. A provision for the ultimate obligation by the condominium association to pay all water and sewer charges for all individual units within the project, and any common element charges in accordance with the rules and regulations of this Code.
- ii. A clear definition and description of the rights, duties and liabilities of all unit owners with respect to the general common elements and the limited common elements.
- iii. In the event the condominium project is expandable, appropriate provisions relating to the phasing of the project, along with the identification, by legal description, of the property onto which the project will be expanded, identification of the total maximum number of units which could be constructed within the entire expanded project, and identification of the interest each unit owner will have, by percentages, after any expansion.
- iv. A provision that, in the event any unit is owned by more than one (1) person or by a partnership, joint venture, corporation or other such entity, the owners thereof shall designate, in writing to the association, the name and address of the agent of the owner to whom all legal or official assessments, liens, levies or other such notices may be properly and lawfully mailed, and that, upon failure to so designate an agent, the association shall be deemed to be the agent for receipt of notices to such owners.

## Section 7-6 Zoning Districts

### A. Purpose

1. This Section divides the City into Zoning Districts of such number, shape, and area, of such common unity of purpose or use as are deemed most suitable to effectively accomplish the intent of the City’s [Master Plan](#). To manage land development, each Zoning District has a stated purpose, uses permitted by right, uses permitted by [conditional use](#) permits, dimensional limitations, and off-street parking requirements. All development within each Zoning District shall be consistent with the stated purpose for the Zoning District and any applicable overlay district.

### B. Zoning Map

1. The boundaries of the districts set out in this Section are shown on the 2021 Revised Zoning Map of the City, as adopted by Ordinance No.12 (Series 2021), as may be amended from time to time and is made part of this Code.
2. A copy of the Official Zoning Map, as amended from time to time, shall be maintained in the City Clerk’s office available for public inspection.
3. Amendments to the Official Zoning Map may be made by an ordinance enacting a revised map or by an ordinance amending portions of the Official Zoning Map by specifying the description of the property to be rezoned. Amendments to the Official Zoning Maps shall be governed by the procedures in Subsection 7-5-D-1.
4. The regulations for the various districts provided for in this Section shall apply within the boundaries of each, as such district is indicated on the Official Zoning Map.
5. The district boundaries, as shown on the Official Zoning Map, shall be construed to follow the center lines of [streets](#) or [alleys](#), to follow platted [lot](#) lines or the lines of undivided [parcels](#) of property, or to follow the [City](#) limits, whenever a boundary is shown as approximately in the vicinity of such lines. The scale of the map may determine distances.

### C. Establishment of Districts

1. This Section establishes the zoning districts and contains basic information pertaining to the districts, including statements of purpose. Section 7-7, Use Regulations, and Section 7-8, Dimensional Standards, identify the [uses](#) allowed within the districts and the dimensional standards applying to [development](#) in the districts, respectively. Section 7-8 , Development Standards, identifies any district-specific development standards applying to development in the districts. The following zoning districts are established:

<b>Table 7-6-C: Establishment of Districts</b>	
<b>Zoning District</b>	<b>Abbreviation</b>
<b>Parks – Developed</b>	<b>P-1</b>
<b>Parks – Conservation</b>	<b>P-2</b>
<b>Residential</b>	<b>R-1</b>
<b>Residential – High Density (N/S of Skyrocket)</b>	<b>R-2</b>
<b>Commercial</b>	<b>C-1</b>
<b>Commercial – Industrial (N/S of Skyrocket)</b>	<b>C-2</b>

**D. Purpose of Each Zoning District**

1. Parks Developed – P-1

a. The purpose of the Parks-Developed District (P-1) is to utilize and preserve [open space](#).

2. Parks Conservation- P-2

a. The purpose of Parks-Conservation District (P-2) is to preserve, in its natural state, certain designated park areas that have not been developed, except to allow parking or public water facilities.

3. Residential – R-1

a. The purpose of Residential District (R-1) is to accommodate non-transient residential [development](#) in single family [dwellings](#) and [duplexes](#).

4. Residential – High Density – R-2

a. The purpose of the Residential District – High [Density](#) (R-2) is to accommodate transient, part-time or permanent residential development in a density greater than envisioned for R-1.

5. Commercial – C-1

a. The purpose of the Commercial District (C-1) is to encompass the commercial business district of Ouray. It is intended to accommodate retail, office, service-based businesses, and residential and institutional uses consistent with a conventional business district.

6. Commercial – Industrial – C-2

a. This district encompasses lands along the Uncompahgre River and Highway 550 in the northern portion of the City of Ouray. It creates areas for housing, retail and wholesale businesses, tourist and auto oriented uses, storage, light manufacturing, and industrial activities. Each use will be required to mitigate its particular negative impacts determined to exist so as to provide for the reasonable enjoyment of adjacent properties.

**E. Overlay Districts**

1. Purpose

The purpose of the overlay districts below is to provide for additional standards and protections that protect the historic character of the city and allow for appropriate infill.

**a. Local and National Historic District**

i. On R1 and R2 properties within the boundaries of the Ouray Local and National Historic District as shown on Official Zoning Map, the maximum [floor area](#) gross shall not be more than 10% greater than the average floor area of primary [structures](#) on [lots](#) located on the block front or 4,260 sq. ft., whichever is less. Accessory buildings or structures shall be excluded from the average floor area calculation.

**b. Commercial Historic District**

i. C-1 and C-2 properties:

1. No minimum front or side [setback](#) (see Dimensional Requirements [Table 7-8-A](#)).

ii. C-1 properties:

1. On properties within the boundaries of the Ouray Commercial Historic District and fronting U.S. Highway 550, the maximum [floor area](#) shall be 9,585 sq. ft. per 25 ft. of U.S. Highway 550 [frontage](#) for the [lot](#) on which the building is located.
2. Any building on a [lot](#) located within the Ouray Commercial Historic District as shown on Official Zoning Map may not have more than 75% of the building's [ground floor](#) level devoted to a residential [dwelling unit](#) or residential spaces or [uses](#) accessory thereto.
3. Any buildings located on [lots](#) that front on U.S. Highway 550 and located within the Ouray Commercial Historic District between 5th and 8th Avenues may not devote any portion of the ground floor facade facing U.S. Highway 550 to residential dwelling units or spaces or uses accessory thereto, except for residential entryways.
4. No building shall be located within 10 feet of another building except for buildings located within the Ouray Commercial Historic District and buildings not used for residential purposes.

**Section 7-7 Use Regulations**

**A. Table of Allowed Uses**

Table 7-7-A: Table of Allowed Uses							
<b>P = Permitted Use</b>		<b>Blank Cell = Prohibited Use</b>					
<b>L = License Required</b>							
<b>C = Conditional Use</b>							
<b>Use Category</b>	<b>Use Type</b>	<b>R-1</b>	<b>R-2</b>	<b>C-1</b>	<b>C-2</b>	<b>P-1</b>	<b>P-2</b>
<b>Residential Use</b>							
Household Living	Dwelling - Single-Family	P	P	P	P		
	Dwelling - Duplex	P	P	P	P		
	Dwelling - Multi-Family		P	P	P		
	Dwelling - Modular		P	P	P		
	Dwelling - Manufactured, Mobile Home			P	P		
	Timeshares		C	C	C		
	Accessory Dwelling Unit (ADU)	P	P	P	P		
<b>Commercial Use</b>							
General	Retail Shop			P	P		
	Office - Professional, Business			P	P		
	Wholesale Distributors				P		
	Outdoor Displays of Merchandise			P	P		
	Marijuana - Sales, Centers, Retail, Operation, Cultivation						
Arts & Entertainment	Crafting of Art, Collectibles, Handicrafts			P	P		
	Theater			P	P		
	Adult Entertainment				C		
Food & Beverage Services	Bar, Tavern, Liquor Store			P	P		
	Restaurant		P	P	P		
	Fruit, Vegetable, Cider & Honey Sales				P		
	Accessory Bars & Restaurants for Lodging Business		P	P	P		
	Food Trucks			P	P		
Lodging Facilities	Lodging Business - Hotel, Motel, Bed & Breakfast, Hostel		P	P	P		
	Campground and RV park		C	C	C		
	Short Term Rental (STR)		L	L	L		
Offices, Business & Professional Services	Bank, Financial Institution			P	P		
	Professional, Government, or Administrative Office/Facility			P	P		
	Pet Boarding Kennels				C		

Automotive, Maintenance & Repair Services	Auto Service Stations					P		
	Repair Shops					P		
	Automotive Sales					P		
Storage & Warehousing	Lumber Yards					P		
	Storage Units					P		
	Builder Supply Yards					P		
	Wholesale Distributors					P		
	Warehousing					P		
	Intermodal Shipping Containers for Accessory Storage					C		
Tourist Oriented Uses	Jeep/OHV/snow machine or similar tours and rentals				C	C		
	Horse tours/boarding					C		
<b>Public, Institutional, Open Space and Civic Uses</b>								
Community & Cultural Facilities	Scenic Areas	P	P	P	P	P		
	Conservation Areas	P	P	P	P	P		
	Historic Preserves	P	P	P	P	P		
	Bird and Animal Sanctuaries	P	P	P	P	P		
	Public Utility Service Facilities	P	P	P	P	P	P	
	Public Sanitation Facilities							P
	Public Water facilities							P
	Private and Fraternal Clubs				P	P		
	Churches	P	P	P	P			
	Recreational Facility					P		
	Public Schools	P	P	P	P			
Transit Uses	Street & Highway Landscaping and Beautification	P	P	P	P	P		
	Parking Lots							P
Open Space	Agriculture Open Space						P	
	Open Space, Forest Parks, Tree Planting	P	P	P	P	P	P	P
<b>Light Industrial / Heavy Commercial</b>								
Industrial Uses	Gravel Crushing & Screening					C		
	Cabinet, Carpentry, Machine and Welding Shops					P		
<b>Accessory Uses</b>								
Residential	Home Occupation	P	P	P	P			
	Accessory Structures/ Garage/ Storage	P	P	P	P			

**B. Home Occupations**

1. Purpose

The intent of this Subsection is to allow a [home occupation](#) as an [accessory use](#) to a residence when it is operated and designed in a manner such that it blends into the neighborhood and would not be obvious to the casual passer-by that the [site](#) is other than a residence. The home occupation shall not be carried out in a way that disturbs the lifestyle of other residents in the neighborhood. The home occupation may not be operated in a way that creates an unhealthy, unsafe, or unwholesome environment for the operators, customers, neighbors, or the general public.

2. Criteria for Operation of Home Occupation

Home occupations may be conducted within a [dwelling unit](#) or [accessory building](#) in any district as an [accessory use](#) to a residence only if the following criteria are met:

- a. City and state sales tax licenses must be obtained if sales taxable by the City or state sales taxes are to be made;
- b. Only the residents of the dwelling unit and one employee may be engaged in the home occupation;
- c. The home occupation does not change the essential residential character of dwelling unit or accessory building;
- d. No more than 50% of the total [floor area](#) of the main level floor of the dwelling unit is devoted to the home occupation;
- e. No equipment or materials used in the home occupation may be stored outside the building;
- f. Sales of goods or items to customers on the premises is prohibited, except for items made or created on the premises. Services may be provided on the premises but shall not involve objects which are too large to be carried by an individual;
- g. Except in the R-1 zoning district, signs shall comply with applicable sign regulations; and
- h. In the R-1 district, the following criteria must be followed:
  - i. No mechanical, electrical or other equipment or items that produce noise, light, electrical or magnetic interference, vibration, heat, glare, smoke, dust, odor or other nuisance outside the residential [building](#) or [accessory building](#) or [structure](#) may be [used](#);
  - ii. No more than 8 customers, or in the case of day care or schools, 8 children including children of the [family](#) living in the residence, may be present on the premises at any one time.

**C. Manufactured Home and Recreation Vehicle (RV) Park Standards**

1. Application and Permit

- a. It shall be unlawful to commence the construction of any [manufactured home](#) or [RV park](#), or the enlargement of an existing park until a site development permit has been approved by the City Council as meeting the criteria and requirements of this Subsection and other applicable city and state regulations.
- b. Application for a site development permit shall be made by submitting a [site](#) plan of the proposed park, accompanied by any supporting documents, plans or drawings, as necessary, to show that the requirements of Subsection 7-7-C-2 will be met.
- c. Staff Review. The City staff shall review the application to determine whether it is complete. If the application is not complete, City Staff shall notify the Applicant in writing and shall take no further action on the application until the deficiencies are remedied. If the application is complete, then City staff shall affix the date of acceptance and assign the application an agenda date with the Planning Commission which shall be no less than thirty days from the date of acceptance. The Applicant will submit 14 copies of the original Land Use Application, Site Plan, proof of mailing, and any other supporting documents on 3-hole punched paper to City Staff no later than 15 days prior to the date of the Planning Commission meeting at which the application is scheduled to be considered.
- d. Planning Commission shall recommend approval, approval with conditions or denial of the application to City Council. Planning Commission and City Council shall review the application's consistency with the requirements of Subsection 7-7-C-2 or 7-7-C-3, as applicable.
- e. Following approval of the site development permit, the park shall be developed, and no homes may be placed in the park until the improvements are properly completed and occupancy permit issued.

## 2. Manufactured Home Park Design Requirements

- a. [Manufactured home](#) parks may be located only where allowed by City zoning regulations and shall be a minimum of two (2) acres.
- b. All manufactured home parks shall, as a minimum, comply with the regulations for manufactured home parks issued by the State of Colorado and the requirements of this Subsection (b). In the event of any conflict between the State regulations and the requirements of this Subsection or other ordinances and regulations of the City, those regulations, which are more stringent, shall apply.
- c. Each space may have only one (1) manufactured or [mobile home](#) located on it and shall comply with the dimensional requirements of this subsection. All spaces shall be adequately identified by a number or letter.
- d. Minimum space area shall be 2,500 square feet.
- e. Minimum [setbacks](#) within each space:
  - i. Front setback shall be 12 feet
  - ii. Rear setback shall be 8 feet

iii. Side on Corner Space setback shall be 7.5 feet

iv. Side setback shall be 5 feet

f. Accessory [structures](#) which are not attached to the [manufactured home](#) are not subject to the rear and side [yard](#) setbacks but shall be set back a minimum of two (2) feet.

g. The manufactured home park developer shall provide improvements developed to the standards required in this Subsection of the OLUC and shall provide the following:

i. A park or playground occupying at least 5% of the area of the manufactured home park to be maintained by the manufactured home park owner.

ii. Refuse collection for each manufactured home space shall be provided.

3. Recreational Vehicle (RV) Home Park Design Requirements

a. Size and location. [RV Parks](#) may be located only where allowed by City zoning regulations and shall be a minimum of two (2) acres in area.

b. All RV parks shall, at a minimum, comply with applicable State of Colorado Regulations for campgrounds and recreation areas and the requirements of this subsection. In the event of any conflict between state regulations and the requirements of this subsection or other city ordinances or regulations, those regulations which are more stringent shall apply.

c. Dimensional Requirements:

i. All RVs and any accessory structures shall be at least ten (10) feet from any other RV and accessory structure.

ii. The number of RVs in the park shall not exceed 25 [RVs](#) per acre.

d. Five percent (5%) of the gross area of the RV park shall be developed and maintained as a park or playground by the park owner.

e. The RV park developer shall provide the following improvements:

i. A water system, including fire hydrants and fire mains.

ii. A sanitary sewer system.

iii. [Streets](#) with a minimum width as follows:

1. One-way/no parking – 11 feet;

2. One-way/parking on one side – 18 feet;

3. Two-way/no parking – 24 feet;

4. Two-way/parking on one side – 27 feet;

5. Two-way/parking on both sides – 34 feet.

iv. A storm drainage system.

- v. [Street](#) signs to include traffic circulation and security lights.
- vi. A service [building](#) meeting the requirements of applicable state and City regulations.
- vii. The City may require reasonable utility easements to be dedicated to the public for the purpose of public and City utilities.
- viii. Designs for dump stations, when provided, shall be approved by the City.

4. Maintenance of Manufactured Home and Recreational Vehicle (RV) Parks

- a. All [manufactured home](#) and [RV parks](#) shall be maintained in accordance with the requirements of this Section, applicable State of Colorado Department of Health Regulations, and other applicable regulations of the City or state.
- b. The City Building Official, or his designated representative, shall have the right to enter upon any manufactured home or RV park at any reasonable time for the purpose of inspecting the premises to determine compliance with this Section or other applicable ordinances and City and State regulations.

**D. Telecommunications Antenna and Tower Standards**

- 1. Telecommunication towers and antennas shall be located, and comply with the following provisions:
  - a. Noncommercial television and telecommunications receivers, and amateur radio antennas which qualify as an [accessory use](#) to the main use on the premises, may be located on such premises.
  - b. Antennas for "personal wireless services" as defined in 47 USC 332(c)(7)(c)(i) shall be limited to the C-1 and C-2 Zoning Districts, or upon City-owned property in other zoning districts pursuant to leases or permits with the City, with terms and conditions adequate to insure safety and reasonable compatibility with the neighborhood in which they are located, including requirements for camouflaging where appropriate.
  - c. Commercial radio, television and other telecommunications transmitters and receivers shall be restricted to commercial zoning districts.
  - d. Additional receivers or transmitters may be installed on existing telecommunication towers regardless of the zoning district.
- 2. All telecommunication antennas and towers shall be limited to the maximum height set out in [Table 7-8-A](#), with the following exceptions:
  - a. Telecommunication antennas, receivers and transmitters may be located on existing towers and [structures](#), or on an extension of an existing tower or structure of no more than 20 feet.
  - b. A [variance](#) to the height limitations otherwise applicable may be obtained for an amateur radio antenna for noncommercial use pursuant to the review procedures of Section 7-5-D-4, if the Planning Commission determines that the following criteria are met:

- i. A higher tower is necessary to be reasonably adequate for the domestic communications purposes;
  - ii. No reasonable alternative exists; and
  - iii. No adverse impacts will be created with respect to other property in the area.
- c. A variance to the height limitations otherwise applicable may be obtained for personal wireless service antennas if the Planning Commission determines pursuant to the review procedure of Section 7-5-D-4 that the following criteria are met:
- i. Space is not available at a commercially reasonable price on an existing tower or structure located in a technically feasible location, and no other location is available which will provide reasonably adequate service in compliance with the height limitations set out above;
  - ii. No adverse effect on property values in the area will be caused and no safety hazard will be created; and
  - iii. The design and color of the tower and appurtenances shall be reasonably compatible with the site and surrounding area.
- d. A final decision to deny a variance shall be in writing and supported by a substantial written record.
- e. All towers and structures shall be subject to the building [setback](#) requirements of [Table 7-8-A](#), and applicable provisions of City building code and other ordinances and regulations.

**E. Recreational Vehicle Parking**

1. In the R-1, R-2, C-1, and C-2 districts, [RVs](#) may be parked as follows:
  - a. Occupied as temporary [dwellings](#) only within a licensed [RV Park](#) in a designated space or with a permit issued by the [City](#).
  - b. RVs less than twenty (20) feet long may be parked, if unoccupied, in compliance with any of the following:
    - i. Upon the public rights of way or other designated public parking area, if registered under state law and lawfully parked in compliance with Section 14-8; provided, however, they may not be parked to create a traffic hazard. An [RV](#) parked pursuant to this subsection may only be parked for a period less than 72 hours. The facts that the position of such an RV is moved along any person's premises, the RV is moved for the primary purpose of avoiding the 72-hour limitation, or the vehicle is moved away for any period of fewer than twenty-four (24) hours, shall be ignored in determining whether or not a vehicle has remained parked in front of any premises for 72 hours. Provided, however, this shall not apply to a vehicle owned or leased by the owner or occupant of the abutting property.
    - ii. Upon a lawful RV sales lot.
    - iii. In a licensed [RV Park](#).

- iv. In a garage.
  - v. As a temporary construction office at the construction site pursuant to a permit issued by the City. Such use shall not include sleeping or cooking.
- c. One RV may be parked either:
- i. On a lot as an [accessory use](#) to a principal [building](#), in the [open space](#) extending the full width of the [lot](#), the depth of which is the horizontal distance between the [rear lot line](#) and the principal building, and in compliance with building setback regulations as illustrated below;

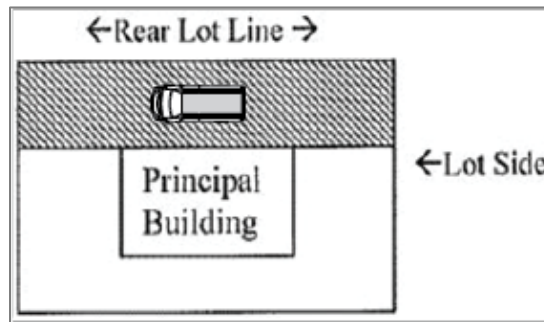

- ii. On a lot as an [accessory use](#) to a principal [building](#), in the [open space](#) between the principal building and the [lot side](#), the width of which is the horizontal distance from the lot side to the principal building, and in compliance with building setback regulations as illustrated below; or

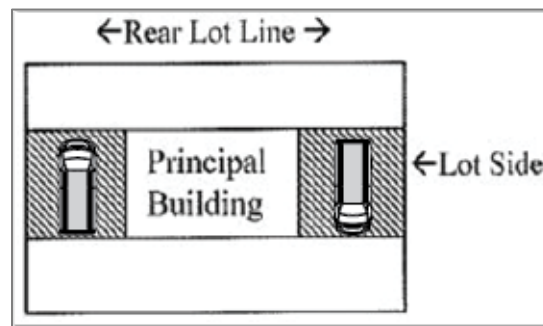

- iii. On a vacant [lot](#), in the [open space](#) between the principal [building](#) and the farthest [lot side](#) of the vacant lot and extending to the [rear lot line](#) of the vacant lot, as long as the following criteria are also met:

1. The lot with the principal building, the vacant lot, and the RV are owned by the same owner.
2. The vacant lot is contiguous to the lot on which the principal building is located.

3. Parked in compliance with building [setback](#) regulations as illustrated:

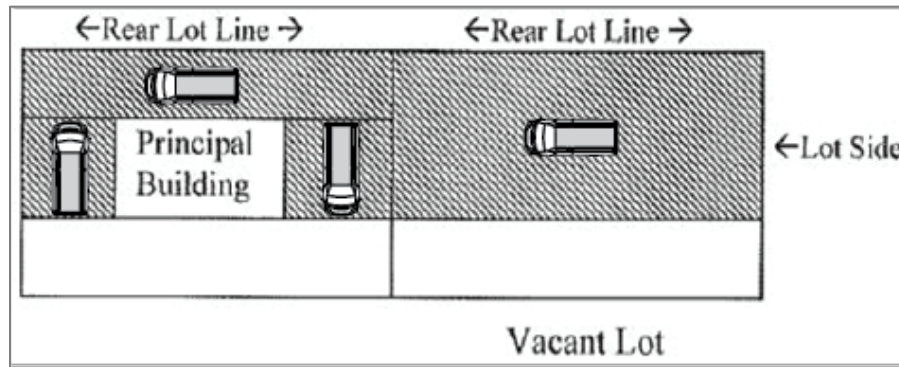

- d. In the parking [lot](#) of a [lodging business](#), the owner of a lodging business may park one (1) RV and a guest of the lodging business may park one (1) RV during their stay.
2. RVs twenty (20) feet or longer may be parked, if unoccupied, in compliance with any of the following:
- a. Upon the public right of way or other designated public parking area, if registered under state law and lawfully parked in compliance with Section 14-8; provided, however, they may not be parked to create a traffic hazard. An RV parked pursuant to this subsection may only be parked for a period less than 72 hours. The facts that the position of such an RV is moved along any person's premises, the RV is moved for the primary purpose of avoiding the 72-hour limitation, or the vehicle is moved away for any period of fewer than twenty-four (24) hours, shall be ignored in determining whether or not a vehicle has remained parked in front of any premises for 72 hours.
  - b. Upon a lawful RV sales lot.
  - c. In a licensed RV Park.
  - d. In a garage.
  - e. As a temporary construction office at the construction site pursuant to a permit issued by the City. Such use shall not include sleeping or cooking.
  - f. For temporary habitation when used in conjunction with construction.
    - i. An RV may be used for temporary living quarters for not more than eighteen (18) months while the occupant thereof is repairing or constructing a permanent dwelling on the same property. Before an RV will be permitted in such an instance, the owner of the property or the person intended to occupy the RV shall secure a [conditional use](#) permit for the [RV](#) from the Planning Commission. Such permit shall be granted upon the receipt of a signed statement by the [applicant](#) that a permanent [dwelling](#) will be constructed within twelve (12) months thereafter. Construction must start within sixty (60) days of RV placement. Only one (1) RV shall be permitted on any [parcel](#) of [land](#) during the construction or repair of a permanent dwelling. A repair shall be considered when the repair will cause a condition that disallows the homeowner from occupying the inside of the home during the repair

construction. Repairs that are minor and can be confined within the interior shall not be considered.

**F. Accessory Dwelling Units (ADUs)**

1. [Dwelling units](#) which meet the criteria of this Subsection may be allowed as an [accessory use](#) to a principal residential unit in the R-1, R-2, C-1 and C-2 districts provided that the dwelling units conform to the applicable requirements of said Districts.
2. The [accessory dwelling](#) unit must be constructed in accordance with applicable requirements of Code adopted by the City pursuant to Chapter 6 of Ouray Municipal Code. It may be attached or detached to the principal residential unit. Applicable dimensional requirements for a [single-family dwelling](#) as set out in [Table 7-8-A](#) must be met for the premises.
3. One off-street [parking space](#) shall be provided for the accessory unit in addition to any other required off-street parking.
4. The accessory dwelling unit may not exceed 1,000 square feet of living area.
5. If any of the dwelling units are rented, a minimum of a 90-day rental period shall be required by written lease.
6. The accessory dwelling unit must be owned together with the principal residential unit in undivided ownership.
7. The accessory dwelling unit may be served off of the water and sewer taps for the principal residence, in which case it shall not be subject to additional investment fees, and the primary residence and accessory dwelling unit shall be charged as a [duplex](#) for water and sewer service rates.
8. The burden shall be upon the owner of any accessory dwelling unit to provide adequate proof to the City that the criteria of this Section are met. In the event that the City determines that the criteria have not been shown to be satisfied the unit may not be occupied as a residence.
9. A dwelling unit constructed as a principal single-family home, which meets these criteria, may be converted to an accessory dwelling unit following construction of a new principal dwelling unit.

**G. Medical/Retail Marijuana**

1. Medical Marijuana Centers, Medical Marijuana-Infused Products Manufacturers, Retail sales, Grows and Optional Cultivation Premises Operations are prohibited uses in all zoning districts within the City of Ouray.

**H. Short Term Rentals**

1. Purpose

To prevent adverse impacts attributable to [short-term rentals](#) in [dwelling units](#); preserve the current character and ambience of City neighborhoods; protect public health, safety, and welfare; and ensure compatibility with surrounding land [uses](#).

2. Applicability

These regulations apply to any owner of real property with [dwelling unit](#) (dwelling units) used as an STR, whether directly or indirectly, in R-2, C-1, and C-2 Zone Districts, for less than thirty (30) consecutive days.

### 3. Prohibitions and Conditions

- a. STRs are prohibited in the R-1 Zone District.
- b. STRs are prohibited in accessory dwelling units.
- c. A maximum number of STR licenses, also known as a Cap, may be adopted by City Council from time to time.
- d. Dwelling units with an STR license must use the dwelling unit as a STR for thirty (30) or more days each annual license period.

### 4. Exemptions

- a. Any STR within the R-1 Zone District in existence and use as an STR prior to July 17, 2019, must obtain an STR license and upon the granting of a license such use shall be deemed as legal non-conforming. Upon non-renewal, or transfer in ownership of the real property of any kind, such license and use shall cease.
- b. Dwelling units located within a [lodging business](#) premises are exempt but those located outside the lodging business premises must have an STR license if the property is assessed with a residential tax rate.
- c. STR Cap and Trade. Any real property owner who provides three (3) new dwelling units for rent for more than 30 consecutive days on the same parcel, after adoption of this Ordinance, may obtain one (1) STR license for a fourth dwelling unit on the same parcel and shall be considered exempt from any STR license cap, so long as the policies concerning this exemption are met, as determined by City Council from time to time. When using the STR Cap and Trade program, a real property owner may use one (1) of the three (3) dwelling units as their primary residence and be excluded from the cap. The real property owner shall execute an affidavit when the STR license is issued stating that three (3) dwelling units are being utilized as rentals with a minimum lease agreement of six (6) months, excluding, if applicable, the real property owner's primary residence and shall provide the City, upon request, proof of lease agreements. All other requirements of these regulations apply, including policies and procedures, adopted by City Council from time to time.

### 5. Registration, Licensing, and Renewals

- a. An application is required to be submitted in accordance with the STR administrative policies and fee schedules, as City Council may adopt from time to time.
- b. The City Administrator, or any authorized staff, may issue and regulate short-term rental licenses, administratively.
- c. Upon submittal of a new STR application, a site inspection will be conducted to ensure the dwelling unit meets the City's adopted building codes.

- d. License renewals may require an additional inspection if substantial changes to the premises were made or complaints arose during the previous licensing period, as determined administratively.
- e. An STR license is issued to the real property owner and is not transferable, except if the real property for which a valid STR license has been issued is transferred pursuant to a deed meeting any of the following conditions (these exceptions do not apply to any STRs within R-1):
  - i. The transfer of title to real property if the grantee is a member of the grantor’s [family](#).
  - ii. The transfer of title to real property from a grantor to a trust established by the grantor.
  - iii. The transfer of title to real property from a grantor to a limited liability company or another form of business entity recognized by Colorado law so long as the grantor has a controlling interest in such limited liability company or other business entity.
  - iv. Any transfer of the property between the same parties creating or terminating a joint tenancy in such property.
  - v. The transfer of title or change of interest in real property by reason of death, pursuant to a will, the law of descent and distribution, or otherwise.
  - vi. The transfer of title to make effective any plan confirmed or ordered by a court of competent jurisdiction under the bankruptcy code or in an equity receivership proceeding.
  - vii. The transfer of title without consideration for the purpose of confirming, correcting, modifying, or supplementing a transfer previously recorded; making minor boundary adjustments; removing clouds of titles; or granting rights of way, easements, or licenses.
  - viii. The transfer of title pursuant to any decree or order of a court of record quieting, determining, or vesting title, including a final order awarding title pursuant to a condemnation proceeding.
  - ix. The transfer of title between spouses or former spouses made pursuant to a separation agreement, decree of legal separation, or dissolution of marriage.
- f. The real property owner remains solely responsible for compliance with these regulations and any policies adopted by City Council from time to time.
- g. Licenses are valid for one (1) year; and all license renewals shall be due on or before February 28 of each year.
- h. Real property owners who have an STR license must maintain liability insurance during the licensing period, as set forth in the administrative policies adopted by City Council from time to time.

## 6. Signs and Advertising Standards

- a. External signs are prohibited for short-term rentals in the R-2 zone district and within the R-1 zone district on any non-conforming STRs.

- b. One (1) internal sign no larger than 8 1/2" x 11" is allowed in R-1 and R-2 to identify a particular dwelling unit.
- c. Signs in the C-1 and C-2 zone districts shall comply with the City Sign Code.
- d. All short-term rentals shall clearly post the correct address on the exterior of the building in accordance with City addressing and street numbering requirements.

#### 7. Rules

- a. The maximum number of [persons](#) per short-term rental shall be two (2) per bedroom, plus two (2) additional persons.
- b. Noise Ordinance shall be followed.
- c. The real property owner is responsible to remit all applicable local, state, and federal taxes, along with applicable Lodging Occupation Tax, Sales Tax, or any other applicable local tax, unless exempt.
- d. Real property owner shall designate a responsible party who is located within a forty-five (45) minute drive of the City and available for immediate response to issues or emergencies that arise from the short-term rental.

#### 8. Parking Standards

- a. Parking shall meet any applicable provisions of the Ouray Municipal Code and any specific parking requirements of the underlying zone district.

#### 9. Snow Removal

- a. Real property owner shall comply with all City requirements for snow removal on public sidewalks, in addition to the requirement to remove snow from STR [parking spaces](#), walkways, and the entrance to the short-term rental.

#### 10. Building Code Requirements

- a. An STR shall only be used for one party that occupies the entire dwelling unit. Individual rooms within a single-family dwelling short-term rental shall not be rented out unless (a) the [dwelling unit](#) is separate, attached, or detached and it complies with the City of Ouray Municipal Code requirements; or (b) the short-term rental has a separate entrance from the primary dwelling, the bedroom areas have been constructed in accordance with the City's adopted building codes, no more than one [short-term rental](#) bedroom is provided on the property, and the [building use](#) and design complies with the underlying zone district requirements.
- b. The short-term rental shall meet all applicable local, state, and federal regulations, including the requirement for carbon monoxide detectors under C.R.S. § 38-45-101 et seq.; lighting; one (1) wall mounted, certified, five (5) lb. ABC Fire Extinguisher within the short-term rental [kitchen](#) area; smoke detector requirements; and, all other life-safety requirements, such as egress from sleeping areas.

#### 11. Refuse

- a. The real property owner is responsible for proper disposal of garbage, refuse and trash collection in accordance with the Ouray Municipal Code.
- b. STRs will be charged the residential rate for trash removal unless there are two or more trash violations within a six (6) month period and then the real property owner may be required to provide for two residential trash services at the same address to manage trash (paying for two cans at the residence), or to provide for a commercial trash pickup of trash if two residential service pickups do not resolve the trash complaints.
- c. All trash shall be properly stored within containers that are not visible from any public [street](#) or sidewalk.

#### 12. Other General Requirements

- a. Short-term rentals must replace any exterior open light fixtures with dark sky compliant lighting.
- b. Real property owner must abide by all other applicable local, state, and federal laws and regulations.

#### 13. License Posting Requirements

- a. The STR License must be posted in a conspicuous place and contain the following items:
  - i. Contact information for the owner or responsible party.
  - ii. The STR address and license number.
  - iii. Maximum number of guests.
  - iv. Location of fire extinguishers.
  - v. A copy of the noise ordinance.
  - vi. Parking and snow storage rules.
  - vii. Trash disposal information.
  - viii. How to sign up for emergency notifications.
  - ix. Information on any City fire bans, or water use restrictions.
  - xi. Map showing locations where trailer and large vehicle parking is allowed.

#### 14. Revocation or Suspension of License

- a. A license may be revoked after notice to the real property owner and opportunity to be heard for violations which result in more than two suspensions or serious violations which affect the health, safety, and welfare of the public.
- b. An STR license in the R-1 Zone District is a legal non-conforming use and upon the nonrenewal, suspension, revocation, abandonment of use or any transfer of ownership interest

in the real property containing the [dwelling unit](#) with the STR license, the STR license is revoked immediately. There are no exceptions, and no affirmative or other defenses of any kind.

c. A license may be suspended after notice to the real property owner for:

i. One or more violations of any condition of the license or of any provision of these regulations during the licensing period.

ii. Written notice of any violation shall be mailed to real property owner at the address provided in the most recent application.

iii. The suspension is effective seven (7) days after the date of the notice.

iv. This suspension procedure does not apply when an emergency arises which affects the health, safety, and welfare of the public under the City's police powers.

#### 15. Violations and Penalties

a. It shall be unlawful to operate a short-term rental without a valid license or to violate any provision in these short-term rental regulations or any other City ordinance, resolution or official policy regarding short-term rentals or any state law or federal law.

b. Violations are declared to be a nuisance, which may be abated in any lawful manner, including Section 10-4 of the Ouray Municipal Code (OMC).

c. Enforcement and penalties for violations of these Short-term Rental regulations shall be as provided for in OMC, Section 7-2.

#### 16. Appeals

a. Appeals of administrative decisions under these regulations shall be pursuant to OMC Section 7-5-C-7, except an appeal will be heard by City Council and not the Planning Commission.

#### I. **Outdoor Displays of Merchandise**

1. Outdoor displays of merchandise on private property are subject to the following:

a. Merchandise shall not be stacked or stored, but displayed for sale;

b. The area used for outdoor display does not exceed the aggregate area of the footprint of the interior retail area;

c. The merchandise shall not cover more than 30% of an area used for parking;

d. Additional outdoor display area may be permitted with approval of a [conditional use](#) permit

#### J. **Intermodal Shipping Containers**

1. [Intermodal shipping containers](#) are allowed for temporary construction storage in all zoning districts in association with permitted construction provided:

a. The maximum length of time is one (1) year from the date of building permit issuance;

b. A refundable cash financial guarantee in the amount of \$750.00 per container is provided to the City to cover the cost of removal. A written extension of the initial period not to exceed one-hundred-eighty (180) days may be granted by the Building Official;

- c. Shipping containers will not be stacked; and
- d. The shipping container is located on private property to the extent practicable, or the City has issued an encroachment permit for it in a right-of-way adjoining the construction [site](#).

**K. Affordable, Attainable, and Workforce Housing**

1. The City of Ouray is committed to providing an inclusive, vibrant community where all incomes can live and work. To help achieve this goal, the following density bonuses are available to projects that include, at a minimum, 20% of the units restricted to units that meet the definition of Affordable, Attainable or Workforce housing in this code. The following bonuses shall apply:

- a. [Affordable](#): Up to 80% density bonus
- b. [Attainable](#): Up to 50% density bonus
- c. [Workforce](#): Up to 25% density bonus

2. Affordable/Attainable/Workforce housing units will be exempt from maximum floor area requirements but will generally be required to meet all other dimensional requirements. The Planning Commission can grant exceptions to dimensional requirements only after due consideration to neighborhood compatibility, safety and character.

Table 7-7-K: Affordable, Attainable, Workforce Density Bonuses				
		Zoning District		
		R-2 (S of Skyrocket)	R-2 (N of Skyrocket)	C-2 (N & S of Skyrocket)
<b>Density By Right</b>	Min. Lot Area	7,100 SF	7,100 SF	7,100 SF
	Max Density	2,370 SF / D.U.	3,550 SF / D.U.	3,550 SF / D.U.
	Allowable Dwelling Units	<b>3 D.U.</b>	<b>2 D.U.</b>	<b>2 D.U.</b>
<b>Density Bonus</b>	<b>Affordable Housing (80%)</b>	<b>(3 x 1.8) = 5.4 D.U.</b>	<b>(2 x 1.8) = 3.6 D.U.</b>	<b>(2 x 1.8) = 3.6 D.U.</b>
	<b>Attainable Housing (50%)</b>	<b>(3 x 1.5) = 4.5 D.U.</b>	<b>(2 x 1.5) = 3 D.U.</b>	<b>(2 x 1.5) = 3 D.U.</b>
	<b>Workforce Housing (25%)</b>	<b>(3 x 1.25) = 3.75 D.U.</b>	<b>(2 x 1.25) = 2.5 D.U.</b>	<b>(2 x 1.25) = 2.5 D.U.</b>

## Section 7-8 Dimensional Requirements and Development Standards

### A. Table of Dimensional Standards

1. All primary and accessory structures are subject to the dimensional standards set forth in [Table 7-8-A](#). These general standards may be further limited or modified by other applicable sections of this Land Use Code. General rules for measurement and exceptions are in Section 7-8-C.

Table 7-8-A: Table of Dimensional Standards								
	P-1	P-2	R-1	R-2 South of Skyrocket	R-2 North of Skyrocket	C-1	C-2 South of Skyrocket	C-2 North of Skyrocket
<b>Minimum Lot Area</b>	NA	NA	7,100 s.f.	7,100 s.f.	7,100 s.f.	3,500 s.f.	7,100 s.f.	7,100 s.f. for any use
<b>Maximum Density</b>	NA	NA	3,500 s.f./ D.U.	2,370 s.f./ D.U.	3,550 s.f./ D.U.	NA	3,550 s.f./ D.U.	3,550 s.f./ D.U.
				790 s.f./ L.U.	1,183 s.f./ L.U.		1,183 s.f./L.U.	1,183 s.f./ L.U.
<b>Minimum Front Setback</b>	As determined by Planning Commission based on natural terrain, parcel boundaries, roads, building color, ridge lines and preservation of the area.	As determined by Planning Commission based upon the natural terrain, roads, building color, ridge lines and preservation of the area.	15 feet, subject to lot averaging.	15 feet, subject to lot averaging.	15 feet, subject to lot averaging.	For lots on or within the Ouray Commercial Historic District or for lots on U.S. Highway 550, between 3rd Avenue and the southern edge of the Cascade Flume, alley-to-alley: No minimum setback.	15 feet, subject to lot averaging.	15 feet, subject to lot averaging.
			All other blocks: 15 ft.	All other blocks: 15 ft.	All other blocks: 15 ft.	For lots on U.S. Highway 550, between the northern edge of the Cascade Flume and south boundary of Sampler Mill site: 10 feet, subject to lot averaging.		

Ouray Municipal Code  
Chapter 7 – Land Use and Development Code

<b>Minimum Side Setback</b>	Same determination as front setback.	Same determination as front setback.	5 ft.	5 ft.	5 ft.	5 ft., except: No minimum setback for lots on or within the Ouray Commercial Historic District	5 ft.	5 ft.
<b>Minimum Rear Setback</b>	Same determination as front setback.	Same determination as front setback.	5 ft.	5 ft.	5 ft.	5 ft.	5 ft.	5 ft.
<b>Maximum Floor Area</b>	NA	NA	Ouray Local and National Historic District: 10% greater than the average of other structures on the block front or 4,260 sq. ft., whichever is less	Ouray Local and National Historic District: 10% greater than the average of the primary structures on the block front or 4,260 sq. ft., whichever is less	10,650 s.f.	Ouray Commercial Historic District and Fronting Highway 550: 9,585 s.f. per 25 feet of frontage on Highway 550 of the lot on which the building is located.	15,000 s.f.	15,000 s.f.
			All other properties: 4,260 sq. ft.	All other properties: 10,650 sq. ft.		All other properties: 9,585 sq. ft.		
<b>Maximum Site Coverage</b>	5%	5%	30%	50%	40%	90%	50%	40% for residential use
								50% for mixed use
								60% for commercial use
<b>Maximum Building Impervious Surface Site Coverage</b>	NA	NA	80%	80%	80%	100%	80%	80% for any use
<b>Maximum Height</b>	20 ft.	10 ft.	30 ft.	35 ft.	35 ft.	35 ft.	35 ft.	35 ft.
<b>Maximum Size for Accessory Buildings</b>	NA	NA	Accessory Use to Single Family Dwelling: 600 sq. ft.	Accessory Use to Single Family Dwelling: 600 sq. ft.	Accessory Use to Single Family Dwelling: 600 sq. ft.	NA	Accessory Use to Duplex: 600 sq. ft.	Accessory Use to Duplex: 600 sq. ft.
							Accessory Use to Multi-Family Dwelling: 800 sq. ft.	Accessory Use to Multi-Family Dwelling: 800 sq. ft.

**B. Maximum Density/Minimum Lot Area**

1. Maximum [density](#) is the maximum number of [dwelling units](#) allowed (D.U.) or lodging units (L.U.) per sq. ft. of gross [lot area](#) listed. The density is determined by dividing the number of units on a site by the gross acreage of the [site](#), including any [land](#) area required to be dedicated for right-of-way. In the determination of the number of units to be allowed on a specific [parcel](#) of land, a fractional unit equal to or greater than one-half of a unit shall be rounded up to equal a full unit; a fractional unit less than one-half of a unit shall be rounded down.

**C. Setbacks**

1. Except as provided in this Land Use Code, every required front, side, and rear [setback](#) space shall be open and unobstructed from the ground to the sky.

2. Setbacks on Corner Lots:

a. A corner lot abutting upon two (2) streets in a residential zone shall have the front setback determined by where the home fronts. The remaining [street frontage](#) will be a side setback.

3. Setbacks Measured from Property Lines

a. Verification of boundaries is the responsibility of the owner. In all zones, which require front, side, and/or rear [yards](#), the required depth of said yards shall be measured from the property line along a line perpendicular to the [property line](#).

4. Irregularly Shaped Lots

a. In the case of lots having more than four (4) lot lines or [lots](#) which vary considerably from a rectilinear or trapezoidal shape, the [rear lot line](#) shall be considered as the line most nearly opposite from and parallel with the [street](#) line on which the lot abuts as illustrated below.

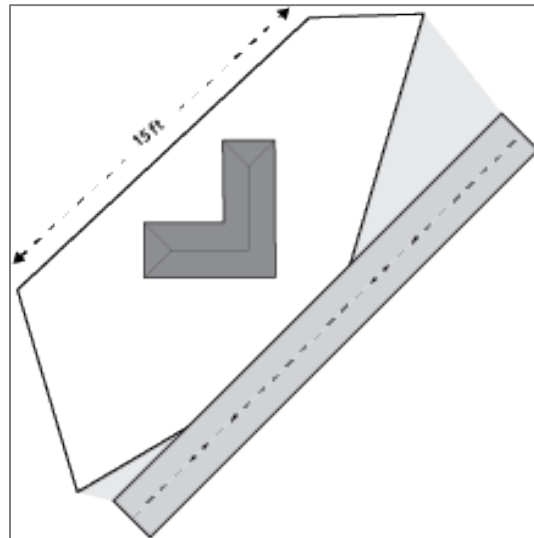

b. In the case of a triangular shaped lot, the [rear lot line](#) shall be considered as a straight line fifteen feet (15) in length which:

i. Is parallel to the [front lot line](#) or its chord; and

- ii. Intersect the two (2) side lot lines at points most distant from the front lot line as illustrated below.

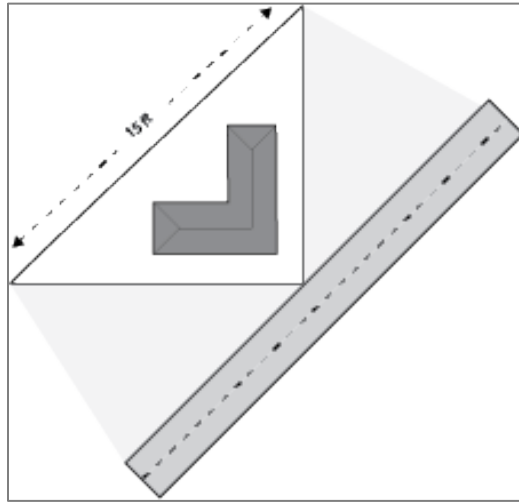

5. Building Setback Calculation

- a. Front Setback. The minimum front setback shall be equal to the average of the existing building front setbacks on the block front, or the district setback, whichever is less. In calculating the average of the existing building front setbacks, staff shall exclude buildings in which the setback distance was determined erroneously, and staff may exclude [buildings](#) if they determine inconsistencies exist.
- b. Side setback shall be measured as illustrated below.
- c. Rear setback shall be measured as illustrated below.

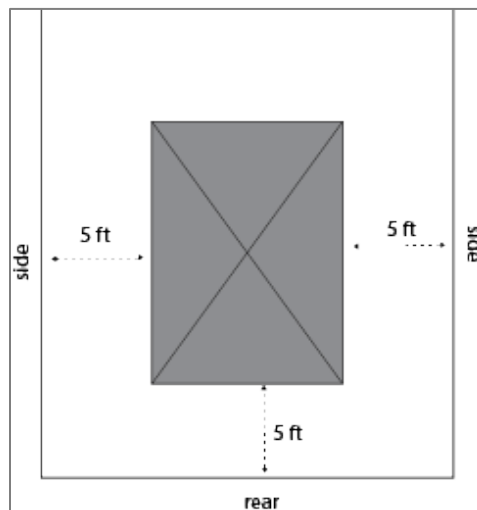

6. Exceptions

- a. [Structures](#) permitted to intrude into required [yard setback](#) area. The following structures may intrude into any required yard which is five (5) feet or greater in width or depth, provided however, that no such structure shall intrude into the required yard a distance greater than is permitted in this Section:

- i. Cornices, eaves, vigas, sills, buttresses, or other similar architectural features – one foot.
- ii. Fireplace structures not wider than eight (8) feet measured in the general direction of the wall of which it is part – one foot.
- iii. Open stairways, balconies, and fire escapes -- one foot.
- iv. Permanent planters not exceeding forty-two inches in height – one foot.
- v. Portable sheds or small storage units 120 sq. ft. or less in size and not on a permanent foundation are allowed to encroach on rear and side setbacks. They may not be located in the front setback or create snow shed, drainage or other issues for neighbors.
- vi. Little free libraries, other similar free boxes, and temporary uses such as lemonade stands are permitted in the front setback area as long as they do not obstruct the public right of way.

**D. Building Height**

1. No [building](#) shall be erected or altered that will exceed the height limit for the respective zoning district, unless otherwise provided for below or elsewhere in this Land Use Code.

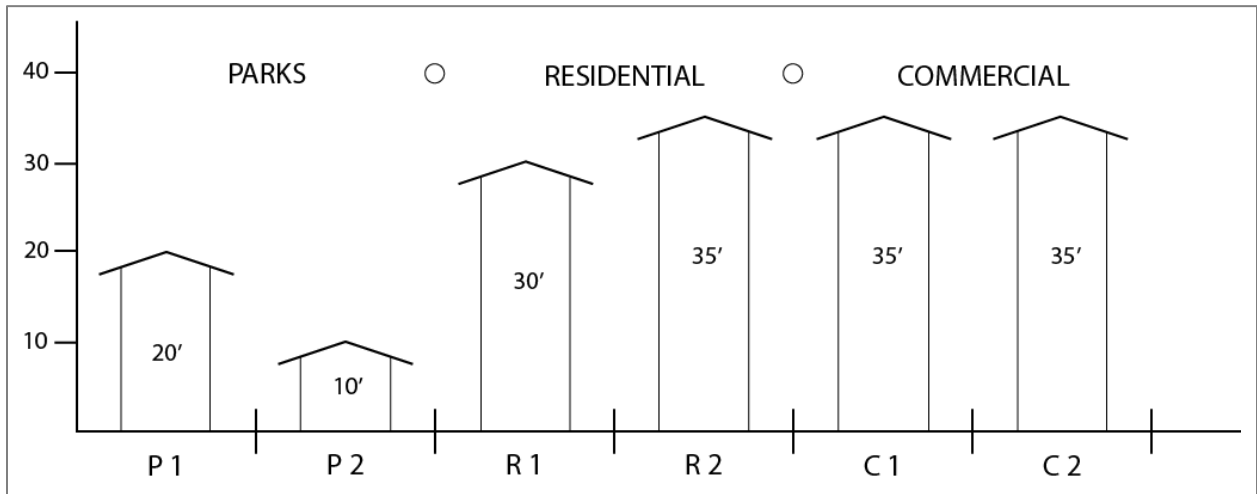

2. The following building elements and appurtenances may exceed the height limits but only to the minimum degree necessary to achieve compliance with applicable building codes, or if not regulated by building codes, to provide for appropriate function:

- a. Chimneys, vents, attic fans, cupola vents, plumbing vents, solar panels, and light collection domes for daylighting systems.

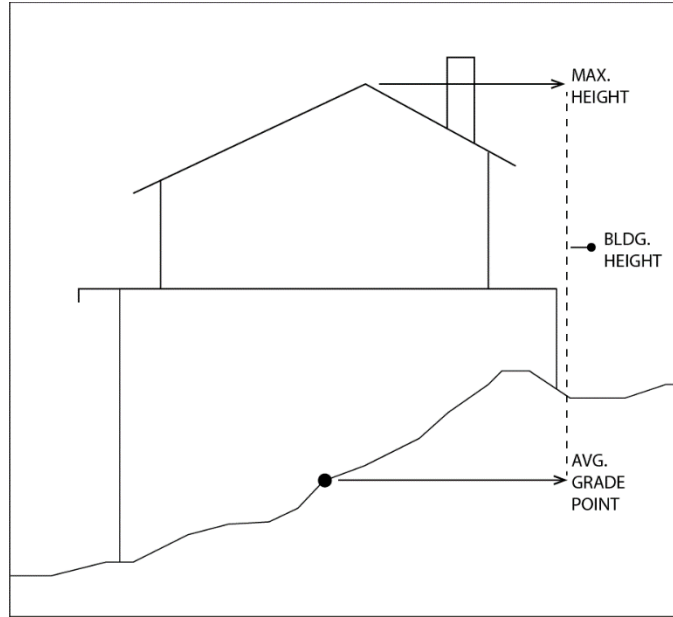

**E. Parking**

<b>Table 7-8-E: Off-Street Parking Requirements</b>	
<b>Use</b>	<b>Number of Parking Spaces Required</b>
Dwelling Unit: Single-Family	2 per Dwelling Unit
Dwelling Unit: Multi-Family	1 bedroom/studio: 1 per dwelling unit 2 bedrooms and up: 1.5 per dwelling unit
Lodging Unit	1 per lodging unit
Schools	1 per classroom
Churches	1 per 8 seats
Retail, Service Businesses	2 s.f. per each s.f. of floor area
Accessory Dwelling Units	1 additional space
Manufacturing, Warehousing	1 space per employee

1. Off [street](#) parking shall be provided for all new uses in compliance with [Table 7-8-E](#), this section and all other applicable sections of this land use code and adopted infrastructure standards. Uses not specifically identified in [Table 7-7-A](#) shall be classified within the use group which most nearly resembles the actual use or determined based on a specific study by a qualified transportation planner or traffic engineer. The following standards and exceptions apply:

a. One of the required off-street [parking spaces](#) may be satisfied by utilizing that portion of the public right-of-way adjacent to the subject property not utilized for roadway or pedestrian purposes.

b. No off-street parking is required for buildings that front U.S. Highway 550 between 4th and 9th Avenues, and those lots that front 4th through 9th Avenues within one-half [block](#) of U.S. Highway

550, except [Lodging Businesses](#) and residences that must provide one space for each lodging or dwelling unit.

c. If necessary to preserve historic buildings, off-street parking requirements may be considered by the Planning Commission. Dedicated on-street parking may be authorized by City Council within the C-1 District, pursuant to Subsection 13-1 of the Ouray Code, for Lodging Businesses in historic buildings, which are listed in the National Register of Historic Places or as a contributing structure to the Ouray Historic District and located on lots that front U.S. Highway 550 or on the intersecting Avenues within one-half block of U.S. Highway 550. Planning Commission shall make a recommendation to City Council regarding an application to waive off-street parking requirements or dedicate on-street parking.

d. As a condition of either waiving off-street parking requirements, or of providing designated on-street parking, the property owner must properly execute, on forms approved by the City, a recordable covenant providing that any repairs or modifications to the building will comply with the United States Secretary of the Interior’s Standard for Historic Preservation Projects and detailing any required maintenance of the parking spaces.

e. Accessible parking shall be provided in compliance with the Americans with Disabilities Act.

f. When six or more spaces are required, the required parking and maneuvering areas shall be paved.

g. Workforce, attainable, or affordable projects may be considered for reductions in these requirements or may be allowed to provide parking off site, as determined by the Planning Commission after full consideration of neighborhood impacts informed by a parking study.

2. Parking shall be designed and intended to be occupied by a parked automobile. Each space shall contain 200 sq. ft. in area and measuring 20' by 10', exclusive of maneuvering and roadway space as seen in illustration below.

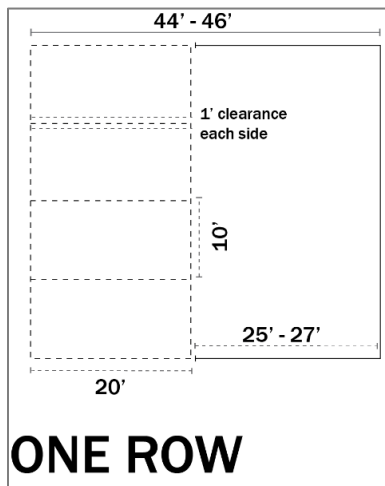

3. Standards for vehicular maneuvering are contained in the City’s Specifications and Design Standards for Infrastructure Construction.

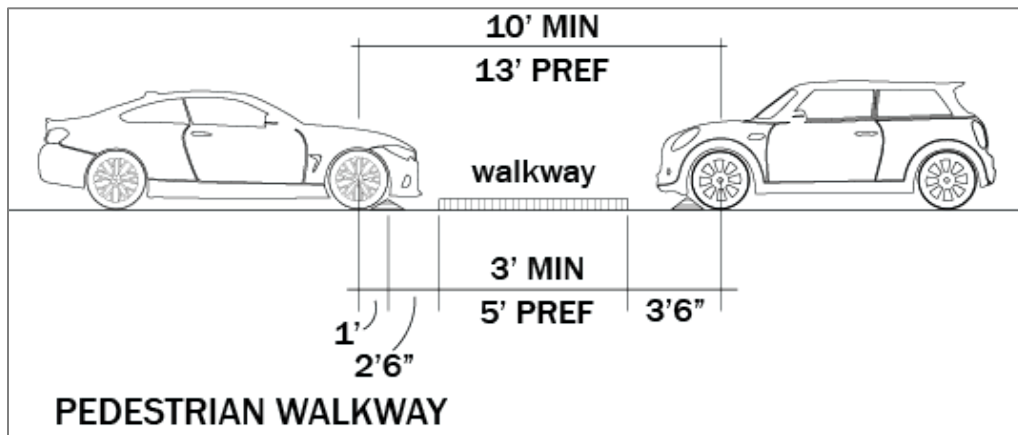
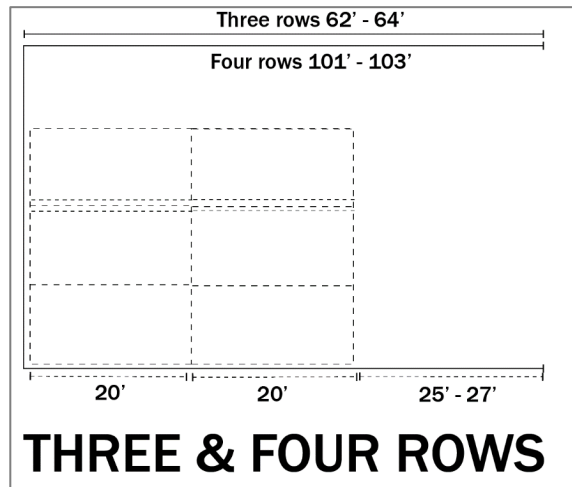
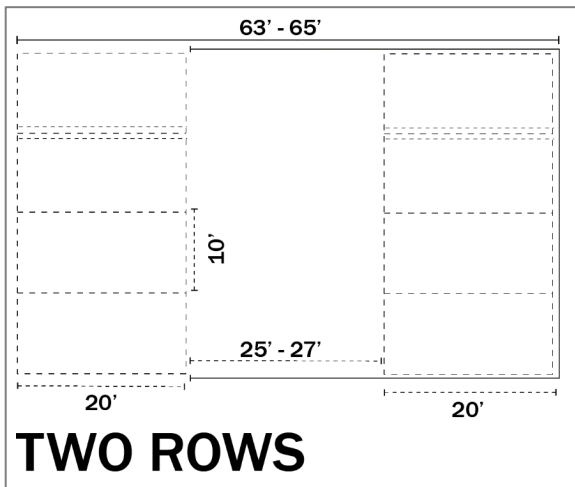
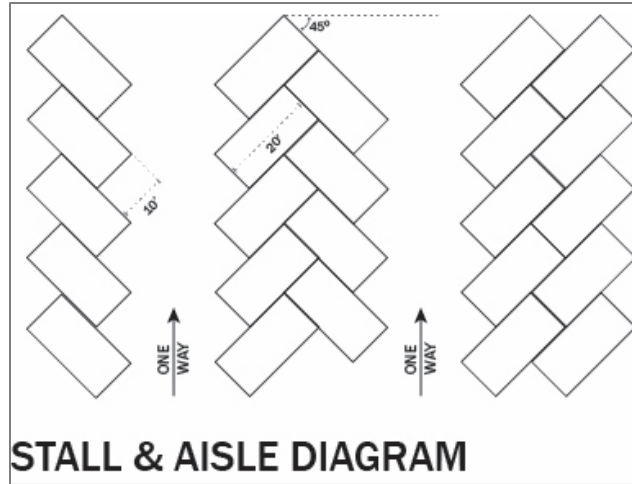

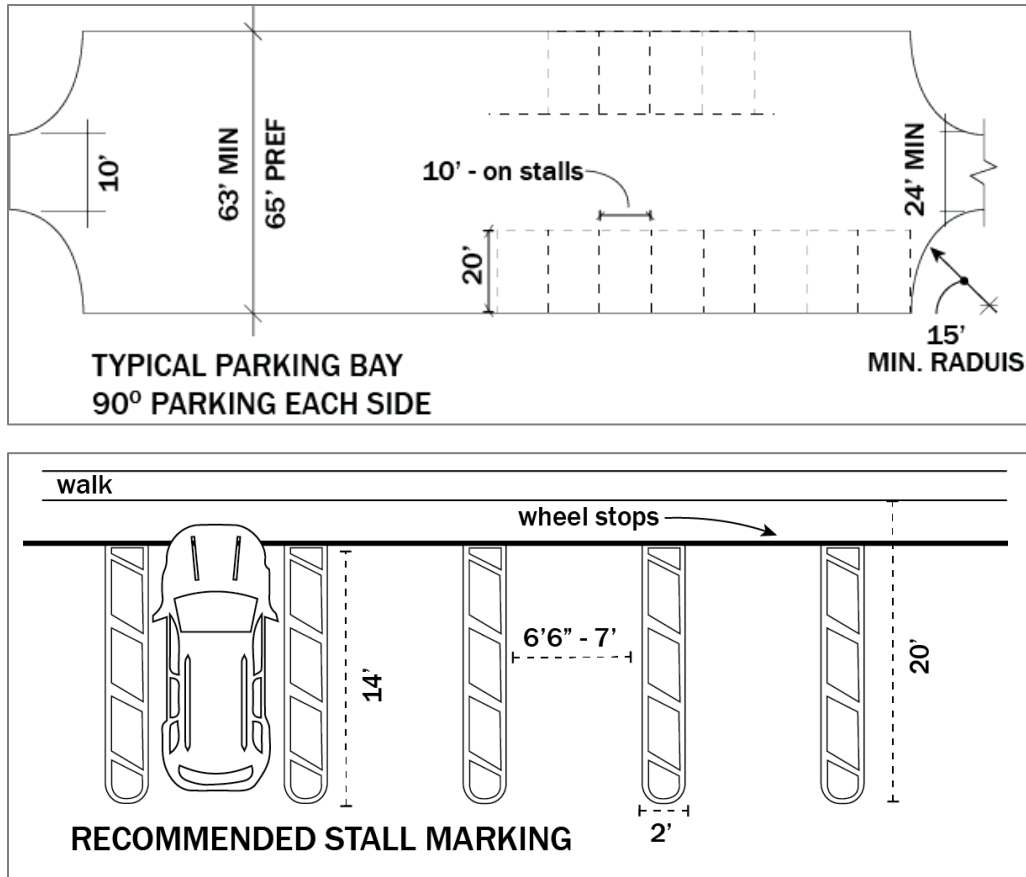

**F. Landscaping**

1. A Landscape Plan shall be completed for any new [development](#) project requiring a site development permit and detail the site showing all natural and man-made features of the site. Proposed landscaping shall be shown on the site development plan or on a separate landscaping plan and must include the following:
  - a. Existing and proposed landscaping features should be identified as to location, common name, botanical name, and size.
  - b. Fences, walls, terraces, paving, berms, and all other man-made [structures](#) shall be identified as to location, materials and height.
  - c. A minimum of one tree per 2,000 square feet of gross [lot area](#), except in the C-1 District between 4th and 9th Avenues, shall be provided.
  - d. Trees shall have a minimum caliper of 1-1/2" for deciduous and five-foot minimum height for coniferous species. Trees should be located so that they will not infringe on solar access and views of adjoining properties or block vehicular sight lines to public [streets](#).
  - e. Retention of existing trees and ground cover on the property is encouraged. These will be counted towards the minimum standards.

f. Xeriscape landscaping and drip irrigation are encouraged. If irrigation is proposed, water line and plumbing details must be included on site development plans and building permit plans.

g. Landscaping of public rights-of-way may extend to the curb line of adjacent City owned right-of-way consistent with a permit pursuant to Chapter 13 of the Ouray Municipal Code.

**G. Street Numbering**

1. All [development](#) is required to number and display [street](#) addresses at all times consistent with the adopted City policy. All numbers must be approved by City staff prior to posting.

**H. Snow Storage**

2. Snow accumulation occurs within the City and all development must plan for and manage this occurrence. All site development and activities must provide for on-[site](#) snow storage in conjunction with the following criteria:

a. For planning purposes, one (1) square foot of snow storage space is generally necessary for each three (3) square feet of public or private [land](#) to be cleared except public [streets](#).

b. Such snow storage areas should be graded so drainage for these areas drains away from adjacent residential building sites.

c. Site developments should not be designed so that snow storage will be solved by hauling snow off site.

d. Snow storage should not interfere with intersection views, traffic, or signage.

e. Snow storage shall not be located on wetlands, unless otherwise agreed by the City.

**I. Public Improvements - Sidewalks**

1. Pedestrian access is required for all development, including the construction of a single family dwelling on an existing lot. All developments shall be required to construct sidewalks in accordance with City standards. No certificate of occupancy shall be issued until the requirements of this section are met.

**J. Radiation Survey**

1. Radiation surveys may be ordered at the discretion of the City. Such surveys shall conform with current standards and procedures identified by the Colorado Department of Health, Environmental Protection Agency, the Atomic Energy Commission and/or other designated agencies.

## Section 7-9 Subdivision Design and Improvement Standards

### A. Purpose

1. [Subdivision](#) development regulations are essential for orderly and controlled development within, and adjoining, the City of Ouray. These regulations ensure development is consistent with community plans and constructed to established and required standards. These standards also ensure quality, safety and the overall welfare of property owners, and citizens or customers who use or frequent these developments. Quality [development](#) should benefit everyone.

### B. General

#### 1. Control

a. All development plans or proposals shall be subject to the provisions of these regulations, whether a [plat](#) is filed or not.

b. All [final plats](#) required by this Section shall be filed and recorded following approval by City Council and after any conditions have been met.

#### 2. Jurisdiction

a. These regulations are applicable within the following areas:

i. All [land](#) located within the legal, corporate boundaries of the City of Ouray.

ii. Where applicable, any quasi-municipal corporation located partially or entirely within its boundaries pursuant to Section 18(2)(a) and 2(b) of Article XIV of the Colorado Constitution.

#### 3. Liability

a. These regulations shall not create any liability on the part of the City or any officer or employee thereof arising from reliance upon these regulations or any administrative act or failure to act pursuant to these regulations.

#### 4. Applicability

a. These regulations also apply to [Planned Unit Developments](#) which may be considered and processed in accordance with Section 7-5-D-5.

### C. Subdivision Design

#### 1. Minimum Standards

a. All improvements shall be constructed in accordance with the minimum standards set forth below and other applicable City Specifications and Design Standards for Infrastructure Construction and other applicable City ordinances or regulations. All public and private improvements shall be in [substantial conformity](#) with the [preliminary plat](#) as approved, the City [Master Plan](#) and amendments thereto, and in accordance with standard engineering and construction practices.

b. The City may allow a deviation from these design standards under the following circumstances:

- i. The deviation is not intended to merely reduce the cost to the applicant, and will not adversely affect the quality of the [subdivision](#) or the public health, safety, and welfare, and will not undermine the purposes of these regulations, or be substantially inconsistent with the City’s Master Plan, and
  - ii. The alternative design is necessary to reasonably accommodate development of unusually shaped parcels or [parcels](#) with waterways or other limiting topographical features, or
  - iii. The alternative design will more effectively implement the purposes of these regulations and the public health, safety, and welfare, or
  - iv. The alternative design is superior in functionality, durability, or utility to the City, or
  - v. The alternative design will conform to existing adequate public improvements within the subdivision previously approved by the City.
2. General Design Considerations
  - a. A proposed [subdivision](#) shall comply with the [Master Plan](#).
  - b. A subdivision shall be designed such that no undue burden is placed on the City street system, the storm drainage system, other municipal facilities and utilities and services on or adjacent to the property. Site drainage must be addressed and shall not interfere with natural drainage. Mitigation of natural hazards will be required when identified.
  - c. A proposed subdivision shall be designed in such a manner as to be coordinated with adjoining subdivisions with respect to alignment of [streets](#) and utility and drainage easements, rights-of-way, and reservation of [open spaces](#).
  - d. Subdivision design and layout shall give consideration to the preservation of wooded areas, streams, and other desirable natural landscape features.
3. Streets and Circulation
  - a. Arrangement of Streets
    - i. Streets shall be arranged and designed to coordinate with and conform to existing or planned streets, topographic conditions, public convenience, and safety, and to accommodate the proposed use of land to be served.
    - ii. Street arrangement shall provide for the continuation or projection of streets on adjacent land, if appropriate. This requirement shall not be applicable where such extension would be prevented by topography or other physical conditions or where such connection of streets with existing or probable future streets is deemed by the Planning Commission to be unnecessary for the advantageous development of adjacent property.
  - b. Closed-End Streets
    - i. Closed-end streets shall be provided with circular turnarounds or T-shaped or Y shaped termini, with minimum dimensions as follows:

1. Circular turnarounds shall have a minimum outside right-of-way diameter of eighty (80) feet. A smaller diameter may be allowed if approved by the Planning Commission and shall at a minimum be sufficient for turn-around of any vehicle which may reasonably make use of such street, and all fire department vehicles.
2. A T-shaped or Y-shaped terminus may be provided in mountainside subdivisions as an alternative to the circular turn-around. Where provided, the wings of such T or Y shall be at least 20 feet deep measured from the street boundary and at least 12 feet wide, exclusive of [parking spaces](#).

c. Intersections

- i. [Streets](#) shall intersect as nearly as possible at right angles. No street shall intersect any other street at an include angle of less than 45 degrees.

d. Minimum public street right-of-way widths shall be as follows:

i. Actual Street Width

<b>Street Type</b>	<b>Including Parking</b>	<b>Right-of-way</b>
1. Major Street	70 feet	100 feet
2. Minor Street	30 feet	54 feet
3. <a href="#">Alley</a>	N/A	20 feet

e. Vertical Alignment

- i. No vertical grade shall be less than 0.5 percent in order to facilitate adequate drainage.
- ii. The maximum percent of street grade shall be ten (10) percent, except as provided in (iii) below.
- iii. The street grade requirement set forth in (ii) above, may be waived by the City upon submission of engineering studies indicating that street construction for the development cannot meet the required grade. The City Council may not accept such streets for maintenance and a statement to this effect may appear on the [final plat](#).

f. Visibility Requirements

- i. No substantial impediment to visibility between the heights of three (3) and (8) feet shall be created or maintained at street intersections.

g. Street Names

- i. All street names that do not duplicate the name of any other street name in the City or County of Ouray, shall be approved by the City Council. New streets which are extensions of, or which are in alignment with existing streets shall bear the names of these existing streets.

h. Private Streets

i. [Private Streets](#), unless approved by PUD, shall not be allowed. Private access easements serving only one (1) [lot](#) may be allowed, provided that no such easement shall be less than 20 feet in width.

i. The City may require any street, sidewalk and related infrastructure, on a steep [slope](#), or where there is any evidence to suspect problems due to instability, or other adverse soil conditions, to be owned and maintained by the lot owners or an owners' association, or may require an extended warranty of maintenance and repair from the applicant. A slope easement shall be dedicated to the City to accommodate the area of any cut or fill off of the right-of-way and an additional ten (10) feet beyond the cut or fill. Such easement shall allow the City to maintain the slope, cut and fill, and street improvements. Additionally, such easements may be accompanied by a [plat](#) note holding the City harmless on account of any sloughing or disturbance due to maintenance of the cut or fill.

j. Utility Easements

i. Utility easements shall be a minimum of 20 feet centered on lot lines and 10 feet on either side of a street, where appropriate.

4. Blocks

a. The lengths, widths and shapes of blocks shall be determined as follows:

i. Provision for adequate [building sites](#) suitable to the special needs of the type of [use](#) contemplated.

ii. Need for convenient access, control, and safety for vehicular and pedestrian traffic circulation.

iii. Limitations of topography.

5. Lots

a. In general, [lot area](#), width, depth, shape, and orientation shall be appropriate for the location of the [subdivision](#) and [use](#) contemplated and shall be compatible with the terrain and topography. All [lots](#) shall conform to all City Zoning Regulations.

b. Depth and width of lots for multiple-family, public accommodations and commercial purposes shall be adequate to provide for off-street parking and service areas required by the type of use and [development](#) contemplated. All parking shall comply with all City Zoning Regulations.

c. Each lot shall have satisfactory access to a public or approved private street. Satisfactory access must include adequate clearance and slope for emergency vehicle access. If the proposed lot does not abut a public street, the applicant shall provide a 20-foot access easement or right-of-way from the lot to a public street.

d. Insofar as possible, all lot lines shall be at right angles to straight streets and radial to curved streets.

e. All lots and parcels created will have access to the State highway system in accordance with the State Highway Access Code.

6. Water, Fire Protection and Sewer Systems

a. Water, fire protection and sewer systems shall be designed by a registered engineer and constructed in accordance with standard engineering practices to City Standard Specifications for Infrastructure Construction. All improvements shall be of sufficient size and design to adequately supply water, sewer, and fire protection to each building to be constructed in the development.

b. Fire hydrants shall be installed at street intersections, or as necessary, to insure that no building is located a distance in excess of 300 feet from the nearest fire hydrant.

7. Curb, Gutter, and Sidewalks

a. Curb, gutter, and sidewalks shall be designed and constructed in accordance with City Standard Specifications for Infrastructure Construction.

8. Drainage

a. Drainage systems shall be provided in accordance with the approved [final plat](#) and conform to the City Standard Specifications for Infrastructure Construction. The flow of water shall be directed to natural drainage ways as they exist and utilizing a minimum 20-foot easement. Where water courses or ditches traverse the subdivision, lots and improvements shall be designed and provided to protect against flooding in accordance with the City's Floodplain Regulations.

b. The storm drainage system shall be of sufficient size and design to transport all developed drainage from within the subdivision or development while also conveying historic site storm water or runoff passing through the subdivision or development from adjacent areas.

c. No drainage system shall be designed that increases drainage or discharge to property outside the subdivision unless approved by the City Council. This may also require approval from any affected property owners.

9. Hazard Mitigation

a. Engineering Geology Report

i. An Engineer Geology Report (EGR) prepared by a registered professional engineer or a qualified geologist shall be required on properties:

1. Identified as hazard areas in State of Colorado Special Publication 30, except as modified by LOMRs issued by FEMA dated November 9, 1998 and December 9, 2005;

2. On property or adjacent areas that have been subject to significant events as a result of a [geologic condition](#) within the past 100 years; or

3. On properties proposed for [development](#) that have [slopes](#) of 3 vertical to 1 horizontal or greater.

- ii. An EGR shall include an adequate description of the hazards or geologic conditions of the site, conclusions and recommendations regarding the effect of hazards and/or geologic conditions on the proposed site development or activity, an opinion of the adequacy for the intended use of sites to be developed, as affected by hazards and/or geologic conditions. The EGR must also provide detailed construction and maintenance plans for each mitigation measure. It shall be the responsibility of the Applicant to identify and mitigate natural hazards according to guidelines set forth by the State of Colorado in Special Publications 6 and 30, Guidelines and Criteria for Identification and Land-Use Controls of Geologic Hazard and Mineral Resources Areas. The Applicant may also refer to the Colorado Geologic Survey's Engineering Geology Report Guidelines in order to provide an adequate EGR as required by this Code. However, nothing in the Engineering Geology Report Guidelines shall have control over this Code or the determination by the City of the adequacy of the submitted EGR.
  - iii. The City reserves the right to refer the EGR to a professional engineer or qualified geologist or to the Colorado Geological Survey or similar agency for review.
  - iv. If the Applicant does not submit an EGR, the Applicant must provide an explanation written and certified by a professional engineer or qualified geologist stating the reasons for the failure to submit the Report. The City reserves the right to submit the application to an engineer to determine whether an EGR is required. Failure to submit an EGR where the City determines one is required shall be grounds for denial of a permit application.
  - v. Where hazards and/or geologic conditions are identified in the EGR that could adversely affect the development, the Applicant must take the steps necessary to mitigate the hazards and/or geological conditions.
  - vi. Mitigation shall be in accordance with recommendations made by a registered engineer or qualified geologist and detailed in the EGR if the EGR meets the requirements of the City. The City reserves the right to refer the EGR to a professional engineer or qualified geologist or to the Colorado Geological Survey or similar agency for review. The City further reserves the right to impose conditions for required mitigation based upon the recommendations of the agency or individual to which the EGR or proposed subdivision is referred.
- b. The name, address and telephone number of all surface owners, mineral owners and lessees of mineral rights as their names appear upon the plats or records in the Ouray County Clerk's Office. Addresses shall be used as listed most recently in a directory in general use or as on the tax records of Ouray County. Proof of mailing to the above of a notice of the hearing shall be required.
  - c. Evidence that provision has been made for gas, electric and phone service pursuant to C.R.S. §31-23-214(3).
  - d. The property owner will indemnify, defend, and save harmless the City, its agents, officers, and employees from and against any and all liability, expenses including defense costs and legal fees, and claims for damages of any nature whatsoever, including bodily injury, death, or property damage arising from or connected with any activity related to these hazards, [geologic](#)

[conditions](#) and mitigation measures. A release signed by the property owner on forms approved by the [City](#) shall be recorded with the Ouray County Clerk and Recorder. The release shall be included in a [plat](#) note.

#### 10. Snow Storage

- a. All snow storage necessary for the [subdivision](#) shall be provided within the subdivision.
- b. For planning purposes, one (1) square foot of snow storage space is necessary for each three (3) square feet of public or private land to be cleared, except public [streets](#).
- c. Such snow storage areas should be graded so drainage for these areas is away from adjacent [building sites](#) or other [structures](#) and improvements.
- d. Developments are not permitted to address snow storage requirements with snow removal or snow hauling plans.
- e. Snow storage should not interfere with intersection views, traffic, or signage.
- f. Snow storage shall not be located on wetlands, unless otherwise agreed by the City.

#### 11. Plat Notes

- a. Plat notes and covenants may be required by the City as appropriate to implement the provisions of these regulations, and to hold the City harmless from risks associated with natural hazards and conditions, or other risks. Plat notes shall denote any and all conditions or allowances approved by the City Council.
- b. Plat notes on prior City plats are superseded unless reiterated or incorporated by reference on the [plat](#).
- c. Plat notes may also be required in the following circumstances:
  - i. To set out maintenance requirements of the lot owners, enforceable by the [City](#), for various improvements such as drainage, detention and retention facilities, commonly owned areas, [private streets](#), and other private improvements.
  - ii. To require engineered foundations in areas of steep [slopes](#) or other soil conditions together with provisions giving notice of, and holding the City harmless from, potential problems due to slopes, cut and fill areas, adverse soil conditions or natural hazards.

#### 12. Monuments

- a. In addition to the requirements of C.R.S. §38-51-105, all lots shall be monumented, and monuments shall be placed at all street intersections, at all points where street lines intersect the exterior boundaries of the subdivision, at angle points and points of curve in each [street](#), and at points of change of direction in the exterior boundaries of the [subdivision](#).

### **D. Subdivision Dedication Requirements**

1. Reserved.

## 2. Parks, Trails, Open Space, Recreation Facilities, Common Areas

- a. The provision for parks, trails, [open space](#), common areas, and recreation facilities shall conform to the minimum design standards as set forth herein, and the City specifications for parks.
- b. All non-public common areas or elements and open spaces will be owned, located, constructed, installed, and maintained in perpetuity, with appropriate City approved [plat](#) restrictions on [use](#) and covenants for ownership and maintenance. All non-public common areas shall be located, constructed, and installed in compliance with plans as reviewed and approved pursuant to these regulations.
- c. Public parks, sidewalks, bike paths, recreation trails, pedestrian walkways and parkways shall be provided consistent with the [Master Plan](#), integrated with existing and planned sidewalks, bike paths, parks, recreation trails, pedestrian walkways, and parkways whenever feasible and shall be designed and constructed in accordance with City design and construction standards.
- d. Unless otherwise authorized, areas which will be available for use by the public in addition to the residents of any subdivision shall be conveyed by easement or [dedication](#) to the [City](#). Sidewalk and recreation trails shall conform to the Americans with Disabilities Act where applicable.
- e. Unless otherwise authorized, parks developed in accordance with City standards and specifications at least two acres in size, shall be available for use by the public and shall be dedicated to the City. Parks of less than two acres shall be owned and maintained under common ownership and must be a minimum of one acre in size.
- f. Natural watercourses shall be developed and preserved consistent with City Floodplain Management Regulations, Storm Drainage Requirements and Federal Clean Water Act Section 404 Permit requirements, to minimize safety, environmental, and other hazards, and shall be integrated with the City's Master Plan for such watercourses whenever feasible. Parks, open spaces, and trails shall be sited in floodplains instead of developable areas, when possible.
- g. Developed and dedicated parks shall be provided at the [applicant's](#) expense for all subdivisions, except lot splits and replats as defined in these regulations, or those with plat restrictions prohibiting the public. In accordance with the National Parks Standard adopted by the City, applicant shall dedicate developed park [land](#) based upon a formula of .025 acres per [dwelling unit](#).
- h. Developed park land shall require submittal and approval of a park plan during the preliminary plat process. The plan shall address grading and topsoil preparation, access, irrigation system, park access, equipment, and landscape plantings. This plan must be approved by the City and conditional with the [preliminary plat](#) approval.
- i. Subdivisions where the [dedication](#) of park [land](#) or [open space](#) is not practicable, such as subdivisions involving small land area or few lots, or other unusual circumstances, or when the required acreage computed by the formula of paragraph (g) above is less than one acre, the City

may require or accept a cash payment in lieu of construction of developed parks based upon the City's average park development costs and land acquisition costs as stated below. Payment in lieu amount shall be as shown on the adopted fee schedule, which may be revised from time to time.

- i. Such payments shall be collected prior to recording the [final plat](#) and used by the City for park acquisition and development purposes. Such payment may be subject to a City discount established by City Council from time to time (initially \$414 per [lot](#) or unit) to recognize a City-wide contribution toward regional parks.
- ii. The City may also require [development](#) of only a portion of the park requirement as appropriate to meet the need for a neighborhood park and require a payment in lieu of the remainder of the obligation to be utilized by the City for community parks. In determining which of the combination of the above policies to implement the City will consider the following: The size of the development and its adequacy for accommodating a suitable public use site; existing parks and other public uses in the area; the topography, geology, and location of [land](#) in the subdivision available for [dedication](#); the needs of the people in the [subdivision](#); and any other appropriate factors.
- j. When authorized by the City, requirements for developed parkland may be partially or wholly met, all or in part, by alternative provision of public access open space areas such as riparian habitat, floodplains, wetlands habitat, view corridors or trails. The appraised land value of such an alternative dedication shall be equal to the total value of the developed park [land](#) which it replaces based on values as calculated pursuant to paragraph above.

#### **E. Subdivision Improvements and Development Agreements**

1. General Requirement
  - a. [Street](#) and utility improvements shall be provided in each new [subdivision](#) in accordance with the standards and requirements of City Standard Specifications for Infrastructure Construction, and at the expense of the applicant.
2. Right-of-Way Improvements
  - a. Bridges, culverts, open drainage channels and satisfactory surfacing shall be provided on each right-of-way in each subdivision. Such improvements shall be constructed to City Standard Specifications for Infrastructure Construction as approved by the City.
3. Utility Improvements
  - a. The following utility improvements shall be installed in each new subdivision in accordance with City Standard Specifications for Infrastructure Construction hereinafter specified:
4. Storm drainage system
  - a. Conduits, drains, ditches, storm sewers and other drainage improvements may be required where deemed necessary by the Planning Commission and City.
5. Potable Water System

a. The potable water system shall be connected to the water system of the City of Ouray. Construction details shall be in accordance with any specifications promulgated by the City of Ouray. All water system installation shall be subject to all City ordinances and agreements.

6. Fire Hydrants

a. Ouray standard fire hydrants shall be installed.

7. Sanitary Sewage System

a. The sanitary sewage system shall be connected to the sanitary sewage system of the City of Ouray and shall be of sufficient size and design to collect all sewage from all proposed or probable [structures](#) in the [development](#).

8. Installation of Over-Sized Utilities and Improvements

a. All water service required to serve a [subdivision](#), including cross-connecting mains, shall be installed at the expense of the applicant. Unless otherwise specifically provided in these regulations, the applicant shall install mains to the farthest point of the subdivision.

b. When an applicant is required to extend existing water mains, the applicant shall pay the costs of original construction. The size of the mains shall be determined by the City Council on the recommendation of the Planning Commission and Public Works Director.

c. Nothing in this Subsection shall preclude the City Council from entering into an agreement with the applicant relating to the costs of extension of utilities.

d. All required extensions of the sanitary sewer system shall be financed by the applicant unless otherwise provided by the City.

9. Other Improvements

a. The following other improvements are required:

i. Telephone and electric service lines, television, fiber internet, and similar utility cables and installations shall be placed underground unless otherwise approved by the City. Electric transmission and distribution feeder lines and communications trunk and feeder lines and appurtenances necessary thereto may be placed above ground. Transformers, switching boxes, terminal boxes, meter cabinets, pedestal ducts and other facilities necessarily appurtenant to underground utilities may also be placed aboveground.

ii. Permanent reference monuments made of stone, metal, or concrete.

iii. Street signs, stop signs, or similar traffic control devices.

iv. Streetlights must be shielded so that the light source is not directly visible off the premises and meet International Dark-Sky Association standards.

v. Curb and gutter shall be provided along paved streets and where required by City specifications. Concrete sidewalk shall be provided along all abutting streets except when the Planning Commission and City Council determine that sidewalk is necessary on only one

side of a local [street](#) because of the shortness of the street, unusual topographical factors or other circumstances which alleviate the need for such sidewalk. In those cases where the proper grade of the sidewalk cannot be determined, the Planning Commission and City Council may authorize the execution and recording of an agreement on forms provided by the City to join in an improvement district to install the sidewalk at such time as sidewalk construction becomes feasible instead of immediate construction.

vi. Parks, [open space](#), bike paths, pedestrian, and recreation trails in accordance with the City's adopted Parks and Trails [Master Plan](#).

vii. Improvements to mitigate identified natural hazards.

viii. Offsite improvements, when it is determined by the City Council after recommendation by the Planning Commission that such are necessary to serve the subdivision, mitigate the impacts of the [subdivision](#) and to provide for the public health and safety shall be provided at the expense of the applicant.

ix. CDOT required intersection and driveway improvements.

#### 10. Subdivision Improvements Agreement

a. A [subdivision improvements agreement](#) on forms approved by the City shall be recorded with any final plat for all [subdivision](#) improvements. The [applicant](#) may wish to have the final plat approved prior to the installation, inspection and approval of all required improvements, however financial instruments must be provided to guarantee the completion of all improvements within four (4) years after approval of the [final plat](#) and incorporated into the Subdivision Improvements Agreement. Financial instruments shall be in the form of the following:

i. A [subdivision](#) improvements and lien agreement placing an adequate lien on subdivided [lots](#), with an escrow account with the City into which the applicant shall pay, prior to the sale of any lot in the subdivision, an amount to be verified by the City (with cost estimates provided by the applicant), equal to one hundred fifty percent (150%) of the pro rata cost to complete the improvements necessary to serve that lot; or

ii. A cash escrow deposited with the City or a clean irrevocable letter of credit in an amount to be verified by the City (with cost estimates provided by the applicant) equal to one hundred and fifty percent (150%) of the pro rata cost to complete the subdivision improvements necessary to serve the subdivision.

iii. Security shall not be required for payment in lieu of parks provided in Subsection 7-9-D-2-i, as such money payment shall be collected prior to recording the final plat.

b. Funds in any escrow account shall be returned to the [applicant](#) upon the completion of the improvement secured, submission of record drawings, and acceptance by the City.

c. The applicant shall complete all improvements by any stated completion date or within four (4) years of the approval of the [final plat](#) by the City. In the event that all required improvements are not completed, inspected, and approved within four (4) years of the date of the approval of

the final plat by the City, the City may withhold further building or occupancy permits, or water taps or sewer taps in such subdivision until such improvements are completed. It shall then be unlawful to sell any further [lots](#) in the subdivision until all improvements are completed. The City may take any other lawful action to enforce completion of the improvements.

d. The City Council may authorize extensions of time to complete all improvements beyond the four (4) year limitation as set forth herein.

## Section 7-10 Annexation

### A. Purpose

1. The purpose of this Section is to define the annexation process for annexation of land into the City in accordance with the Colorado Municipal Annexation Act of 1965, as amended, and this Land Use Code.
2. Responsibilities of Applicant
  - a. In addition to other duties imposed upon all applicants by this Code and the Colorado Municipal Annexation Act of 1965, all applicants shall have the following responsibilities:
    - i. The applicant is responsible for having a representative at all meetings where the request is reviewed. Failure to have a representative present will be cause to have the item withdrawn from the agenda of that meeting.
    - ii. The applicant shall consult with the Administrator to discuss any special conditions pertaining to the annexation and to obtain an annexation petition.
    - iii. Municipal Annexation Act of 1965, all applicants shall have the following responsibilities:
      1. The applicant is responsible for having a representative at all meetings where the request is reviewed. Failure to have a representative present will be cause to have the item withdrawn from the agenda of that meeting.
      2. The applicant shall consult with the Administrator to discuss any special conditions pertaining to the annexation and to obtain an annexation petition.
3. Annexation Process
  - a. At least 15 days prior to the presentation of any annexation petition to the City Council, the applicant shall submit to the City an annexation petition, the annexation fee as set forth on the City's Fee Schedule, an annexation map and plan, and all required supportive information defined by the Administrator.
    - i. The Administrator shall review all documents submitted for completeness and accuracy. If all documents are complete and accurate, the Administrator shall submit the annexation petition to the City Clerk.
    - ii. The City Clerk shall present the annexation petition and a resolution initiating annexation proceedings to the City Council, which shall establish a date for a public hearing. Upon the establishment of a public hearing date, the City Clerk shall give appropriate public notice in accordance with the Colorado Municipal Annexation Act of 1965, as amended. The Administrator shall forward copies of the annexation petition and the resolution initiating the annexation procedure by certified mail to the Clerk of the Board of County Commissioners and to the County Attorney. Copies of the annexation petition and the resolution initiating the annexation procedure shall also be sent by certified mail to any school district or special district having territory within the annexed area. These copies shall be sent at least 25 days prior to the public hearing.
    - iii. Upon acceptance of the annexation petition by the City Council, the Administrator shall furnish to the entities listed below copies of the annexation map and plan. The

Administrator may also submit copies of the annexation map and plan to additional interested entities or agencies as deemed necessary. All notified entities shall be advised of the scheduled hearing date and details that define the date in which any objections to the annexation map and plan must be submitted to the City in writing.

1. Telephone companies
2. Franchise utility companies
3. City Engineer
4. Fire Department
5. [City](#) Public Works Department
6. State Highway Department
7. The Planning Commission shall review the annexation map and plan, and zoning request at a public hearing and shall submit a written recommendation to the City Council following their review.

#### 4. Annexation Map

a. All annexation maps shall have an engineer's scale (minimum scale to be one inch represents 100 feet) and shall be on a reproducible medium with outer dimensions of 24 inches by 36 inches. The annexation map shall contain the following information:

- i. The date of preparation, the scale and a symbol designating true north.
- ii. The name of the annexation.
- iii. The names, addresses and phone numbers of the applicant and the firm or [person](#) responsible for preparing the annexation map.
- iv. The legal description.
- v. Distinction of the boundary that is contiguous to the City and the length of the same.  
Lot and block numbers if the area is already platted.
- vi. Existing and proposed easements and rights-of-way.
- vii. Existing and requested zoning and acreage of each requested zone.
- viii. Ownership of all parcels within and adjacent to the annexation.
- ix. Appropriate certification blocks as directed by the Administrator.

#### 5. Annexation Plan

a. All annexation plans shall have an engineer's scale (minimum scale to be one inch represents 100 feet) and shall be on a reproducible medium with outer dimensions of 24 inches by 36 inches. The annexation plan shall contain the following information:

- i. The date or preparation, the scale and a symbol designating true north.
- ii. The name or the annexation.

- iii. The names, addresses and phone numbers of the [applicant](#) and the firm or [person](#) responsible for preparing the annexation plan.
  - iv. Existing and proposed easements and rights-of-way.
  - v. Existing and proposed [block](#) numbers and [lot](#) numbers with dimensions.
  - vi. Proposed gross and net lot [density](#).
  - vii. Existing watercourses with adequate casements for flood control.
  - viii. Designation of all public [sites](#) to be reserved and dedicated.
  - ix. Existing two-foot contours.
  - x. Appropriate certification blocks as directed by the Administrator.
  - xi. Supporting Information: The following supportive information shall be submitted with the annexation map and plan:
    1. Soils description and limitation.
    2. Preliminary utility plan.
    3. Mailing addresses of all property owners within 300 feet of the annexation.
    4. Affidavits concerning the amount and historical [use](#) of all water rights owned.
    5. Vicinity map with a radius of one and one-half miles, at a minimum scale of one inch represents 2,000 feet.
    6. Statement of community need for the proposed annexation and zoning.
    7. For all annexations more than ten (10) acres, the applicant shall obtain from the school district governing the area to be annexed a statement of the effect of the annexation upon the school district, including an estimate of the number of students generated by the proposed annexation and the capital construction required to educate such students.
6. Annexation Impact Report
- a. For all annexations more than ten (10) acres, the City shall require the applicant to prepare an impact report regarding the proposed annexation not less than 25 days before the date of the annexation hearing. One copy of the impact report shall be filed with the Board of County Commissioners within five days thereafter. The preparation and filing of the annexation impact report may be waived upon approval of the Board of County Commissioners.
  - b. The annexation impact report shall include the following:
    - i. A map or maps of the City and adjacent territory showing the following information:
      1. The present and proposed boundaries of the City in the vicinity of the proposed annexation.

2. The present [streets](#), major trunk water lines, sewer interceptors and outfalls, other utility lines and ditches and the proposed extension of such streets and utility lines in the vicinity of the proposed annexation.

3. The existing and proposed land use pattern in the areas to be annexed.

ii. A copy of any draft or final annexation agreement, if available.

iii. A statement of the City's plans for extending or providing for municipal services within the area to be annexed.

iv. A statement of the City's plans for the financing of municipal services to be extended into the area to be annexed.

v. A statement identifying all existing districts within the area to be annexed.

vi. A statement of the effect of the annexation upon the school district governing the area to be annexed, as more fully set forth above.

#### 7. Annexation Agreement

a. The City and the annexation petitioner shall complete a detailed annexation agreement that stipulates all agreements. The City will use an annexation agreement template which will guide the discussion and define specific criteria. The final annexation agreement becomes an exhibit in the annexation ordinance defined in Section 7-10-A-8.

#### 8. Annexation Ordinance

a. Upon the submission of documentation in accordance with this Section and upon compliance with the notice and hearing requirements as set forth in the Colorado Municipal Annexation Act of 1965, as amended, the City Council may consider the approval of an ordinance annexing the subject property to the City. In the event the City Council considers and disapproves such ordinance, a similar request may not be heard for a period of one (1) year from the date of denial.

#### 9. Final Submission and Filing

a. In the event the City Council approves an annexation ordinance, the annexation petitioner shall submit to the Administrator one mylar copy of the final annexation map and plan within ten (10) days of the effective date of the annexation ordinance. Additionally, a signed annexation agreement shall be submitted to the Administrator. The adopting ordinance, annexation map and plan and the annexation agreement are then recorded by the City Clerk in the Ouray County Clerk and Records office.

**CHAPTER 8**  
**Sign Code**

**Table of Contents**

<b>Section 8-1</b>	<b>General Provisions.....</b>	<b>2</b>
<b>Section 8-2</b>	<b>Definitions.....</b>	<b>3</b>
<b>Section 8-3</b>	<b>Sign Permits.....</b>	<b>5</b>
A	Signs Allowed Without a Permit.....	5
B	Temporary Signs on Public Property.....	5
C	Signs Requiring Permits.....	6
<b>Section 8-4</b>	<b>Performance Criteria.....</b>	<b>7</b>
<b>Section 8-5</b>	<b>Prohibited Signs.....</b>	<b>11</b>
<b>Section 8-6</b>	<b>Nonconforming Signs.....</b>	<b>12</b>
<b>Section 8-7</b>	<b>Sign Enforcement.....</b>	<b>13</b>

## **Section 8-1    General Provisions**

### **A. Purpose**

The purpose of this Chapter is to:

1. Promote the public health, safety, and welfare.
2. Enhance the economy, business, and industry through efficient communication.
3. Facilitate communication and wayfinding for residents, businesses, and guests.
4. Improve the quality of signage in the City of Ouray.
5. Promote visual harmony with the natural beauty and character of the City of Ouray.
6. Minimize light pollution from signs.
7. Prevention sign clutter that may create public safety hazards through visual distraction, obstructed views, or physical obstructions.

## Section 8-2 Definitions

A. The following definitions apply throughout this Chapter, unless the context clearly requires otherwise:

1. **A-Frame sign** consists of two (2) sign faces placed together at an angle to form an "A" shape structure which tapers from a wide base to a narrow top. A-frame signs are sometimes referred to as sandwich board signs.

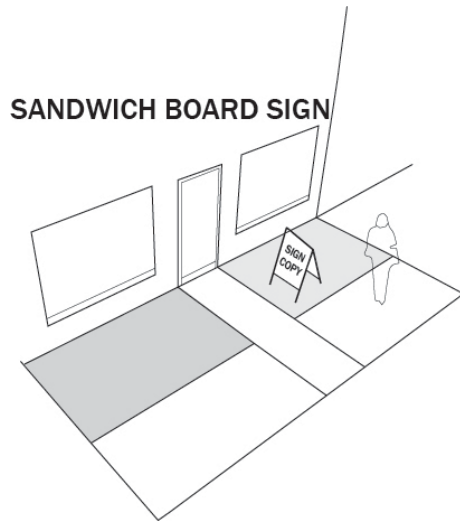

2. **Banner** is a sign with or without characters, letters, illustrations, or ornamentalations applied to cloth, paper, flexible plastic, or fabric of any kind with only such material for backing. A banner may be easily folded or rolled.
3. **Flag** is made of cloth, vinyl or a similar pliant material that is attached on one side to a flagpole and is designed to flow in the wind.
4. **Off-Premise Sign** is any sign advertising a use or establishment which is not located on the real property the off-premises sign is located on.
5. **Sign** is any device, display, or structure which is visible from a public place and that has words, letters, figures, designs, symbols, logos, illumination, or projected images. This definition does not include architectural elements incorporated into the structure or facade of a building. For the purposes of this sign code, "signs" do not include those only visible from the inside of a building; nor do "signs" include those held by or attached to a person or a mobile object.
6. **Sign Face Area** shall include the area of the device, structure or display upon which the sign message is shown.
7. **Temporary Signs** are constructed of cloth, canvas, vinyl, paper, plywood, fabric, plastic, or other lightweight material that is neither permanently installed in the ground nor permanently affixed to a building or structure that is permanently installed in the ground. The term "temporary sign" includes, but is not limited to, A-frame signs, lawn signs, and inflatable signs. The term "temporary sign" does not include flags, and signs that are intended to regularly move, such as motorized signs.

8. **Total Sign Face Area** shall be the sum of the area of all signs on a structure or at a business location. Signs allowed without a permit shall not be included in this calculation. All other signs, unless exempted by this Chapter, shall be included in a calculation of total sign face area.

9. **Window Sign** means a sign attached to or painted on the window of a building.

**WINDOW SIGN**

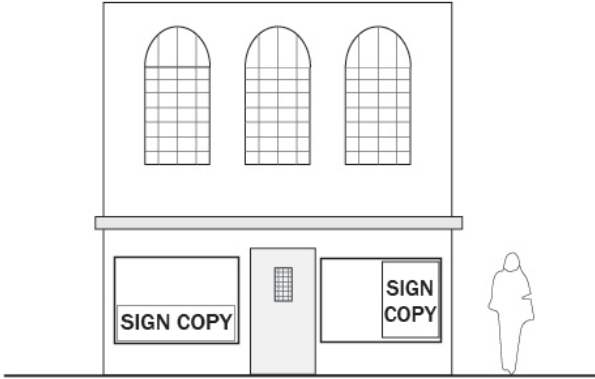

## Section 8-3 Sign Permits

### A. Signs Allowed Without a Permit

The following signs may be erected, maintained, and used without a sign permit.

1. [Window signs](#) which do not exceed two (2) square feet each and have an aggregate [sign face area](#) of eight (8) square feet per window or a maximum of 25% window area, whichever is smaller, for the premises upon which they are located.
2. Signs located within buildings.
3. Works of art unless they are used to convey speech.
4. All [temporary signs](#) on private residential property with maximum sign face of four (4) square feet per sign face side.
5. All temporary signs on private commercial and industrial property.
6. All inflatable signs that are safely attached to the ground or a building.
7. Any sign not visible from a public right-of-way.
8. One public notice bulletin board per street frontage with an aggregate sign face area of ten (10) square feet, for any commercial or industrial establishment where the same are located on the premises of said establishments.
9. Two (2) [flags](#) per 25 feet of lot frontage and 25 square feet each may be mounted on any single building or premises. No part of the flag may hang over a roadway or be lower than seven (7) feet above the public right-of-way.
10. [Banners](#) for events that are located off-premises and visible from the U.S. Highway 550 right-of-way that do not exceed eight (8) square feet of total sign area and are erected no more than ten (10) days prior to the opening of the event. Such banners shall be removed no more than forty-eight (48) hours after the event is over.
11. All lightweight signs, decals, stickers, or paint, placed on vehicles, with the permission of the vehicle owner.
12. [Signs](#) on public property placed by the City.
13. Routine maintenance (the cleaning, painting, and minor repair of a sign in a manner that does not alter the size, basic copy, design, or structure of the sign).
14. Directional signs owned and placed by the City or Colorado Department of Transportation.
15. Private directional signs approved by City Administrator or delegee.

### B. Temporary Signs on Public Property.

All [temporary signs](#) located on public property, including traffic medians, along roads, and sidewalks are

allowed subject to the following conditions:

1. Signs must be under six (6) square feet and may only be displayed for up to three (3) days with the exception of signs placed in public parks by the City Administrator or delegee.
2. Signs must clearly indicate the date of their posting and are subject to removal without notice after their time limit has lapsed or if the sign fails to indicate the date of their posting.
3. Signs are not permitted to be placed on property containing government buildings or in public parks unless authorized by City Administrator or delegee. Nothing prohibits government from placing signs on its property.

**C. Signs Requiring Permits**

All [signs](#) not listed in Section 8-3-A or B and not prohibited by Section 8-5 require a permit. Permits shall issue only for signs in compliance with all Performance Criteria in Section 8-4. No sign requiring a permit shall be allowed in the R-1 Zoning District. Applications for a sign permit shall be submitted to the City on forms supplied by the City and accompanied by an application fee as set by City Council.

## Section 8-4 Performance Criteria

A. All signs in the City of Ouray shall meet the requirements of this section. Signs not in compliance with the criteria may be removed or confiscated without notice.

### B. Requirements

1. All [signs](#) shall be maintained in good, legible, and safe condition and in accordance with applicable requirements or laws. Signs in disrepair due to lack of maintenance and upkeep or that are illegible will be considered a nuisance and abated in accordance with City regulations. A building permit is required for any structural work associated with a sign.
2. No part of any sign attached to or within six feet of a building shall be higher than the line of the roof or parapet of the building.
3. No part of any sign shall be higher than twenty (20) feet above grade.
4. No sign may be erected or maintained which creates a public or private nuisance, or which unreasonably interferes with the reasonable enjoyment of the adjacent property by reason of unreasonable light, shade, or other effects.
5. Any building or combination of businesses in a building are allowed a [total sign face area](#) not to exceed the lesser of one square foot per foot of street frontage of the premises or one hundred fifty (150) square feet. For purposes of this Section, street frontage is defined as the length of the building that abuts the right of way. Exceeding the maximum allotted for total sign face area in this Section is permitted only in the following circumstances:
  - a. Businesses with less than 20 feet of street frontage shall be allowed 20 square feet of sign face area.
  - b. Buildings with a combination of businesses meeting the criteria of Section 8-4-B-5-a.
6. Buildings with frontages on two sides of a corner lot may display signage on both frontages subject to the following limitations:
  - a. Sign face area on any frontage may not exceed one square foot per foot of frontage on that side.
7. The maximum sign face area allowed for any individual sign is seventy-five (75) square feet.
8. Signs may have no more than two (2) sign faces.
9. Signs may be erected only upon property or be extended onto property which the sign owner has a legal right to erect or extend such sign.
10. Signs must be removed from a vacated premises within 7 days of the last day of operations.
11. The following rules and standards shall apply in establishing the type of illumination, which may be used for signs:

- a. Indirect lighting of all types of signs is permitted.
  - b. The light from any illuminated sign shall be shaded, shielded, or directed so that the light intensity or brightness will not be disruptive to residential property or adjacent property or create a distraction to a motorist.
  - c. No sign shall have or contain blinking, flashing, fluttering or intermittent lights or other devices, which create a change in color, brightness, direction, or intensity of lighting.
  - d. Colored lights shall not be used at any location or in any manner, except exposed neon tubing as described in this chapter.
  - e. The intensity of sign lighting shall not exceed that necessary to illuminate and make legible a sign from the adjacent travel way or closest municipal Street.
12. Signs with exposed neon tubing attached to the inside of a window may only be illuminated during business hours. "Closed" signs may be illuminated after business hours.
13. Signs must identify the use or establishment upon which they are located.
14. Any business may install canvas or fabric awnings and have its business name lettered once on any awning, or combination of awnings, in letters, not more than one foot high, following review and approval by the City.

#### AWNING SIGN

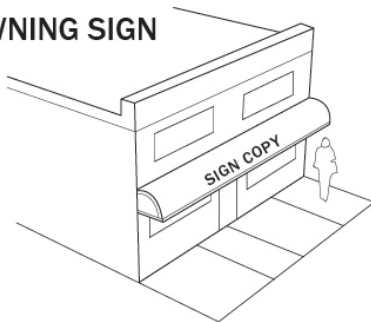

15. [Window signs](#) shall not occupy more than 50% of the area of subject window.
16. City may approve real estate development identification signs, used during construction or as permanent identification, to be erected and maintained subject to the following:

#### DEVELOPMENT SIGN

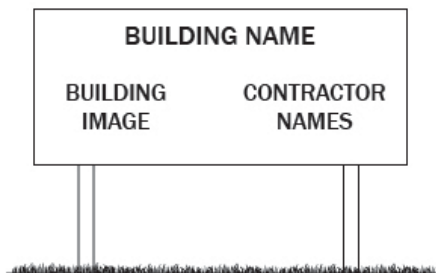

- a. No such sign shall exceed thirty-two (32) square feet in sign face area.
- b. Only one (1) such sign shall be permitted per development project.

17. [Banners](#) attached to the exterior of a building shall only be displayed for a maximum of 120 days per calendar year. No single banner shall exceed 20 square feet in total size. No more than 1 banner shall be displayed on any business front at any one time. Once a permit has been obtained for a banner, the permittee is not required to obtain a new permit for consecutive calendar years, provided that the banner and display times remain as originally permitted. Banners in compliance with these provisions shall not count towards total sign face area.

### BANNER SIGN

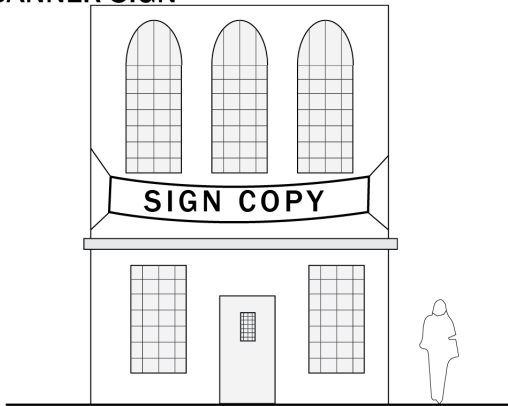

18. Signs may be erected over or upon City-owned streets and alley rights-of-way subject to the following conditions and in addition to other applicable requirements:

### RIGHT-OF-WAY SIGN

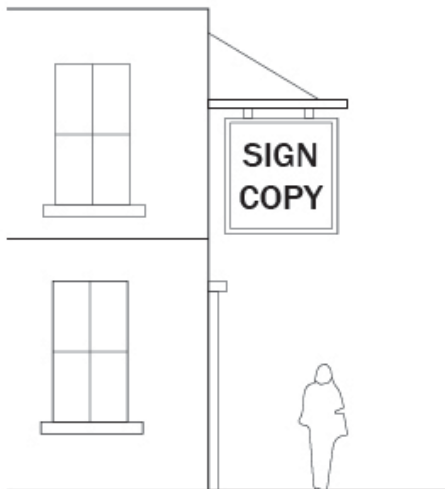

- a. Any sign must be supported and attached to a building located in the R-2, C-1, or C-2 Zoning Districts.
- b. The sign may extend a maximum of five (5) feet from the building and no portion of a sign may be located within six (6) feet to the curb.

- c. No part of the sign may be less than ten (10) feet above the ground over City right-of-way unless special approval is received from the City.
  - d. Only one (1) sign per business may extend over the City right-of-way.
  - e. No sign face that is parallel to the wall of the building to which it is attached, may extend more than twelve inches from the building.
  - f. [Banners](#) hung over public property or right-of-way that promote an event or activity of public benefit may be allowed. These banners shall conform to Colorado Department of Transportation Regulations.
19. [A-frame signs](#) in commercial and industrial zones may be erected on public sidewalks without counting against any maximum sign face area allotment, provided:
- a. No A-frame sign may exceed six (6) square feet for each sign face.
  - b. Only one A-frame sign is allowed per business on each sidewalk that it abuts.
  - c. Each A-frame sign may be displayed only during that establishment's hours of operation.
  - d. A minimum of three (3) consecutive feet of unobstructed area for use by pedestrians is allowed.

## Section 8-5 Prohibited Signs

- A. The following are hereby prohibited if visible from off the premises upon which they are located:
1. Animated, rotating, moving, or flashing signs, not including official traffic control devices.
  2. [Banners](#), balloons, or wind-powered devices designed to attract attention, other than [flags](#) allowed pursuant to Section 8-3-A-9, or banners expressly permitted by this Chapter.
  3. The operation of search lights to promote business activities.
  4. Billboards and [off-premises signs](#), except as otherwise expressly permitted by this Chapter.
  5. Signs on the exterior of buildings with exposed neon tubing, except vacancy/no vacancy signs and open/closed signs.
  6. Signs which create traffic or safety hazards, are structurally unsafe, unsafely installed, or otherwise hazardous.
  7. Any sign not maintained in good condition with good condition defined as a neatly kept and painted sign, including all surfaces such as metal and supports, having no broken, cracked, torn, stained, or faded materials, having no hazards through instability, unsecured elements, or other unsafe condition, and having functional lighting, where permitted.
  8. Any signs with obscenities, as defined under federal law.
  9. Any sign nailed, fastened, or affixed to any tree.
  10. Any sign that blocks a driver's clear line of sight of traffic or pedestrians.
  11. Any sign that obstructs free ingress to or egress from a fire escape, door, window, or other required access way to or from a building or site.
  12. Signs which unreasonably or unnecessarily illuminate or block the light, air, or view of neighboring properties.
  13. Any sign that interferes with the view of, or is confused with, any traffic control sign or device, and any sign that misleads or confuses traffic flow. A sign's position, size, shape, color, and illumination, but not its content, shall be considered when making such a determination.

### **Section 8-6 Nonconforming Signs**

A. Signs which were lawfully erected and maintained in accordance with previously applicable City or State regulations which do not comply with the regulations of this Chapter are considered nonconforming signs.

B. The right to maintain a nonconforming sign, including frames and supports, shall be terminated and the sign removed under the following conditions:

1. Failure to maintain the sign, abandonment, or termination of the related business, or the use of which the sign content has been discontinued for eight (8) months.
2. The destruction of the sign, removal of the sign, or damage to the sign, such that the cost of replacement or repair is greater than 50 percent of the replacement cost of the nonconforming sign.
3. The creation of any additional violation or nonconformity with this Chapter.

### **Section 8-7 Sign Enforcement**

A. It shall be unlawful to erect or maintain any sign except in compliance with the requirements of this Chapter.

1. Signs not in compliance with the provisions of this Chapter are hereby declared to be a nuisance and may be abated by the City in any lawful manner.
2. Any sign permit may be revoked for violation of this Chapter.
3. Any sign on City property without a permit is in violation of this Chapter and may be confiscated by the City without notice.
4. If upon inspection by City Administrator or delegee determines that a sign violates this Chapter, the inspector should give notice to the sign owner specifically stating the nature of the violation and requiring them to repair, remove, or modify the sign within seven (7) days after receipt of notice by email, regular mail, or posting on the property.
5. In cases of emergency, where a sign presents an imminent hazard to public safety, the sign inspector may cause the immediate removal of a dangerous defective sign, at the owner's expense.
6. All such costs, assessments, penalties and any other costs of collecting assessments or amounts due to enforce this Chapter, including attorney fees, court costs, any other out-of-pocket costs to abate the nuisance shall be a lien against the abutting property which may be foreclosed by the City in any lawful manner. Such costs may be certified to the county for collection with real property taxes or may be collected in any other lawful manner. Prior thereto, the City shall notify the owner of record of the property and allow a hearing with a City representative concerning any amount proposed to be certified to the County for collection.

#### A. Adult Entertainment Business Conditional Use Permit

1. Shall be no closer than 1,000 feet to any similar use and no closer than 1,000 feet to a residential district or use, religious use, educational use, or recreational use.
2. Shall be screened along adjoining property lines to prevent any direct visual contact of the adult business from the perimeter.
3. Any preview areas prior to entering the business premises are prohibited.
4. Measurements shall be made in a straight line, without regard to intervening structures or objects, from the main entrance of such adult business to the closest point on the property line of such other adult business, residential district or use, religious use, educational use, or recreational use.
5. No adult business shall be open for business between the hours of \_\_\_\_\_ and \_\_\_\_\_ a.m. (\_:00 a.m.).
6. The proposed location, design, construction, and operation of the particular use shall provide adequate safeguards to protect the health, safety, and general welfare of persons residing or working in adjoining or surrounding property.
7. No part of the interior of the adult business shall be visible from the pedestrian sidewalk, walkway, street, or other public or semi-public area.
8. Such use shall not impair an adequate supply of light and air to surrounding property. g. Such use shall not unduly increase congestion in the streets or public dangers, including fire and safety hazards. h. Such use shall not diminish or impair established property values in adjoining or surrounding property.
9. Applications for adult entertainment businesses shall be accompanied by evidence concerning the feasibility of the proposed request and its effect on surrounding property. The application shall also include a site plan defining the areas to be developed for buildings and structures, the areas to be developed for parking, driveways and points of ingress and egress, the location and height of walls, the location and type of landscaping, and the location, size and number of signs.
10. An adult business shall post a sign at the entrance of the premises that shall state the nature of the business and shall state that no one under the age of 18 years of age is allowed on the premises. This Section shall not be construed to prohibit the owner from establishing an older age limitation for admission to the premises.

#### B. Prohibited Activities of Adult Entertainment Businesses

1. No adult entertainment business shall employ any person under 18 years of age.
2. No adult entertainment business shall furnish any merchandise or services to any person who is under 18 years of age
3. It is unlawful to operate an adult entertainment business in any manner so as to be seen from any public way or within any property not licensed for such use. No operator of an adult entertainment business or any officer, associate, member, representative, agent, owner, or

employee of such business shall engage in any activity or conduct in or about the premises which is prohibited herein or any other laws of the State.

P.O. Box 468  
320 Sixth Avenue  
Ouray, Colorado 81427



970.325.7211  
Fax 970.325.7212  
www.cityofouray.com

---

## **MEMORANDUM**

**TO:** City of Ouray City Council & Planning Commission  
**FROM:** Lily Oswald, AICP (“Staff”)  
**DATE:** January 23, 2023  
**SUBJECT:** Land Use and Development Code / Sign Code Updated Draft - Joint Work Session

The updated Land Use and Development Code and Sign Code were updated for the Planning Commission’s consideration during the Special Meeting scheduled on December 20, 2022.

There are a few items which have to be considered by the City Council during upcoming meetings regarding the Land Use and Development Code. Apart from any general changes and discussions on the chapters, the outstanding items needed for discussion and legal review include:

1. Adopting the City’s Street Numbering provisions as a separate policy.
2. Completing the definition for “Sexually-Oriented Business” (pg. 14).
3. Drafting a Road & Bridge Impact Section (“Reserved” in Section 7-9-D-1).

The Planning Commission recommended approval of the two chapters to the City Council with the following condition: *Completion of the above listed outstanding items from the City Attorney and City Staff.*

The Planning Commission and City Council should consider long-term effects of the land use code and sign code and the how those changes will affect the community, development, density, land use, and processes. Changes of significance to these drafts are outlined below and are meant to guide the joint work session:

### **LAND USE & DEVELOPMENT CODE:**

- 1. Reorganized sections and subsections**
  - a. Review Table of Contents
- 2. Definitions | pg. 8 – 16**
  - a. Affordable Housing (pg. 8)
  - b. Attainable Housing (pg. 8)
  - c. Extended Stay Hotel (pg. 9)
  - d. Kitchen (pg. 10)
  - e. Lodging Unit (pg.10)
  - f. Mixed Use (pg. 12)
  - g. Mobile Home (pg. 12)
  - h. Modular Home (pg. 12)
  - i. Parking Space (pg. 13)
  - j. Short Term Rental (pg. 14)
  - k. Subterranean (pg. 16)

1. Workforce Housing (pg. 16)
3. **Posting Notices and Requirements** | pg. 20 – 22
4. **Overlay Districts** | pg. 46
5. **Table of Dimensional Requirements** | pg. 64
6. **Maximum Building Height Extension** | pg. 68
7. **Setback Exceptions Allowed** | pg. 67 – 68
8. **Parking Requirements** | pg. 69 – 72
9. **Affordable Housing vs. Attainable Housing vs. Workforce Housing**
  - a. Fee Reductions or Waivers (pg. 7)
  - b. Density Bonuses (pg. 63)
  - c. Parking reductions (pg. 70)
10. **Parks, Trails, Open Space Dedication Requirements**
  - a. Decreased fee per lot/unit (pg. 81)
11. **RV occupancy when home/site is under construction** | pg. 56
12. **Names and processes of different subdivisions** | pg. 17
  - a. Subdivision (pg. 34)
  - b. Lot Split (pg. 38)
  - c. Replat/Boundary Adjustments/Lot Consolidation (pg. 39)
  - d. Minor Subdivision (pg. 40)
  - e. Amended Plat (pg. 40)
  - f. Planned Unit Developments – Major (pg. 41)
  - g. Planned Unit Developments – Minor (pg. 42)
  - h. Condominiumization (pg. 43)

**SIGN CODE:**

1. **Purpose Statements** | pg. 2
  - a. Condensed and clarified.
2. **Definitions** | pg. 3 – 4
  - a. Additions & Revisions
  - b. Awning definition (to existing definition, or new?)
3. **Signs Allowed without a Permit** | pg. 5
  - a. General provisions
  - b. (B) Temporary Signs on Public Property
4. **Prohibited Signs** | pg. 11
  - a. Additions & Revisions
5. **Sign Enforcement** | pg. 13
  - a. New Section

**RESOLUTION NO. 3 (SERIES 2023)**

**A RESOLUTION OF THE CITY COUNCIL OF THE CITY OF OURAY, COLORADO ADOPTING A MASTER FEE SCHEDULE FOR LAND USE APPLICATIONS AND OTHER REVIEW PROCESSES UNDER OURAY MUNICIPAL CODE SECTION 7-3-B-1, SIGN PERMITS UNDER SECTION 8-3-B, BUILDING PERMITS AND INSPECTION FEES UNDER SECTION 6-1-C-1-b, FIXED ENCROACHMENT PERMITS UNDER SECTION 13-3-G-1-b, AND TEMPORARY ENCROACHMENT PERMITS UNDER SECTION 13-3-H-4-c; AND INCREASING THESE FEES EFFECTIVE IMMEDIATELY.**

**WHEREAS**, City Council is authorized to set fees under the Ouray Municipal Code (OMC), Section 7-3-B-1.

**WHEREAS**, Staff conducted a lengthy review of the fees charged for land use applications and requests under OMC 7-3-B-1, sign permits under OMC 8-3-B, building permits and inspections of those permits under OMC 6-1-C-1-b, fixed encroachment permits under 13-3-g-1-b, and temporary encroachment permits under 13-3-H-4-c by reviewing the average costs of all expenses, including staff time, associated with the administration of the applicable provisions of the OMC over the past two years.

**WHEREAS**, staff discovered that the fees charged by the City are inadequate for the services delivered and that fees have not been consistently reviewed and revised through the years.

**WHEREAS**, City Council reviewed the proposed fee schedule at its regularly scheduled City Council meeting on February 21, 2023, providing adequate notice and an opportunity to be heard.

**WHEREAS**, the City Council finds that the methods used to review and revise the fee schedule were appropriate and the proposed fees are fair and equitable.

**WHEREAS**, City Council further finds that the fee schedule concerning building permit and inspection fees under OMC 6-1-C-1-b t have not been raised since the IBC was adopted in 2012 and that these fees, along with the others contained in the proposed fee schedule are extremely low and should be implemented immediately for the health, safety, and welfare of the public.

**NOW, THEREFORE, BE IT RESOLVED BY THE CITY COUNCIL OF THE CITY OF OURAY, COLORADO** as follows:

1. The fee structure attached as Exhibit A is fair and equitable and is hereby adopted and is effective immediately.
2. Staff are directed to place the new fee structure on the City website.

ADOPTED this 21st day of February 2023 by the Ouray City Council.

CITY OF OURAY, COLORADO

---

Ethan Funk, Mayor

ATTEST:

---

Melissa M. Drake, City Clerk

## EXHIBIT A

COMMUNITY DEVELOPMENT: LAND USE FEES		
Item	Description	Fee
1	<b>Site Development Permit</b> - Single Family & Duplex Dwelling Unit	\$400.00
2	<b>Site Development Permit</b> - Multi-Family Dwelling Units	\$500.00 + \$50.00 per dwelling unit/lot
3	<b>Site Development Permit</b> - Commercial	\$750.00
4	<b>Site Development Permit</b> - Accessory Dwelling Unit (ADU)	\$500.00
5	<b>Site Development Permit</b> - Other	\$500.00
6	<b>Conditional Use Permit</b> - New	\$750.00
7	<b>Conditional Use Permit</b> - Extension	\$400.00
8	<b>Variance Application</b> - New	\$750.00
9	<b>Variance Application</b> - Extension	\$500.00
10	<b>Rezoning</b> Application	\$750.00
11	<b>Subdivision</b> - Sketch Plan Application	\$500.00
12	<b>Subdivision</b> - Preliminary Plat Application	\$800.00
13	<b>Subdivision</b> - Final Plat Application	\$400.00
14	<b>Lot Split</b> Application	\$500.00
15	<b>Replat</b> Application	\$500.00
16	<b>Amended Plat</b> Application	\$500.00
17	<b>Minor Subdivision</b> Application	\$500.00
18	<b>Planned Unit Development (PUD)</b> - Sketch Plan Application	\$500.00
19	<b>Planned Unit Development (PUD)</b> - Preliminary Plat Application	\$800.00
20	<b>Planned Unit Development (PUD)</b> - Final Plat Application	\$400.00
21	<b>Condominiumization Application</b> - Minor	\$500.00
22	<b>Condominiumization Application</b> - Sketch Plan Application	\$500.00
23	<b>Condominiumization Application</b> - Preliminary Plat Application	\$800.00
24	<b>Condominiumization Application</b> - Final Plat Application	\$400.00
25	<b>Mobile Home/RV Park</b> Application	\$750.00
26	<b>Sign Permit</b> Application - Mounted Sign	\$100.00
27	<b>Sign Permit</b> Application - Free-Standing Sign	\$50.00
28	<b>Sign Permit</b> Application - 120-day Banner	\$50.00
29	<b>Sign Permit</b> Application - Temporary Event Banner <i>(Fee waived for nonprofits)</i>	\$25.00

30	<b>Temporary Encroachment</b> Application - Outdoor Display of Merchandise	\$50.00 + \$150.00/12 days per year
31	<b>Temporary Encroachment</b> Application - Temporary Construction Storage	\$50.00
32	<b>Temporary Encroachment</b> Application - Other	\$50.00
33	<b>ROW Temporary License</b> (Food & Liquor) Application - 30 days>	\$50.00
34	<b>ROW Temporary License</b> (Food & Liquor) Application - May to Nov.	\$150.00
35	<b>Fixed Encroachment</b> Application	\$250 + Sq.Ft. Encroachment Area Assessed Value of Land (excl. Improvements)
36	<b>Short-Term Rental License</b> - New Application	\$750.00
37	<b>Short-Term Rental License</b> - Annual Renewal Application	\$500.00
38	<b>Parks Fee-in-Lieu</b> (Subdivision) (Per new unit/lot)	\$450.00
39	<b>RV Work Force Housing</b> Permit	\$50 + \$25/week
40	<b>Zoning Verification</b> Letter	\$75.00

**COMMUNITY DEVELOPMENT: BUILDING FEES**

<b>Item</b>	<b>Description</b>	<b>Fee</b>
1	<b>Temporary Certificate of Occupancy</b>	\$0.00
2	<b>Certificate of Occupancy</b>	\$0.00
3	<b>Temporary Structure</b> Application	\$50.00
4	<b>Demolition Permit</b> Application	\$0
5	<b>Intermodal Shipping Container</b> Permit	\$750 Deposit
6	<b>Floodplain Development</b> Permit Application	\$150.00
7	<b>Burn Permit</b> Application	\$25.00
8	<b>EQR/Property Declaration</b> Inspection	\$65.00 per hour
9	<b>Mechanical Permit</b> Application	<i>See Valuation Table</i>
10	<b>Building Permit</b> Application	<i>See Valuation Table</i>
11	<b>Re-Roof Permit</b> Application	<i>See Valuation Table</i>
12	<b>Inspection outside of normal business hours</b> <i>(two hours minimum charge)</i>	\$65.00/hour = \$130.00
13	<b>Re-inspection fees</b> assessed under provisions of IBC	\$65.00 per hour
14	<b>Inspections for which no fee is specifically indicated</b> <i>(one hour minimum charge)</i>	\$65.00 per hour
15	<b>Additional plan review</b> required by revisions to plans <i>(one hour minimum charge)</i>	\$65.00 per hour
16	<b>Outside Consultant Use</b> for plan review, inspections, or both <i>(incl. administration and overhead costs)</i>	Actual Costs
17	<b>Plan Review Fee</b> (incl. Building Permits, Mechanical Permits)	65% of Permit Fee

**Valuation Table**

1	\$1.00 to \$500.00	\$51.50
2	\$501.00 to \$2,000.00	\$51.50 for first \$500, plus \$3.35 for each additional \$100 or fraction thereof, to and including \$2,000
3	\$2,001.00 to \$25,000.00	\$101.75 for the first \$2,000; plus \$16.25 for each additional \$1,000 or fraction thereof, to and including \$25,000
4	\$25,001.00 to \$50,000.00	\$475.50 for the first \$25,000; plus \$11.75 for each additional \$1,000 or fraction thereof, to and including \$50,000
5	\$50,001.00 to \$100,000.00	\$769.25 for the first \$50,000; plus \$8.10 for each additional \$1,000 or fraction thereof, to and including \$100,000
6	\$100,001.00 to \$500,000.00	\$1,174.25 for the first \$100,000; plus \$6.50 for each additional \$1,000 or fraction thereof, to and including \$500,000
7	\$500,001.00 to \$1,000,000.00	\$3,774.25 for the first \$500,000; plus \$5.60 for each additional \$1,000 or fraction thereof, to and including \$1,000,000
8	\$1,000,001.00 and up	\$6,574.25 for the first \$1,000,000; plus \$4.20 for each additional \$1,000 or fraction thereof

**COMMUNITY DEVELOPMENT: LAND USE FEES**

<b>Item</b>	<b>Description</b>	<b>Existing Fee</b>	<b>Updated Fee</b>
1	<b>Site Development Permit</b> - Single Family & Duplex Dwelling Unit	\$200.00	\$400.00
2	<b>Site Development Permit</b> - Multi-Family Dwelling Units	\$200.00	\$500.00 + \$50.00 per dwelling unit/lot
3	<b>Site Development Permit</b> - Commercial	\$200.00	\$750.00
4	<b>Site Development Permit</b> - Accessory Dwelling Unit (ADU)	\$200.00	\$500.00
5	<b>Site Development Permit</b> - Other	\$200.00	\$500.00
6	<b>Conditional Use Permit</b> - New	\$200.00	\$750.00
7	<b>Conditional Use Permit</b> - Extension	\$200.00	\$400.00
8	<b>Variance Application</b> - New	\$500.00	\$750.00
9	<b>Variance Application</b> - Extension	\$500.00	\$500.00
10	<b>Rezoning</b> Application	\$200.00	\$750.00
11	<b>Subdivision</b> - Sketch Plan Application	\$200.00	\$500.00
12	<b>Subdivision</b> - Preliminary Plat Application	\$400.00	\$800.00
13	<b>Subdivision</b> - Final Plat Application	\$300.00	\$400.00
14	<b>Lot Split</b> Application	\$300.00	\$500.00
15	<b>Replat</b> Application	\$300.00	\$500.00
16	<b>Amended Plat</b> Application	\$300.00	\$500.00
17	<b>Minor Subdivision</b> Application	\$250.00	\$500.00
18	<b>Planned Unit Development (PUD)</b> - Sketch Plan Application	\$200.00	\$500.00
19	<b>Planned Unit Development (PUD)</b> - Preliminary Plat Application	\$400.00	\$800.00
20	<b>Planned Unit Development (PUD)</b> - Final Plat Application	\$300.00	\$400.00
21	<b>Condominiumization Application</b> - Minor	\$250.00	\$500.00
22	<b>Condominiumization Application</b> - Sketch Plan Application	\$200.00	\$500.00
23	<b>Condominiumization Application</b> - Preliminary Plat Application	\$400.00	\$800.00
24	<b>Condominiumization Application</b> - Final Plat Application	\$300.00	\$400.00
25	<b>Mobile Home/RV Park</b> Application	\$300.00	\$750.00
26	<b>Sign Permit</b> Application - Mounted Sign	\$25.00	\$100.00
27	<b>Sign Permit</b> Application - Free-Standing Sign	\$25.00	\$50.00
28	<b>Sign Permit</b> Application - 120-day Banner	\$25.00	\$50.00
29	<b>Sign Permit</b> Application - Temporary Event Banner <i>(Fee waived for nonprofits)</i>	\$25.00	\$25.00





<b>Total Valuation - EXISTING</b>		
18	\$1.00 to \$500.00	\$24.00
19	\$501.00 to \$2,000.00	\$24 for first \$500, plus \$3 for each additional \$100 or fraction thereof, to and including \$2,000
20	\$2,001.00 to \$40,000.00	\$69 for the first \$2,000; plus \$11 for each additional \$1,000 or fraction thereof, to and including \$40,000
21	\$40,001.00 to \$100,000.00	\$487 for the first \$40,000; plus \$9 for each additional \$1,000 or fraction thereof, to and including \$100,000
22	\$100,001.00 to \$500,000.00	\$1,027 for the first \$100,000; plus \$7 for each additional \$1,000 or fraction thereof, to and including \$500,000
23	\$500,001.00 to \$1,000,000.00	\$3,827 for the first \$500,000; plus \$5 for each additional \$1,000 or fraction thereof, to and including \$1,000,000
24	\$1,000,001.00 to \$5,000,000	\$6,327 for the first \$1,000,000; plus \$3 for each additional \$1,000 or fraction thereof, to and including \$5,000,000
25	\$5,000,001 and over	\$18,327 for the first \$5,000,000; plus \$1 for each additional \$1,000 or fraction thereof
<b>Total Valuation - UPDATED</b>		
26	\$1.00 to \$500.00	\$51.50
27	\$501.00 to \$2,000.00	\$51.50 for first \$500, plus \$3.35 for each additional \$100 or fraction thereof, to and including \$2,000
28	\$2,001.00 to \$25,000.00	\$101.75 for the first \$2,000; plus \$16.25 for each additional \$1,000 or fraction thereof, to and including \$25,000
29	\$25,001.00 to \$50,000.00	\$475.50 for the first \$25,000; plus \$11.75 for each additional \$1,000 or fraction thereof, to and including \$50,000
30	\$50,001.00 to \$100,000.00	\$769.25 for the first \$50,000; plus \$8.10 for each additional \$1,000 or fraction thereof, to and including \$100,000
31	\$100,001.00 to \$500,000.00	\$1,174.25 for the first \$100,000; plus \$6.50 for each additional \$1,000 or fraction thereof, to and including \$500,000
32	\$500,001.00 to \$1,000,000.00	\$3,774.25 for the first \$500,000; plus \$5.60 for each additional \$1,000 or fraction thereof, to and including \$1,000,000
33	\$1,000,001.00 and up	\$6,574.25 for the first \$1,000,000; plus \$4.20 for each additional \$1,000 or fraction thereof