

No. _____



UNITED INDEPENDENT SCHOOL DISTRICT AGENDA ACTION ITEM

TOPIC Approval of Request from Mr. William B. Johnson for \$7,062.96 and Mr. Juan Roberto Ramirez for \$2,842.18 for the Use of Board of Trustees Discretionary Funds for Nye Elementary School.

SUBMITTED BY: William Johnson & Juan Roberto Ramriez **OF:** Board Members

APPROVED FOR TRANSMITTAL TO SCHOOL BOARD: _____

DATE ASSIGNED FOR BOARD CONSIDERATION: December 17, 2008

RECOMMENDATION:

RATIONALE:

BUDGETARY INFORMATION

BOARD POLICY REFERENCE AND COMPLIANCE:



Exhibit A

United Independent School District
Board of Trustees Discretionary Funds Request Form
Fiscal Year 2008-2009

Requesting Campus: Nye Elementary School

Campus Principal: Patricia E. Lañas

Board Member: William B. Johnson

Board Member: _____

Description of Request: • Beginning Literacy "Sing and Read"
and nursery rhyme Collection - Pre K Series.
• AR book and quizzes for library
• Ice Maker for faculty, staff, and students.

Estimated Cost of Request 7,062.96

Principal Signature: Patricia E. Lañas Date 12-3-08

Board Member Approval: Yes No

Board Member Signature: _____ Date _____

Board Member Signature: _____ Date _____

Superintendent Signature: _____ Date _____

Board Approval: Yes No Date Approved: _____

Please return the completed form to the Superintendent's Office for final processing.

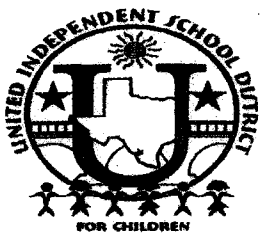

UNITED INDEPENDENT SCHOOL DISTRICT

Purchase Requisition

Page ____ to ____

Vendor Name and Address

Compact Appliance
 8606 Wall Street Suite 1800
 Austin Tx 78754
 Phone No: 1800 297 6076
 Campus: Nye Elem. Rm NO: _____
 Date: _____

FUND/YR	FUNC.	ORG.	PROGRAM	LOCAL	PROJECT	SUB	OBJECT	OBJECT	AMOUNT
			CODE	OPTION	NUMBER	OBJECT	OBJECT		

BUDGET CODE

ACCOUNT CODE

QTY	ITEM #	DESCRIPTION	UNITED PRICE WITH DISCOUNT	EXTENSION
1	1B45055	Stainless Full size Ice Maker	879.00	879.00
		Shipping	-0-	-0-
		Free holiday shipping		

DISPOSITION: Pick-up Mail Check FAX # _____ PAGE TOTAL 879.00

REMARK: _____ GRAND TOTAL 7.0

ORIGINATOR (PRINT)	DATE	BUDGET COORDINATOR	DATE
ADMINISTRATOR SIGNATURE	DATE	OTHER	DATE

* Most Reasonable - Quote I

ICE MAKERS

FREE SHIPPING ON SELECT ICE MAKERS

STAINLESS FULL SIZE ICE MAKER

Undercounter Clear Ice Maker - Stainless Steel

EdgeStar's newest ice maker produces up to 45 lbs. of restaurant quality ice cubes per day. Complete with a reversible, commercial grade stainless steel wrapped door, it is the ideal companion to virtually any stainless refrigerator or beverage center. At a height of 32.8", this counterhigh ice machine also features a versatile front venting design, allowing for both free standing or built in use.

- Up to 45 lbs of ice production and 25 lbs of storage
- Door wrapped in commercial-grade stainless steel
- 45 lbs of production; 25 lbs of storage

(32 8/10" w x 14 6/10" h x 23 6/10" d)



FREE
HOLIDAY
SHIPPING

Model IB450SS

\$879.00

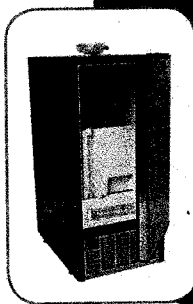

ICE MAKER WITH WATER DISPENSER

EdgeStar Ice Maker with Water Cooler/Heater/Dispenser

The EdgeStar IW400SS ice maker with water dispenser brings the convenience of a refreshing water dispenser and a filtered ice maker together into a single elegant and economical appliance. No more water lines or drains to worry about, just pure clean ice to complement our cool chilled water dispenser. The IW400SS also features hot and room temperature water dispensers for those warm drinks.

(40 2/10" h x 12 3/10" w x 14" d)



FREE
HOLIDAY
SHIPPING

Model IW400SS

\$399.00

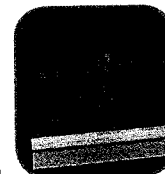
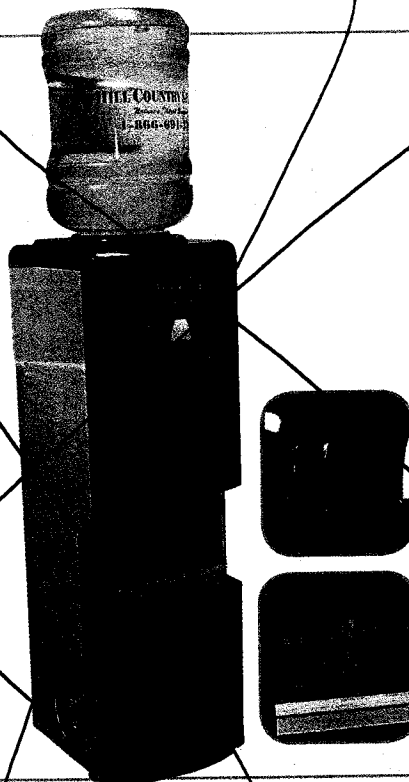

**DON'T SEE EXACTLY
WHAT YOU'RE
LOOKING FOR?**

Check out our wide selection of energy efficient appliances online at

WWW.COMPACTAPPLIANCE.COM

CA

COMPACT APPLIANCE

SMALL SOLUTIONS ~ SUPERIOR SERVICE

Call our Experts Today!

1-800-297-6076

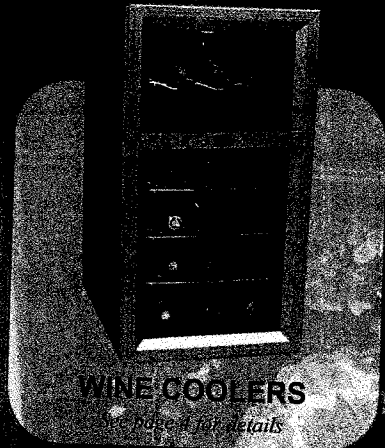

WINE COOLERS

See page 10 for details



ICE MAKERS

See page 10 for details



BEER AND BEVERAGE

See page 10 for details



F.Y.I.
BARBORA

LOOK INSIDE FOR FREE SHIPPING SPECIALS!



Quote #2

10/22/2008

To:
United ISD
Blanca Balboa

Project:
United ISD - Ice Machine

From:
Pasco Brokerage Inc
Amy Leasure
6465 Chase Oaks Blvd
Plano, TX 75023
Phone: (972) 596-3350

Pricing per the TASB Buy Board Contract #274-07.
Pricing includes standard dock delivery to your location.
QUOTE for teacher's lounge.

Item	Qty	Description	Sell Each	Sell Total
1	1	ea ICE MAKER WITH BIN, CUBE-STYLE Manitowoc Model No. QM-45A Packed: each Ice Maker w/Bin, cube-style, air-cooled, self-contained condenser, up to 95-lb approximately/24 hours, 30-lb. ice storage capacity, stainless steel finish, dice size cubes, 6" adjustable legs, 6' cord w/NEMA 5-15P plug	1,650.00	1,650.00
	1	ea 3 year parts & labor warranty		
	1	ea 5 year parts & labor warranty on evaporator		
	1	ea 5- year parts & 3- year labor warranty on compressor		
	1	ea 115v/60/1ph, std.		
	1	ea AR-PRE Arctic Pure® Pre-Filter Assembly, 5 micron filtration (NOT stand-alone; should be used in conjunction with primary water filter assembly)	110.00	110.00
			Merchandise	1,760.00
			Total	1,760.00

Acceptance: _____ Date: _____

Printed Name: _____

QM45 Series Ice Cube Machine



Manitowoc



QM45 Series

- Compact size. Produces up to 95 lbs. (43 kgs.) of ice every 24 hours with a storage capacity of 30 lbs. (14 kgs.) Ideal for any small-volume ice need
- CEE Tier 1 energy and water use rating
- Attractive stainless steel cabinet – euro-design
- Easy access door, slides up & out of the way
- Patented cleaning and sanitizing technology
- Easy access air filter
- Front air intake and exhaust
- CFC-FREE R-134A refrigerant
- Manitowoc proven vertical evaporator
- Computerized control
- 3-year parts-and-labor warranty

CEE  Energy Efficiency Ratings Specified on Back

America's #1 Selling Ice Machine

Ice Cube & Flake Machines • Ice Storage Bins • Ice Dispensers



Manitowoc QM45 Series

Model	Ice Shape	Ice production 24 hours		Power kWh/100 lbs. @90°/70°	CEE* Rating
		lbs.	kgs.		
QM45A	dice	65	30	14.9	Tier 1
Water usage/100 lbs./45.4 kgs. of ice					
Potable Water: 38.4 gallons, 146 liters					

*Following model number indicates Air cooled unit configuration.

*Consortium for Energy Efficiency (CEE) is a North American nonprofit organization that promotes energy-efficient products, technologies and services; also the principal entity for the development of ice maker efficiency standards.



Certified in Accordance with ARI Ice Storage Bins Certification Program, which is based on ARI Standard 820

Ice Machine Electric

115/60/1, (230/50/1 also available.) 115/60/1 ice machines are factory pre-wired with a 6' (180 cm) power cord and NEMA 5-15P-plug configuration.

Total Amps: 5.2 amps.

Maximum fuse size: 15 amps.

HACR-type circuit breakers can be used in place of fuses.

Specifications

BTU Per Hour:

1,750 (average) 2,600 (peak)

Compressor:

Nominal rating: 1/4 HP

Operating Limits:

- Ambient Temperature Range: 35° to 110°F (1.6° to 43°C)

- Water Temperature Range: 33° to 90°F (0.6° to 32°C)

- Water Pressure Ice Maker Water In: Min. 20 psi (138 kPa) Max. 80 psi (551 kPa)

Legs: Adjustable from 6.00"-7.25" (15.24-17.78 cm).

Ice Storage: One piece bin liner (seamless) "rotocast" polyethylene.

Insulation: Insulation foamed-in-place with CFC-FREE foam.



Air Flow Front View

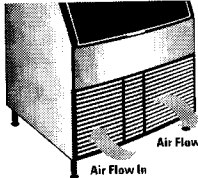

Air in left, air out right, no side vents.

Air Filter



Slides out from left side front without tools, easy to clean, reusable filter protects condenser from lint, grease and dust.

Cube Size



Dice
5/8" x 5/8" x 5/8"
(2.22 x 2.22 x 2.22 cm)

Front Access

Initiate ice, off and clean operations with simple upfront selector switch. No need to remove front panel.



24-HOUR PRODUCTION †			
AIR-COOLED UNIT			
air temp	water temp		
	°F	50°	70°
°C	10°	21°	32°
70°	95	80	70
21°	43	36	32
80°	90	75	65
27°	41	34	30
90°	80	65	55
32°	36	30	25

†Production for 100 lbs. (45.4 kgs.)

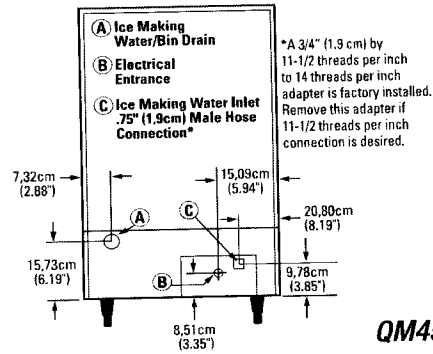
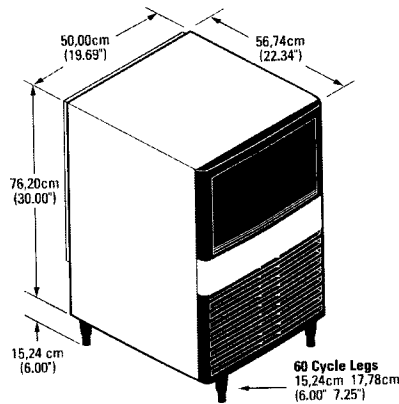

QM45

Installation Note - There is no minimum clearance required, however recommended clearance for top, sides, and back is 5" (12.7 cm).



Look for the EnergyMizer™ mark and you'll know you're getting the most from every energy dollar spent on foodservice equipment. www.energymizer.com



We are committed to protecting the environment and its resources. For up-to-date product data always view an electronic version on our web site.



MANITOWOC ICE, INC.
2110 South 26th Street, P.O. Box 1720
Manitowoc, WI 54221-1720, USA
Ph: 920-692-0151 • Fax: 920-693-7589
Visit us online at www.manitowocice.com



Arctic Pure®

Ice Machine - Water Filtration



Manitowoc



AR-10000

Over 60% of ice machine maintenance calls are water-related! Arctic Pure® water filters are designed exclusively for ice machine applications and will reduce these calls.

- Built-in scale inhibitor. Siliphos is designed into the filters to reduce scale build-up even under the hardest water conditions.
- Reduces chlorine taste and odor. All filtration and scale reduction material is NSF and/or FDA compliant and is engineered to reduce chlorine taste and odor. Ice looks and tastes better.
- Graded density carbon block filter. Provides superior dirt holding capacity and fine sediment reduction.
- Sanitary quick change housing. Design minimizes contamination of filter media during filter cartridge change-out. All filters are provided with automatic shut-off and pressure relief valves.

America's #1 Selling Ice Machine

Ice Cube & Flake Machines • Ice Storage Bins • Ice Dispensers



Manitowoc Arctic Pure.



AR-PRE
Pre-filter, dirt and rust sediment reduction



AR-10000
1 micron particle reduction
14,000 gal. capacity
20 grams silphos
Lbs. of ice per day 0-600

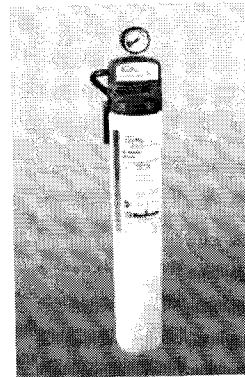

AR-20000
1 micron particle reduction
20,000 gal. capacity
40 grams silphos
Lbs. of ice per day 601-1000

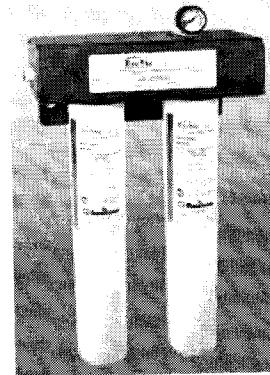

AR-40000
1 micron particle reduction
40,000 gal. capacity
80 grams silphos
Lbs. of ice per day 1001-2,500

Ice Machine	Model			
	AR-PRE	AR-10000	AR-20000	AR-40000
QM30	◆	◆		
QM45	◆	◆		
Q-130	◆	◆		
Q-210	◆	◆		
Q-270	◆	◆		
S-300	◆	◆		
S-322	◆	◆		
S-422	◆	◆		
S-450	◆	◆		
S-500	◆	◆		
S-600	◆	◆		
S-850	◆		◆	
S-1000	◆		◆	
S-1200	◆			◆
S-1400	◆			◆
S-1600	◆			◆
S-1800	◆			◆
Q-Dual	◆			
IB-600	◆	◆		
IB-800	◆		◆	
IB-1000	◆		◆	
QF-400	◆	◆		
QC-700	◆		◆	
QF-800	◆		◆	
QF-2300	◆			◆

Specifications

Maximum operating pressure:
25–125 psi (1.7–8.6 bar)

Maximum operating temperature:
35°–100°F (1.7°–38°C)

Flow Rate: AR-10000 0.75 gpm (2.84 LPM)
AR-20000 0.75 gpm (2.84 LPM)
AR-40000 1.5 gpm (5.68 LPM)

Cartridge Housing Material: Talc Filled Polypropylene

Primary Filter - 1 micron particle reduction. Filter media is graded density carbon block containing Silphos scale inhibitor, which holds dissolved minerals in suspension. (AR-10000/20 grams silphos, AR-20000/40 grams silphos, AR-40000/80 grams silphos – 40 grams per cartridge).

Inlet/Outlet fittings - 3/8" John Guest

Optional Pre-Filter – An optional pre-filter is recommended for ice machine installations in areas with high particulate matter (dirty water). The pre-filter extends the filtration efficiency and working life of the primary filter cartridge where this condition exists. The Manitowoc pre-filter is a cost-efficient solution to the particulate matter (dirty water) problem because pre-filter replacements are more economical than a primary filter cartridge.

Replacement Cartridges:

Pre-FilterK-00337
Primary Filter AR-10000K-00338
AR-20000/40000K-00339

To insure maximum filtration efficiency, replace the primary filter cartridge every 6 months. A filter gauge will indicate if replacement is necessary prior to six months usage (below 20 psig).

Important notice: Read this performance sheet and compare the capabilities of this unit with your actual water treatment needs. It is recommended that you have your water supply tested to determine your actual water treatment needs before purchasing a water treatment unit.

Warning: Do not use with water that is microbiologically unsafe or of unknown quality without adequate disinfections before or after the unit.

Caution: The filter must be protected from freezing. Failure to do so may result in cracking of the filter housing and water leakage.

Note: Before using the Arctic Pure on non-Manitowoc machines consult the ice machine manufacturer for water supply usage requirements.

Warranty: 3-Year parts and labor warranty on head, shroud, hardware, and mounting assembly (water filter cartridge not included).

Dimensions

Model	Dimensions						Mtg. Holes		Weight	
	Height		Width		Depth		Center to Center		lbs.	kgs.
	inches	cm	inches	cm	inches	cm	inches	cm		
AR-Pre	17.09	43.41	6.72	17.10	4.00	10.16	1.50	3.81	4	1.81
AR-10000	17.09	43.41	5.72	14.50	4.00	10.16	1.50	3.81	5	1.81
AR-20000	21.34	54.2	5.72	14.50	4.00	10.16	1.50	3.81	5	2.27
AR-40000	21.23	54.1	15.88	40	5.00	12.7	11.50 Top 9.75 Bottom	29.2	12	5.44



AR-PRE	Nominal particulate reductions Class IV.
AR-10000 AR-20000 AR-40000	Chlorine reduction taste and odor reduction Class I.

Visit www.nsf.org for listed product claims.



Manitowoc

MANITOWOC ICE, INC.
2110 South 26th Street, P.O. Box 1720
Manitowoc, WI 54221-1720, USA
Ph: 920-682-0161 • Fax: 920-683-7589
Visit us online at: www.manitowocice.com



Manitowoc Arctic Pure®



AR-PRE
Pre-filter, dirt and rust sediment reduction



AR-10000
1 micron particle reduction
14,000 gal. capacity
20 grams silphos
Lbs. of ice per day 0-600



AR-20000
1 micron particle reduction
20,000 gal. capacity
40 grams silphos
Lbs. of ice per day 601-1000



AR-40000
1 micron particle reduction
40,000 gal. capacity
80 grams silphos
Lbs. of ice per day 1001-2,500

Ice Machine	Model			
	AR-PRE	AR-10000	AR-20000	AR-40000
QM30	◆	◆		
QM45	◆	◆		
Q-130	◆	◆		
Q-210	◆	◆		
Q-270	◆	◆		
S-300	◆	◆		
S-322	◆	◆		
S-422	◆	◆		
S-450	◆	◆		
S-500	◆	◆		
S-600	◆	◆		
S-850	◆		◆	
S-1000	◆		◆	
S-1200	◆			◆
S-1400	◆			◆
S-1600	◆			◆
S-1800	◆			◆
Q-Dual	◆			
IB-600	◆	◆		
IB-800	◆		◆	
IB-1000	◆		◆	
QF-400	◆	◆		
QC-700	◆		◆	
QF-800	◆		◆	
QF-2300	◆			◆

Specifications

Maximum operating pressure:

25–125 psi (1.7–8.6 bar)

Maximum operating temperature:

35°–100°F (1.7°–38°C)

Flow Rate: AR-10000 0.75 gpm (2.84 LPM)

AR-20000 0.75 gpm (2.84 LPM)

AR-40000 1.5 gpm (5.68 LPM)

Cartridge Housing Material: Talc Filled Polypropylene

Primary Filter - 1 micron particle reduction. Filter media is graded density carbon block containing Silphos scale inhibitor, which holds dissolved minerals in suspension. (AR-10000/20 grams silphos, AR-20000/40 grams silphos, AR-40000/80 grams silphos – 40 grams per cartridge).

Inlet/Outlet fittings - 3/8" John Guss

Optional Pre-Filter – An optional pre-filter is recommended for ice machine installations in areas with high particulate matter (dirty water). The pre-filter extends the filtration efficiency and working life of the primary filter cartridge where this condition exists. The Manitowoc pre-filter is a cost-efficient solution to the particulate matter (dirty water) problem because pre-filter replacements are more economical than a primary filter cartridge.

Replacement Cartridges:

Pre-FilterK-00337

Primary Filter AR-10000K-00338

AR-20000/40000K-00339

To insure maximum filtration efficiency, replace the primary filter cartridge every 6 months. A filter gauge will indicate if replacement is necessary prior to six months usage (below 20 psig).

Important notice: Read this performance sheet and compare the capabilities of this unit with your actual water treatment needs. It is recommended that you have your water supply tested to determine your actual water treatment needs before purchasing a water treatment unit.

Warning: Do not use with water that is microbiologically unsafe or of unknown quality without adequate disinfections before or after the unit.

Caution: The filter must be protected from freezing. Failure to do so may result in cracking of the filter housing and water leakage.

Note: Before using the Arctic Pure on non-Manitowoc machines consult the ice machine manufacturer for water supply usage requirements.

Warranty: 3-Year parts and labor warranty on head, shroud, hardware, and mounting assembly (water filter cartridge not included).

Dimensions

Model	Dimensions						Mtg. Holes		Weight	
	Height		Width		Depth		Center to Center		lbs.	kgs.
	inches	cm	inches	cm	inches	cm	inches	cm		
AR-Pre	17.09	43.41	6.72	17.10	4.00	10.16	1.50	3.81	4	1.81
AR-10000	17.09	43.41	5.72	14.50	4.00	10.16	1.50	3.81	5	1.81
AR-20000	21.34	54.2	5.72	14.50	4.00	10.16	1.50	3.81	5	2.27
AR-40000	21.23	54.1	15.88	40	5.00	12.7	Top	29.2	12	5.44
							Bottom	9.75		



AR-PRE	Nominal particulate reductions Class IV.
AR-10000 AR-20000 AR-40000	Chlorine reduction taste and odor reduction Class I.

Visit www.nsf.org for listed product claims.

©2006 Manitowoc. NSF Certification product improvement may necessitate change of specifications without notice. 2189C



MANITOWOC ICE, INC.
2110 South 26th Street, P.O. Box 3720
Manitowoc, WI 54221-9720, USA
Ph: 920-682-0161 • Fax: 920-683-7568
Visit us online at www.manitowocice.com



Award Winning "Sing & Read" Beginning Literacy Series

Available in Spanish

Guaranteed Success with Beginning Literacy!



- Aligned with state standards
- Supports Reading First Initiative
- Enrich any curriculum with this series
- Perfect for the shared reading experience
- Sole Source

The Complete "Sing & Read" Collection

The Complete "Sing & Read" Collection

Includes all 5 Collections: Alphabet, Colors, Numbers, Shapes and Themes plus Master Storage Box

NES-1490 English Collection
NES-1491 Spanish Collection

\$920.99
\$999.99

- 65 (11" x 17" Big Books)
- 5 Teacher Guides on CD
- 5 CDs
- 5 Cross Curricular Guides
- 5 Storage Boxes

Highly recommended by educators for over 13 years, this award winning "Sing & Read" series introduces alphabet, color, counting, spelling and more! Colorful, friendly illustrations are sure to captivate young learners from the first page to the last! Children will develop an array of skills appropriate to individual levels, while young readers build confidence and a love for reading! Delightful stories that children love to hear again and again are available in large 11" x 17" format. Rhythmic and rhyme of familiar tunes make this award-winning series a necessity and will definitely put Reading First!

NOW AVAILABLE!
Nursery Rhyme Collection
NES-2180 \$145.99



National Educational Systems, Inc.





















6333 DeZavala Rd., Ste. 106

San Antonio, TX 78249



















Toll Free: 1.800.231.4380





















Fax: 210.699.4674





















PSRT BPM
U.S. POSTAGE
PAID
ITHACA, NY
PERMIT #59





















1	68039	Dark		Robert	E	1979	2.7	P-2	10.49	10.49
1	69383	Day It Snowed Tortillas = El Dia Que Nevaron Tortillas		Hayes, Joe	398	2003	4.5	5-9	15.76	15.76
1	71725	Deep Trouble		Stine, R. L.	F	1994	3.5	4-7	10.32	10.32
1	5624	Deep Trouble II		Stine, R. L.	F	1997	2.9	4-7	9.55	9.55
1	23867	Diego And Mami To The Rescue!		Romay, Alexis	E	2008	2.7	P-2	8.95	8.95
1	23861	Diego And Papi To The Rescue		Wax, Wendy	E	2007	3.1	P-2	8.95	8.95
1	27336	Diego And The Baby Sea Turtles		Rao, Lisa	E	2008	3.1	P-2	8.95	8.95
1	14462	Diego Saves A Butterfly		Bergen, Lara	E	2007	1.4	P-1	8.95	8.95
1	25265	Diego Saves The Sloth!		Romay, Alexis	E	2007	2.3	P-2	8.95	8.95
1	10747	Diego Saves The Tree Frogs		Willson, Sarah	E	2006	1.0	P-1	8.95	8.95
1	27337	Diego's Birthday Surprise		Bergen, Lara	E	2008	1.2	P-1	8.95	8.95
1	23869	Diego's Buzzing Bee Adventure		Inches, Alison	F	2008	1.6	P-1	8.76	8.76
1	10745	Diego's Wolf Pup Rescue		Ricci, Christine	E	2006	3.3	P-2	8.95	8.95
1	791	Don't Go To Sleep		Stine, R. L.	F	1997	2.7	4-7	9.55	9.55
1	12020	Doom With A View!		McKeever, Sean	741.5	2007	2.8	2-5	14.95	14.95
1	23865	Dora And The Stuck Truck		Beinstein, Phoebe	E	2008	2.4	P-2	8.95	8.95
1	14451	Dora Climbs Star Mountain		Inches, Alison	E	2007	2.0	P-2	8.95	8.95
1	7609	Dora Goes To School		Valdes, Leslie	E	2004	2.4	P-2	8.95	8.95
1	25266	Dora Had A Little Lamb		Risco, Elle D.	E	2007	2.0	P-2	8.95	8.95
1	7610	Dora Loves Boots		Inches, Alison	E	2004	2.1	P-2	8.95	8.95
1	7614	Dora's Christmas Parade		Valdes, Leslie	E	2003	2.2	P-2	10.52	10.52

Confirm Quote - Perma-Bound Books





















1	68039	Dark		Robert	E	1979	2.7	P-2	10.49	10.49
1	69383	Day It Snowed Tortillas = El Dia Que Nevaron Tortillas		Hayes, Joe	398	2003	4.5	5-9	15.76	15.76
1	71725	Deep Trouble		Stine, R. L.	F	1994	3.5	4-7	10.32	10.32
1	5624	Deep Trouble II		Stine, R. L.	F	1997	2.9	4-7	9.55	9.55
1	23867	Diego And Mami To The Rescue!		Romay, Alexis	E	2008	2.7	P-2	8.95	8.95
1	23861	Diego And Papi To The Rescue		Wax, Wendy	E	2007	3.1	P-2	8.95	8.95
1	27336	Diego And The Baby Sea Turtles		Rao, Lisa	E	2008	3.1	P-2	8.95	8.95
1	14462	Diego Saves A Butterfly		Bergen, Lara	E	2007	1.4	P-1	8.95	8.95
1	25265	Diego Saves The Sloth!		Romay, Alexis	E	2007	2.3	P-2	8.95	8.95
1	10747	Diego Saves The Tree Frogs		Willson, Sarah	E	2006	1.0	P-1	8.95	8.95
1	27337	Diego's Birthday Surprise		Bergen, Lara	E	2008	1.2	P-1	8.95	8.95
1	23869	Diego's Buzzing Bee Adventure		Inches, Alison	F	2008	1.6	P-1	8.76	8.76
1	10745	Diego's Wolf Pup Rescue		Ricci, Christine	E	2006	3.3	P-2	8.95	8.95
1	791	Don't Go To Sleep		Stine, R. L.	F	1997	2.7	4-7	9.55	9.55
1	12020	Doom With A View!		McKeever, Sean	741.5	2007	2.8	2-5	14.95	14.95
1	23865	Dora And The Stuck Truck		Beinstein, Phoebe	E	2008	2.4	P-2	8.95	8.95
1	14451	Dora Climbs Star Mountain		Inches, Alison	E	2007	2.0	P-2	8.95	8.95
1	7609	Dora Goes To School		Valdes, Leslie	E	2004	2.4	P-2	8.95	8.95
1	25266	Dora Had A Little Lamb		Risco, Elle D.	E	2007	2.0	P-2	8.95	8.95
1	7610	Dora Loves Boots		Inches, Alison	E	2004	2.1	P-2	8.95	8.95
1	7614	Dora's Christmas Parade		Valdes, Leslie	E	2003	2.2	P-2	10.52	10.52

1	14450	Dora's World Adventure	 Nimm, Suzanne D. E	2006	2.5	P-2	8.95	8.95
1	81293	Double Dragon Trouble	 McMullan, Kate F	2005	3.4	2-5	9.74	9.74
1	12008	Duel To The Death With The Vulture	 Quantz, Daniel 741.5	2006	2.7	2-5	14.95	14.95
1	12009	Duel With Daredevil!	 Dezago, Todd 741.5	2006	2.7	2-5	14.95	14.95
1	21021	Dumpster Diver	 Wong, Janet S. E	2007	3.9	K-3	17.86	17.86
1	20167	Dust-Up In Aisle Seven!	 Van Lente, Fred 741.5	2007	2.8	2-5	14.95	14.95
1	10753	Earth	 Teitelbaum, Michael F	2006	5.6	3-6	9.74	9.74
1	84906	Earth Day-Hooray!	 Murphy, Stuart J. 513	2004	3.7	2-5	9.74	9.74
1	28771	Earth-Friendly Waste Management	 Wilcox, Charlotte 363.72	2009	5.7	4-7	22.95	22.95
1	3272808	Earth Friends At Home	 Galko, Francine 363.72	2004	3.6	1-4	21.56	21.56
1	3272791	Earth Friends At The Grocery Store	 Galko, Francine 363.72	2004	3.7	1-4	21.56	21.56
1	87583	El Cucuy! = A Bogeyman: Cuento In English And Spanish	 Hayes, Joe 398	2001	3.7	K-3	12.05	12.05
1	28523	Energy	 Fix, Alexandra 333.791	2008	4.4	1-4	12.08	12.08
1	23652	Energy From Wind, Sun, And Tides	 Muschal, Frank 621.31	2008	5.6	4-7	21.11	21.11
1	12015	Enforcers!	 Dezago, Todd 741.5	2006	3.2	2-5	14.95	14.95
1	4059100	Every Magic Secret In The World Revealed	 Lemezma, Marc 793	2005	6	4-7	16.96	16.96
1	12010	Face-To-Face With The Lizard!	 Quantz, Daniel 741.5	2006	2.5	2-5	14.95	14.95
1	12002	Fantastic Four: The Chameleon Strikes!	 Dezago, Todd 741.5	2006	3.1	2-5	14.95	14.95
1	12003	Fantastic Four: The Menace Of Monster Isle!	 Dezago, Todd 741.5	2006	3.4	2-5	14.95	14.95
1	20168	Fashion Victims	 Van Lente, Fred 741.5	2007	3.5	2-5	14.95	14.95
1	20158	Finding Zemo	 Parker, Jeff 741.5	2007	3.3	2-5	14.95	14.95





















1	10754	Fire		Mason, Tom	F	2006	5.0	3-6	9.74	9.74	
1	11975	Fun 'N' Games With The Fantastic Five!		DeFalco, Tom		741.5	2006	3.5	2-5	14.95	14.95
1	29360	Garbage And Recycling		Parks, Peggy J.		363.72	2008	5.5	5-12	23.95	23.95
1	116124	Ghost Beach		Stine, R. L.	F		1994	3.4	4-7	9.55	9.55
1	116251	Ghost Of Sir Herbert Dungeonstone		McMullan, Kate	F		2004	3.4	2-5	9.74	9.74
1	14459	Ghoul Hunters		Chanda, J-P	E		2005	3.0	K-3	8.95	8.95
1	117638	Girl Who Cried Monster		Stine, R. L.	F		1993	3.6	4-7	9.55	9.55
1	3089794	Go, Go, Go		Penguin Books Editors		428.6	2003		K-3	11.81	11.81
1	12021	Goom Got Game!		Parker, Jeff		741.5	2007	2.8	2-5	14.95	14.95
1	126429	Great Trash Bash		Leedy, Loreen	E		1991	2.6	K-3	18.61	18.61
1	127308	Green Monster		Murphy, Sonia	F		2004	2.3	K-3	8.95	8.95
1	12016	Grotesque Adventure Of The Green Goblin!		Raicht, Mike		741.5	2006	2.5	4-7	14.95	14.95
1	13805	Gum-Chewing Rattler		Hayes, Joe	E		2006	3.7	2-5	12.05	12.05
1	11992	Gus Beezer With Spider-Man		Simone, Gail		741.5	2006	2.6	2-5	14.95	14.95
1	11993	Gus Beezer With Spider-Man: Along Came A Spidey!		Simone, Gail		741.5	2006	2.9	2-5	14.95	14.95
1	11994	Gus Beezer With The Hulk		Simone, Gail		741.5	2006	2.6	2-5	14.95	14.95
1	11995	Gus Beezer With The X-Men: 'X' Marks The Mutant		Simone, Gail		741.5	2006	2.6	2-5	14.95	14.95
1	6569	Hail! Hail! Camp Dragononka!		McMullan, Kate	F		2006	3.4	2-5	10.52	10.52
1	7620	Happy Mother's Day, Mami!		Valdes, Leslie	E		2003	2.1	P-2	8.95	8.95
1	792	Haunted School		Stine, R. L.	F		1997	3.0	4-7	9.55	9.55
1	31471	Heart Of Steel		Van Lente, Fred		741.5	2008	3.8	2-5	14.95	14.95

1	3181149	Heat: Too Hot Or Too Cold?		Hewitt, Sally	536	2006	2.4	1-4	23.04	23.04	
1	133665	Help! It's Parents Day At DSA		McMullan, Kate F		2004	3.5	2-5	9.74	9.74	
1	133816	Henry And Mudge		Rylant, Cynthia	E	1987	2.7	K-3	8.95	8.95	
1	134046	Henry And Mudge And A Very Merry Christmas		Rylant, Cynthia	E	2004	2.9	K-3	8.95	8.95	
1	134023	Henry And Mudge And Annie's Good Move		Rylant, Cynthia	E	1998	2.3	K-3	8.95	8.95	
1	134022	Henry And Mudge And Annie's Perfect Pet		Rylant, Cynthia	E	2000	2.3	K-3	8.95	8.95	
1	134042	Henry And Mudge And Mrs. Hopper's House		Rylant, Cynthia	E	2003	2.8	K-3	8.95	8.95	
1	7444	Henry And Mudge And The Big Sleepover		Rylant, Cynthia	E	2006	2.5	K-3	8.95	8.95	
1	134052	Henry And Mudge And The Funny Lunch		Rylant, Cynthia	E	2004	2.7	K-3	8.95	8.95	
1	30158	Henry And Mudge And The Great Grandpas		Rylant, Cynthia	E	2005	2.6	K-3	8.95	8.95	
1	134030	Henry And Mudge And The Long Weekend		Rylant, Cynthia	E	1992	2.4	K-3	8.95	8.95	
1	3311124	Here Comes Santa		Wigand, Molly	E	2007	2.7	P-2	14.95	14.95	
1	12022	Here Comes Spider-Man		Fross, Kitty		741.5	2007	2.5	2-5	14.95	14.95
1	139507	Hot And Cold		Stille, Darlene R.	536	2001	3.6	2-5	16.95	16.95	
1	3179054	Hot And Cold		Lilly, Melinda	536	2006	3.3	1-4	18.15	18.15	
1	3940855	Hot And Cold		Jennings, Terry	536	2009	4.0	2-5	21.14	21.14	
1	1213	How I Learned To Fly		Stine, R. L.	F	1997	2.9	4-7	9.55	9.55	
1	144145	How To Kill A Monster		Stine, R. L.	F	1996	2.9	4-7	9.55	9.55	
1	31465	Hulks Take Manhattan		Benjamin, Paul	741.5	2008	3.2	2-5	14.95	14.95	
1	10746	Humpback Whale Tale		Spelvin, Justin	E	2006	2.4	P-2	8.95	8.95	
1	148361	I Am Spider-Man		Figuroa, Acton	E	2002	2.0	K-2	8.95	8.95	

Confirm Quote - Perma-Bound Books

1	5618	I'm So Embarrassed!	 Munsch, Robert N.	E	2005	2.5	K-3	9.74	9.74
1	31466	Is He Man Or Monster Or...Is He Both?	 Benjamin, Paul F	F	2008	2.8	2-5	14.95	14.95
1	159090	It Came From Beneath The Sink!	 Stine, R. L.	F	1995	3.1	4-7	9.55	9.55
1	14452	It's Sharing Day	 Larsen, Kirsten E		2007	2.4	P-2	8.95	8.95
1	160505	Jack And The Beanstalk	 Kellogg, Steven	398.21	1991	4.1	K-3	11.30	11.30
1	3089767	Jump And Run	 Penguin Books Editors	428.6	2003		K-3	11.81	11.81
1	166495	Junie B. Jones And A Little Monkey Business	 Park, Barbara	F	1993	2.9	1-4	9.74	9.74
1	166498	Junie B. Jones And Her Big Fat Mouth	 Park, Barbara	F	1993	3.0	1-4	9.74	9.74
1	166500	Junie B. Jones And Some Sneaky Pecky Spying	 Park, Barbara	F	1994	2.9	1-4	9.74	9.74
1	166504	Junie B. Jones And That Meanie Jim's Birthday	 Park, Barbara	F	1996	2.8	1-4	9.74	9.74
1	166499	Junie B. Jones And The Mushy Gushy Valentime	 Park, Barbara	F	1999	2.9	1-4	9.74	9.74
1	166505	Junie B. Jones And The Stupid Smelly Bus	 Park, Barbara	F	1992	2.9	1-4	9.74	9.74
1	166509	Junie B. Jones And The Yucky Blucky Fruitcake	 Park, Barbara	F	1995	2.7	1-4	9.74	9.74
1	166511	Junie B. Jones Has A Monster Under Her Bed	 Park, Barbara	F	1997	2.7	1-4	9.74	9.74
1	166503	Junie B. Jones Has A Peep In Her Pocket	 Park, Barbara	F	2000	2.9	1-4	9.74	9.74
1	166507	Junie B. Jones Is A Beauty Shop Guy	 Park, Barbara	F	1998	2.8	1-4	9.74	9.74
1	166494	Junie B. Jones Is A Graduation Girl	 Park, Barbara	F	2001	3.0	1-4	9.74	9.74
1	166513	Junie B. Jones Is A Party Animal	 Park, Barbara	F	1997	2.8	1-4	9.74	9.74
1	166506	Junie B. Jones Is (Almost) A Flower Girl	 Park, Barbara	F	1999	2.7	1-4	9.74	9.74
1	166517	Junie B. Jones Is Captain Field Day	 Park, Barbara	F	2001	2.8	1-4	9.74	9.74
1	166512	Junie B. Jones Is Not A Crook	 Park, Barbara	F	1997	3.0	1-4	9.74	9.74



















Confirm Quote - Perma-Bound Books

1	11997	Kitty Pride: Down With The Monsters!		Dezago, Todd	741.5	2006	2.6	2-5	14.95	14.95
1	172344	Knight For A Day		McMullan, Kate F		2003	3.4	2-5	9.74	9.74
1	12005	Kraven The Hunter		Raicht, Mike	741.5	2006	2.4	2-5	14.95	14.95
1	31786	Lasting Impressions		Disney Editors	741.5	2008	4	3-6	13.65	13.65
1	20159	Leader Has A Big Head		Parker, Jeff	741.5	2007	3.0	2-5	14.95	14.95
1	11982	Leader Of The Pack		Sumerak, Mark	741.5	2007	2.5	2-5	14.95	14.95
1	11974	Legacy... In Black And White		DeFalco, Tom	741.5	2006	3.5	2-5	14.95	14.95
1	3553871	Legend Of Sleepy Hollow		Van Nutt, Robert &	F	2005	5.9	1-4	17.95	17.95
1	175445	Let's Have A Play		Hillert, Margaret	E	1981	0.9	P-2	12.48	12.48
1	8444	Let's Recycle!		Mackenzie, Anne L.	363.72	2007	2.6	P-2	12.95	12.95
1	8445	Let's Reduce Garbage!		Nelson, Sara E.	363.72	2007	1.8	P-2	12.95	12.95
1	8446	Let's Reuse!		Nelson, Sara E.	363.72	2007	1.7	P-2	12.95	12.95
1	17652	Little Giant - Big Trouble		McMullan, Kate F		2007	3.3	2-5	9.74	9.74
1	178069	Little Gold Star = Estrellita De Oro: A Cinderella Cuento		Hayes, Joe	E	2000	3.9	K-3	12.05	12.05
1	183311	Louie		Keats, Ezra Jack	E	1975	1.7	P-3	11.30	11.30
1	4374	Lucky Days With Mr. And Mrs. Green		Baker, Keith	F	2005	2.6	1-4	10.49	10.49
1	12023	Make Mine Mysterio!		McKeever, Sean	741.5	2007	2.8	2-5	14.95	14.95
1	12017	Man Called Electro!		Dezago, Todd	741.5	2006	3.0	2-5	14.95	14.95
1	3177984	Marco Polo		Petrie, Kristin	092	2007	5.1	2-5	16.95	16.95
1	12011	Marked For Destruction By Dr. Doom!		Quantz, Daniel	741.5	2006	2.7	2-5	14.95	14.95
1	20160	Masters Of Evil		Parker, Jeff	741.5	2007	3.6	2-5	14.95	14.95





















Confirm Quote - Perma-Bound Books

1	31467	Mayhem!		Benjamin, Paul	741.5	2008	3.2	2-5	14.95	14.95
1	194189	Meet Mr. And Mrs. Green		Baker, Keith	E	2004	2.7	1-4	10.49	10.49
1	12018	Menace Of Mysterio		Raicht, Mike	741.5	2006	2.7	2-5	14.95	14.95
1	11983	Mind Over Matter		Sumerak, Mark	741.5	2007	3.0	2-5	14.95	14.95
1	200428	Monster Blood		Stine, R. L.	F	1992	4.1	4-7	10.32	10.32
1	13655	Monster Blood III		Stine, R. L.	F	1995	3.2	4-7	9.55	9.55
1	201875	More Mr. And Mrs. Green		Baker, Keith	E	2004	2.6	1-4	10.49	10.49
1	17026	My Best Friend Is Invisible		Stine, R. L.	F	1993	2.8	4-7	9.55	9.55
1	10603	My Hairiest Adventure		Stine, R. L.	F	1994	3.5	4-7	9.55	9.55
1	11083	Never Trust A Troll!		McMullan, Kate	F	2006	3.4	2-5	9.74	9.74
1	212944	New Kid At School		McMullan, Kate	F	2003	3.3	2-5	9.74	9.74
1	214648	Night In Terror Tower		Stine, R. L.	F	1995	3.5	4-7	9.55	9.55
1	214865	Night Of The Living Dummy		Stine, R. L.	F	1993	3.7	4-7	10.32	10.32
1	3942309	North Wind And The Sun		Nash, Margaret	E	2009	1.6	1-4	20.01	20.01
1	12012	Nothing Can Stop The Sandman!		Quantz, Daniel	741.5	2006	2.8	2-5	14.95	14.95
1	18737	On The Go With Mr. And Mrs. Green		Baker, Keith	F	2006	2.7	1-4	10.49	10.49
1	3187964	Pajaro Verde = Green Bird		Hayes, Joe	398	2002	3.7	2-5	14.41	14.41
1	12024	Picture-Perfect Peril!		McKeever, Sean	741.5	2007	2.9	2-5	14.95	14.95
1	234944	Pig Latin - Not Just For Pigs		McMullan, Kate	F	2005	3.4	2-5	9.74	9.74
1	3553880	Pinocchio		Metaxas, Eric & Collodi, Carlo	E	2005	4.9	1-4	17.95	17.95
1	12025	Power Struggle		McKeever, Sean	741.5	2007	2.6	2-5	14.95	14.95

Confirm Quote - Perma-Bound Books

1	17760	Prairie Dog Rescue		Ricci, Christine E	2007	1.8	P-1	8.95	8.95
1	12026	Prison Break		David, Erica	741.5	2007	2.5	2-5	14.95 14.95
1	18864	Pteranodon: The Giant Of The Sky		West, David; Riley, Terry & Ball, Geoff	567.918	2008	4.4	2-5	18.94 18.94
1	245995	Purple Green And Yellow		Munsch, Robert	E	1992	3.2	K-3	10.49 10.49
1	31468	Radioactive		Benjamin, Paul	741.5	2008	3.6	2-5	14.95 14.95
1	22447	Raven-Symone		Leavitt, Amie Jane	092	2008	4.8	2-4	19.28 19.28
1	20161	Replacements		Parker, Jeff	741.5	2007	3.6	2-5	14.95 14.95
1	10751	Rescue Patrol		Lukas, Catherine	E	2006	1.4	P-1	8.95 8.95
1	5625	Return Of The Mummy		Stine, R. L.	F	1994	3.8	4-7	9.55 9.55
1	26098	Revenge Of The Dragon Lady		McMullan, Kate	F	2003	3.1	2-5	9.74 9.74
1	2491	Riding The Range		Spelvin, Justin	E	2006	1.7	P-1	8.95 8.95
1	3551613	Rip Van Winkle		Meyerowitz, Rick & Irving, Washington	F	2004	4.5	1-4	17.95 17.95
1	2489	Royal Valentine		Wax, Wendy	E	2006	1.5	P-1	8.95 8.95
1	3311133	Rugrats Blast Off		St. Pierre, Stephanie	E	2007	2.9	P-2	14.95 14.95
1	12027	Rush Hour!		McKeever, Sean	741.5	2007	2.5	2-5	14.95 14.95
1	260941	Say Cheese And Die!		Stine, R. L.	F	1992	3.9	4-7	7.20 7.20
1	265104	Secret		Murphy, Stephen & Sonia	F	2004	2.6	K-3	8.95 8.95
1	31750	Secrets And Super Sneaks		Disney Editors	741.5	2007	3	3-6	12.08 12.08
1	12028	Sinister Six!		David, Erica	741.5	2007	2.6	2-5	14.95 14.95
1	272397	Sir Lancelot, Where Are You?		McMullan, Kate	F	2003	3.0	2-5	9.74 9.74

Confirm Quote - Perma-Bound Books

1	273639	Skippyjon Jones		Schachner, Judith Byron	E	2003	3.3	K-3	10.52	10.52
1	22021	Skippyjon Jones And The Big Bones (Includes CD)		Schachner, Judith Byron	E	2007	3.5	K-3	17.86	17.86
1	11020	Skippyjon Jones In Mummy Trouble		Schachner, Judith Byron	E	2006	3.8	K-3	11.30	11.30
1	1789	Skippyjon Jones In The Doghouse		Schachner, Judith Byron	E	2005	3.8	K-3	11.30	11.30
1	27338	Sokka, The Sword Master		Gerstein, Sherry	F	2008	3.6	1-4	8.95	8.95
1	3089758	Something Funny		Penguin Books Editors		428.6	2003		K-3 11.81	11.81
1	11970	Spider-Girl Battles The Deadly Dragon King		DeFalco, Tom		741.5	2006	3.4	2-5 14.95	14.95
1	6416	Spider-Man: The Amazing Story		Saunders, Catherine	E		2006	3.0	P-2 8.95	8.95
1	12007	Spider-Man Versus Doctor Octopus		Quantz, Daniel		741.5	2006	2.9	2-5 14.95	14.95
1	12013	Spidey Strikes Back!		Dezago, Todd		741.5	2006	2.7	2-5 14.95	14.95
1	124	Spoon For Every Bite = Cada Bocado Con Nueva Cuchara		Hayes, Joe		398	2005	3.7	K-3 12.83	12.83
1	12000	Storm: Change The Weather		Dezago, Todd		741.5	2006	2.6	2-5 14.95	14.95
1	291640	Take A Bow, Babies!		Gold, Rebecca	E		2000	2.4	K-3 8.95	8.95
1	293906	Tell Me A Cuento = Cuéntame Un Story: A Bilingual Storybook		Hayes, Joe	E		1998	2.9	2-5 15.17	15.17
1	3311142	Thank You, Angelica		Schoberle, Cecile	E		2007	2.4	P-2 14.95	14.95
1	12001	Thor: Out Of Time!		Dezago, Todd		741.5	2006	3.9	2-5 14.95	14.95
1	17767	Three Wishes		Lukas, Catherine	E		2007	1.2	P-1 8.95	8.95
1	3708651	Tommy's Last Stand		Krulik, Nancy	F		1999	3.4	1-4 10.03	10.03
1	3311151	Tommy's New Playmate		David, Luke	E		2007	3.1	P-2 14.95	14.95
1	11971	Touch Of Venom		DeFalco, Tom		741.5	2006	3.5	2-5 14.95	14.95
1	18866	Triceratops: The Three-Horned		Shone, Rob; Riley, Terry &		567.915	2008	3.7	2-5 18.94	18.94

Dinosaur		Author	Level	Date	Dewey	ATOS	Pts	Price*	Total
1	14453	Trouble On The Train	E	2007	2.1	P-1	8.95	8.95	
1	307517	Turtle Rescue!	F	2004	2.7	K-3	8.95	8.95	
1	18867	Tyrannosaurus: The Tyrant Lizard	E	567.912 2008	3.1	2-5	18.94	18.94	
1	313227	Up And Away Reptar	E	1999	2.1	K-3	8.95	8.95	
1	18868	Velociraptor: The Speedy Thief	E	567.912 2008	3.4	2-5	18.94	18.94	
1	10755	Water	F	2006	5.1	3-6	9.74	9.74	
1	3092398	We Play	E	428.3 2004	0.7	K-3	14.95	14.95	
1	3092389	We Work	E	2004	1.4	K-3	14.95	14.95	
1	322259	Wedding For Wiglaf?	F	2003	3.1	2-5	9.74	9.74	
1	322490	Weeping Woman = La Llorona	F	398 1987	4.3	4-7	12.05	12.05	
1	13661	Welcome To Treeville!: A Rugrats Christmas	E	2004	2.1	K-3	8.95	8.95	
1	325591	Wheel Of Misfortune	F	2003	3.5	2-5	9.74	9.74	
1	2330	World's Oldest Living Dragon	F	2006	3.7	2-5	9.74	9.74	
1	215631	97 Ways To Train A Dragon	F	2003	3.3	2-5	9.74	9.74	

Quizzes:

Qty.	Quiz #	Title	Author	Dewey	Date	ATOS	Pts	Price*	Total
1	123786	Aang's School Days	Teitelbaum, Michael	F	2008	3.3	0.5	2.99	2.99
1	51654	Aaron's Hair	Munsch, Robert	E	2000	2.4	0.5	2.99	2.99
1	104797	Abomination!	Raicht, Mike	741.5	2006	2.6	0.5	2.99	2.99
1	114003	Air	Mason, Tom	F	2006	4.7	1.0	2.99	2.99
1	49476	Andrew's Loose Tooth	Munsch, Robert	E	1998	2.8	0.5	2.99	2.99
1	87926	Babar The Magician	Brunhoff, Laurent De	E	2005	2.1	0.5	2.99	2.99
1	106969	Baby Coyote And The Old Woman = Bel Coyotito Y La Viejita	Tafolla, Carmen	E	2000	3.9	0.5	2.99	2.99
1	112134	Back Off, Bully Boys!	Richards, Kitty	E	2007	2.9	0.5	2.99	2.99
1	43242	Beady Bear	Freeman, Don	E	1977	3.0	0.5	2.99	2.99
1	9004	Bear Detectives	Berenstain, Stan & Jan	E	1975	2.2	0.5	2.99	2.99

1	9008	Bears' Picnic	Berenstain, Stan & Jan	E	1966	1.9	0.5	2.99	2.99
1	9007	Bears' Vacation	Berenstain, Stan & Jan	E	1968	2.0	0.5	2.99	2.99
1	42381	Beasty Story	Martin, Bill, Jr. & Kellogg, Steven	E	1999	1.6	0.5	2.99	2.99
1	105252	Bedeviled	DeFalco, Tom	741.5	2006	3.6	0.5	2.99	2.99
1	7452	Berenstain Bears And Mama's New Job	Berenstain, Stan & Jan	E	1984	3.9	0.5	2.99	2.99
1	101635	Berenstain Bears And The Baby Chipmunk	Berenstain, Stan & Jan	E	2005	2.1	0.5	2.99	2.99
1	7455	Berenstain Bears And The Big Road Race	Berenstain, Stan & Jan	E	1987	1.7	0.5	2.99	2.99
1	7355	Best Friends	Kellogg, Steven	E	1986	3.4	0.5	2.99	2.99
1	85620	Beware! It's Friday The 13th	McMullan, Kate	F	2005	3.3	1.0	2.99	2.99
1	14936	Beware, The Snowman	Stine, R. L.	F	1997	3.2	2.0	2.99	2.99
1	104795	Big Green Men	Raicht, Mike	741.5	2006	2.5	0.5	2.99	2.99
1	109924	Big Trouble At The Big Top	Sumerak, Marc	741.5	2007	2.6	0.5	2.99	2.99
1	109008	Birthday Dance Party: Daisy's Fiesta De Quinceanera	Inches, Alison	E	2006	2.4	0.5	2.99	2.99
1	82636	Boo!	Munsch, Robert	E	2004	3.3	0.5	2.99	2.99
1	6105	Boy In The Drawer	Munsch, Robert	E	1986	2.7	0.5	2.99	2.99
1	116993	Breaking Up Is Venomous To Do!	Van Lente, Fred	741.5	2007	3.6	0.5	2.99	2.99
1	116993	Breaking Up Is Venomous To Do!	Van Lente, Fred	741.5	2007	3.6	0.5	2.99	2.99
1	104794	Bugs	Raicht, Mike	741.5	2006	2.4	0.5	2.99	2.99
1	30744	Can I Keep Him?	Kellogg, Steven	E	1971	2.7	0.5	2.99	2.99
1	105269	Captain America: Stars, Stripes, And Spiders	Dezago, Todd	741.5	2006	3.6	0.5	2.99	2.99
1	56885	Card Tricks	Klingel, Cynthia & Noyed, Robert	793.8	2002	4.0	0.5	2.99	2.99
1	74076	Case Of The Burrowing Robot	Erickson, John R.	F	2003	4.3	3.0	2.99	2.99
1	28733	Case Of The Measled Cowboy	Erickson, John R.	F	1999	4.4	3.0	2.99	2.99
1	10657	Case Of The Midnight Rustler	Erickson, John R.	F	1992	5.5	3.0	2.99	2.99
1	61470	Case Of The Missing Bird Dog	Erickson, John R.	F	2002	4.2	3.0	2.99	2.99
1	7707	Case Of The Missing Cat	Erickson, John R.	F	1990	4.8	3.0	2.99	2.99
1	107296	Case Of The Monkey Burglar	Erickson, John R.	F	2006	4.3	3.0	2.99	2.99
1	7708	Case Of The One-Eyed Killer Stud Horse	Erickson, John R.	F	1989	5.1	3.0	2.99	2.99
1	43144	Case Of The Raging Rottweiler	Erickson, John R.	F	2000	4.3	3.0	2.99	2.99
1	43145	Case Of The Saddle House Robbery	Erickson, John R.	F	2000	4.4	3.0	2.99	2.99
1	104497	Castaways!	Inches, Alison	E	2006	1.2	0.5	2.99	2.99
1	29958	Chicken Little	Kellogg, Steven	E	1985	3.8	0.5	2.99	2.99
1	105253	Choices	DeFalco, Tom	741.5	2006	4.0	0.5	2.99	2.99
1	112135	Chuckie's New Mommy	Ostrow, Kim	E	2007	2.9	0.5	2.99	2.99
1	36461	Class Trip To The Cave Of Doom	McMullan, Kate	F	2003	2.7	1.0	2.99	2.99
1	104760	Coming Of The Scorpion!	Raicht, Mike	741.5	2006	2.8	0.5	2.99	2.99
1	5464	Corduroy	Freeman, Don	E	1968	3.5	0.5	2.99	2.99

Confirm Quote - Perma-Bound Books

1	106375	Corduroy Goes To The Beach	Hennessy, B. G. & Freeman, E Don	1995	2.1	0.5	2.99	2.99
1	109925	Costumes On!	Sumerak, Mark	741.5	2007	2.6	0.5	2.99
1	41243	Countdown To The Year 1000	McMullan, Kate F		2003	3.5	2.0	2.99
1	104796	Cowboys And Robots	Raicht, Mike	741.5	2006	2.2	0.5	2.99
1	123766	Creeping Doom	Van Lente, Fred	741.5	2008	3.5	0.5	2.99
1	78841	Danger! Wizard At Work	McMullan, Kate F		2004	3.4	1.0	2.99
1	8006	Dark	Munsch, Robert	E	1979	2.7	0.5	2.99
1	121699	Diego And Mami To The Rescue!	Romay, Alexis	E	2008	2.7	0.5	2.99
1	114364	Diego And Papi To The Rescue	Wax, Wendy	E	2007	3.1	0.5	2.99
1	123065	Diego And The Baby Sea Turtles	Rao, Lisa	E	2008	3.1	0.5	2.99
1	114577	Diego Saves A Butterfly	Bergen, Lara	E	2007	1.4	0.5	2.99
1	115115	Diego Saves The Sloth!	Romay, Alexis	E	2007	2.3	0.5	2.99
1	112030	Diego Saves The Tree Frogs	Willson, Sarah	E	2006	1.0	0.5	2.99
1	123790	Diego's Birthday Surprise	Bergen, Lara	E	2008	1.2	0.5	2.99
1	120683	Diego's Buzzing Bee Adventure	Inches, Alison	F	2008	1.6	0.5	2.99
1	110942	Diego's Wolf Pup Rescue	Ricci, Christine	E	2006	3.3	0.5	2.99
1	109888	Doom With A View!	McKeeever, Sean	741.5	2007	2.8	0.5	2.99
1	121385	Dora And The Stuck Truck	Beinstein, Phoebe	E	2008	2.4	0.5	2.99
1	116204	Dora Climbs Star Mountain	Inches, Alison	E	2007	2.0	0.5	2.99
1	84089	Dora Goes To School	Valdes, Leslie	E	2004	2.4	0.5	2.99
1	116205	Dora Had A Little Lamb	Risco, Elle D.	E	2007	2.0	0.5	2.99
1	88927	Dora Loves Boots	Inches, Alison	E	2004	2.1	0.5	2.99
1	83482	Dora's Christmas Parade	Valdes, Leslie	E	2003	2.2	0.5	2.99
1	116206	Dora's World Adventure	Nimm, Suzanne D.	E	2006	2.5	0.5	2.99
1	104043	Double Dragon Trouble	McMullan, Kate F		2005	3.4	2.0	2.99
1	105404	Duel To The Death With The Vulture	Quantz, Daniel	741.5	2006	2.7	0.5	2.99
1	105405	Duel With Daredevil!	Dezago, Todd	741.5	2006	2.7	0.5	2.99
1	112407	Dumpster Diver	Wong, Janet S.	E	2007	3.9	0.5	2.99
1	116994	Dust-Up In Aisle Seven!	Van Lente, Fred	741.5	2007	2.8	0.5	2.99
1	114004	Earth	Teitelbaum, Michael	F	2006	5.6	1.0	2.99
1	76198	Earth Day-Hooray!	Murphy, Stuart J.	513	2004	3.7	0.5	2.99
1	124252	Earth-Friendly Waste Management	Wilcox, Charlotte	363.72	2009	5.7	2.0	2.99
1	78339	Earth Friends At Home	Galko, Francine	363.72	2004	3.6	0.5	2.99
1	78342	Earth Friends At The Grocery Store	Galko, Francine	363.72	2004	3.7	0.5	2.99
1	118328	Energy	Fix, Alexandra	333.791	2008	4.4	0.5	2.99
1	117881	Energy From Wind, Sun, And Tides	Muschal, Frank	621.31	2008	5.6	0.5	2.99
1	104761	Enforcers!	Dezago, Todd	741.5	2006	3.2	0.5	2.99
1	105406	Face-To-Face With The Lizard!	Quantz, Daniel	741.5	2006	2.5	0.5	2.99
1	105267	Fantastic Four: The Chameleon Strikes!	Dezago, Todd	741.5	2006	3.1	0.5	2.99
1	105271	Fantastic Four: The Menace Of Monster Isle!	Dezago, Todd	741.5	2006	3.4	0.5	2.99
1	116995	Fashion Victims	Van Lente, Fred	741.5	2007	3.5	0.5	2.99
1	116961	Finding Zemo	Parker, Jeff	741.5	2007	3.3	0.5	2.99
1	112064	Fire	Mason, Tom	F	2006	5.0	1.0	2.99
1	105254	Fun 'N' Games With The Fantastic Five!	DeFalco, Tom	741.5	2006	3.5	0.5	2.99

1	121459	Garbage And Recycling	Parks, Peggy J.	363.72	2008	5.5	1.0	2.99	2.99
1	82273	Ghost Of Sir Herbert Dungeonstone	McMullan, Kate F		2004	3.4	1.0	2.99	2.99
1	101249	Ghoul Hunters	Chanda, J-P E		2005	3.0	0.5	2.99	2.99
1	109889	Goom Got Game!	Parker, Jeff	741.5	2007	2.8	0.5	2.99	2.99
1	21513	Great Trash Bash	Leedy, Loreen E		1991	2.6	0.5	2.99	2.99
1	77959	Green Monster	Murphy, Sonia F		2004	2.3	0.5	2.99	2.99
1	104762	Grotesque Adventure Of The Green Goblin!	Raicht, Mike	741.5	2006	2.5	0.5	2.99	2.99
1	105287	Gus Beezer With Spider-Man	Simone, Gail	741.5	2006	2.6	0.5	2.99	2.99
1	105288	Gus Beezer With Spider-Man: Along Came A Spidey!	Simone, Gail	741.5	2006	2.9	0.5	2.99	2.99
1	105289	Gus Beezer With The Hulk	Simone, Gail	741.5	2006	2.6	0.5	2.99	2.99
1	105290	Gus Beezer With The X-Men: 'X' Marks The Mutant	Simone, Gail	741.5	2006	2.6	0.5	2.99	2.99
1	107850	Hail! Hail! Camp Dragononka!	McMullan, Kate F		2006	3.4	3.0	2.99	2.99
1	79389	Happy Mother's Day, Mami!	Valdes, Leslie E		2003	2.1	0.5	2.99	2.99
1	123761	Heart Of Steel	Van Lente, Fred	741.5	2008	3.8	0.5	2.99	2.99
1	110995	Heat: Too Hot Or Too Cold?	Hewitt, Sally	536	2006	2.4	0.5	2.99	2.99
1	76209	Help! It's Parents Day At DSA	McMullan, Kate F		2004	3.5	2.0	2.99	2.99
1	7572	Henry And Mudge	Rylant, Cynthia E		1987	2.7	0.5	2.99	2.99
1	82322	Henry And Mudge And A Very Merry Christmas	Rylant, Cynthia E		2004	2.9	0.5	2.99	2.99
1	24965	Henry And Mudge And Annie's Good Move	Rylant, Cynthia E		1998	2.3	0.5	2.99	2.99
1	35182	Henry And Mudge And Annie's Perfect Pet	Rylant, Cynthia E		2000	2.3	0.5	2.99	2.99
1	68254	Henry And Mudge And Mrs. Hopper's House	Rylant, Cynthia E		2003	2.8	0.5	2.99	2.99
1	107040	Henry And Mudge And The Big Sleepover	Rylant, Cynthia E		2006	2.5	0.5	2.99	2.99
1	77594	Henry And Mudge And The Funny Lunch	Rylant, Cynthia E		2004	2.7	0.5	2.99	2.99
1	87210	Henry And Mudge And The Great Grandpas	Rylant, Cynthia E		2005	2.6	0.5	2.99	2.99
1	13396	Henry And Mudge And The Long Weekend	Rylant, Cynthia E		1992	2.4	0.5	2.99	2.99
1	112136	Here Comes Santa	Wigand, Molly E		2007	2.7	0.5	2.99	2.99
1	109890	Here Comes Spider-Man	Fross, Kitty	741.5	2007	2.5	0.5	2.99	2.99
1	45168	Hot And Cold	Stille, Darlene R.	536	2001	3.6	0.5	2.99	2.99
1	89731	Hot And Cold	Lilly, Melinda	536	2006	3.3	0.5	2.99	2.99
1	125041	Hot And Cold	Jennings, Terry	536	2009	4.0	0.5	2.99	2.99
1	123767	Hulks Take Manhattan	Benjamin, Paul	741.5	2008	3.2	0.5	2.99	2.99
1	112028	Humpback Whale Tale	Spelvin, Justin E		2006	2.4	0.5	2.99	2.99
1	59513	I Am Spider-Man	Figueroa, Acton E		2002	2.0	0.5	2.99	2.99
1	106650	I'm So Embarrassed!	Munsch, Robert N. E		2005	2.5	0.5	2.99	2.99
1	123763	Is He Man Or Monster Or...Is He Both?	Benjamin, Paul F		2008	2.8	0.5	2.99	2.99
1	116208	It's Sharing Day	Larsen, Kirsten E		2007	2.4	0.5	2.99	2.99
1	6323	Junie B. Jones And A Little Monkey Business	Park, Barbara F		1993	2.9	1.0	2.99	2.99
1	14677	Junie B. Jones And That Meanie Jim's Birthday	Park, Barbara F		1996	2.8	1.0	2.99	2.99
1	17572	Junie B. Jones Is Not A Crook	Park, Barbara F		1997	3.0	1.0	2.99	2.99
1	105270	Kitty Pride: Down With The Monsters!	Dezago, Todd	741.5	2006	2.6	0.5	2.99	2.99
1	36463	Knight For A Day	McMullan, Kate F		2003	3.4	2.0	2.99	2.99

Confirm Quote - Perma-Bound Books

1	104759	Kraven The Hunter	Raicht, Mike	741.5	2006	2.4	0.5	2.99	2.99
1	116962	Leader Has A Big Head	Parker, Jeff	741.5	2007	3.0	0.5	2.99	2.99
1	109928	Leader Of The Pack	Sumerak, Mark	741.5	2007	2.5	0.5	2.99	2.99
1	105255	Legacy... In Black And White	DeFalco, Tom	741.5	2006	3.5	0.5	2.99	2.99
1	85497	Legend Of Sleepy Hollow	Van Nutt, Robert & Hillert, Margaret	F	2005	5.9	0.5	2.99	2.99
1	9377	Let's Have A Play	Mackenzie, Anne L.	E	1981	0.9	0.5	2.99	2.99
1	107653	Let's Recycle!	Nelson, Sara E.	363.72	2007	2.6	0.5	2.99	2.99
1	107654	Let's Reduce Garbage!	Nelson, Sara E.	363.72	2007	1.8	0.5	2.99	2.99
1	107655	Let's Reuse!	McMullan, Kate F	363.72	2007	1.7	0.5	2.99	2.99
1	114855	Little Giant - Big Trouble	Keats, Ezra Jack	F	2007	3.3	2.0	2.99	2.99
1	73894	Louie	Baker, Keith	E	1975	1.7	0.5	2.99	2.99
1	84514	Lucky Days With Mr. And Mrs. Green	Baker, Keith	F	2005	2.6	0.5	2.99	2.99
1	109891	Make Mine Mysterio!	McKeever, Sean	741.5	2007	2.8	0.5	2.99	2.99
1	104763	Man Called Electro!	Dezago, Todd	741.5	2006	3.0	0.5	2.99	2.99
1	112074	Marco Polo	Petrie, Kristin	092	2007	5.1	0.5	2.99	2.99
1	105407	Marked For Destruction By Dr. Doom!	Quantz, Daniel	741.5	2006	2.7	0.5	2.99	2.99
1	116963	Masters Of Evil	Parker, Jeff	741.5	2007	3.6	0.5	2.99	2.99
1	123764	Mayhem!	Benjamin, Paul	741.5	2008	3.2	0.5	2.99	2.99
1	64202	Meet Mr. And Mrs. Green	Baker, Keith	E	2004	2.7	0.5	2.99	2.99
1	104764	Menace Of Mysterio	Raicht, Mike	741.5	2006	2.7	0.5	2.99	2.99
1	109929	Mind Over Matter	Sumerak, Mark	741.5	2007	3.0	0.5	2.99	2.99
1	76153	More Mr. And Mrs. Green	Baker, Keith	E	2004	2.6	0.5	2.99	2.99
1	111087	Never Trust A Troll!	McMullan, Kate F	F	2006	3.4	2.0	2.99	2.99
1	36459	New Kid At School	McMullan, Kate F	F	2003	3.3	1.0	2.99	2.99
1	124807	North Wind And The Sun	Nash, Margaret	E	2009	1.6	0.5	2.99	2.99
1	105408	Nothing Can Stop The Sandman!	Quantz, Daniel	741.5	2006	2.8	0.5	2.99	2.99
1	106491	On The Go With Mr. And Mrs. Green	Baker, Keith	F	2006	2.7	0.5	2.99	2.99
1	109892	Picture-Perfect Peril!	McKeever, Sean	741.5	2007	2.9	0.5	2.99	2.99
1	89126	Pig Latin - Not Just For Pigs	McMullan, Kate F	F	2005	3.4	2.0	2.99	2.99
1	85531	Pinocchio	Metaxas, Eric & Collodi, Carlo	E	2005	4.9	0.5	2.99	2.99
1	109893	Power Struggle	McKeever, Sean	741.5	2007	2.6	0.5	2.99	2.99
1	116196	Prairie Dog Rescue	Ricci, Christine	E	2007	1.8	0.5	2.99	2.99
1	109894	Prison Break	David, Erica	741.5	2007	2.5	0.5	2.99	2.99
1	118115	Pteranodon: The Giant Of The Sky	West, David; Riley, Terry & Ball, Geoff	567.918	2008	4.4	0.5	2.99	2.99
1	123765	Radioactive	Benjamin, Paul	741.5	2008	3.6	0.5	2.99	2.99
1	119543	Raven-Symone	Leavitt, Amie Jane	092	2008	4.8	0.5	2.99	2.99
1	116964	Replacements	Parker, Jeff	741.5	2007	3.6	0.5	2.99	2.99
1	116197	Rescue Patrol	Lukas, Catherine	E	2006	1.4	0.5	2.99	2.99
1	36460	Revenge Of The Dragon Lady	McMullan, Kate F	F	2003	3.1	1.0	2.99	2.99
1	104862	Riding The Range	Spelvin, Justin	E	2006	1.7	0.5	2.99	2.99
1	78513	Rip Van Winkle	Meyerowitz, Rick & Irving,	F	2004	4.5	0.5	2.99	2.99

1	104495	Royal Valentine	Washington Wax, Wendy	E	2006	1.5	0.5	2.99	2.99
1	112137	Rugrats Blast Off	St. Pierre, Stephanie	E	2007	2.9	0.5	2.99	2.99
1	109895	Rush Hour!	McKeever, Sean	741.5	2007	2.5	0.5	2.99	2.99
1	77961	Secret	Murphy, Stephen & Sonia	F	2004	2.6	0.5	2.99	2.99
1	109896	Sinister Six!	David, Erica	741.5	2007	2.6	0.5	2.99	2.99
1	36464	Sir Lancelot, Where Are You?	McMullan, Kate	F	2003	3.0	1.0	2.99	2.99
1	76674	Skippyjon Jones	Schachner, Judith Byron	E	2003	3.3	0.5	2.99	2.99
1	118093	Skippyjon Jones And The Big Bones (Includes CD)	Schachner, Judith Byron	E	2007	3.5	0.5	2.99	2.99
1	110490	Skippyjon Jones In Mummy Trouble	Schachner, Judith Byron	E	2006	3.8	0.5	2.99	2.99
1	89239	Skippyjon Jones In The Doghouse	Schachner, Judith Byron	E	2005	3.8	0.5	2.99	2.99
1	123801	Sokka, The Sword Master	Gerstein, Sherry	F	2008	3.6	0.5	2.99	2.99
1	105251	Spider-Girl Battles The Deadly Dragon King	DeFalco, Tom	741.5	2006	3.4	0.5	2.99	2.99
1	113788	Spider-Man: The Amazing Story	Saunders, Catherine	E	2006	3.0	0.5	2.99	2.99
1	105409	Spider-Man Versus Doctor Octopus	Quantz, Daniel	741.5	2006	2.9	0.5	2.99	2.99
1	105410	Spidey Strikes Back!	Dezago, Todd	741.5	2006	2.7	0.5	2.99	2.99
1	105265	Storm: Change The Weather	Dezago, Todd	741.5	2006	2.6	0.5	2.99	2.99
1	49915	Take A Bow, Babies!	Gold, Rebecca	E	2000	2.4	0.5	2.99	2.99
1	23986SP	Tell Me A Cuento = Cuentame Un Story: A Bilingual Storybook	Hayes, Joe	E	1998	2.9	0.5	2.99	2.99
1	112138	Thank You, Angelica	Schoberle, Cecile	E	2007	2.4	0.5	2.99	2.99
1	105272	Thor: Out Of Time!	Dezago, Todd	741.5	2006	3.9	0.5	2.99	2.99
1	116199	Three Wishes	Lukas, Catherine	E	2007	1.2	0.5	2.99	2.99
1	31242	Tommy's Last Stand	Krulik, Nancy	F	1999	3.4	1.0	2.99	2.99
1	112139	Tommy's New Playmate	David, Luke	E	2007	3.1	0.5	2.99	2.99
1	105250	Touch Of Venom	DeFalco, Tom	741.5	2006	3.5	0.5	2.99	2.99
1	118116	Triceratops: The Three-Horned Dinosaur	Shone, Rob; Riley, Terry & Ball, Geoff	567.915	2008	3.7	0.5	2.99	2.99
1	114587	Trouble On The Train	Lukas, Catherine	E	2007	2.1	0.5	2.99	2.99
1	78821	Turtle Rescue!	Chanda, J-P	F	2004	2.7	0.5	2.99	2.99
1	118117	Tyrannosaurus: The Tyrant Lizard	Shone, Rob & Field, James	567.912	2008	3.1	0.5	2.99	2.99
1	49928	Up And Away Reptar	Willson, Sarah	E	1999	2.1	0.5	2.99	2.99
1	118118	Velociraptor: The Speedy Thief	West, David & Field, James	567.912	2008	3.4	0.5	2.99	2.99
1	112065	Water	Teitelbaum, Michael	F	2006	5.1	1.0	2.99	2.99
1	76433	We Play	Grosset and Dunlap Editors	428.3	2004	0.7	0.5	2.99	2.99
1	76435	We Work	Grosset and Dunlap Editors	E	2004	1.4	0.5	2.99	2.99
1	36462	Wedding For Wiglaf?	McMullan, Kate	F	2003	3.1	1.0	2.99	2.99
1	82331	Welcome To Treeville!: A Rugrats Christmas	Miglis, Jenny	E	2004	2.1	0.5	2.99	2.99
1	36465	Wheel Of Misfortune	McMullan, Kate	F	2003	3.5	2.0	2.99	2.99
1	104968	World's Oldest Living Dragon	McMullan, Kate	F	2006	3.7	2.0	2.99	2.99
1	76205	97 Ways To Train A Dragon	McMullan, Kate	F	2003	3.3	2.0	2.99	2.99

***Prices subject to change without notice**



Exhibit A

**United Independent School District
Board of Trustees Discretionary Funds Request Form
Fiscal Year 2008-2009**

Requesting Campus: Nye Elementary School

Campus Principal: Patricia E. Lañas

Board Member: Juan Roberto Ramirez

Board Member: _____

Description of Request: • Eiki Lamps for projectors
teachers use for instruction in the classrooms.
Teachers use projectors to model for
students and as part of their direct teach.

Estimated Cost of Request 2,842.18

Principal Signature: Patricia E. Lañas Date 12-3-08

Board Member Approval: Yes No

Board Member Signature: _____ Date _____

Board Member Signature: _____ Date _____

Superintendent Signature: _____ Date _____

Board Approval: Yes No Date Approved: _____

Please return the completed form to the Superintendent's Office for final processing.

